

MRH 125

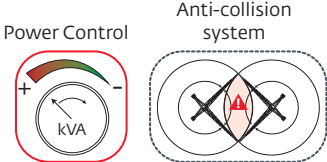
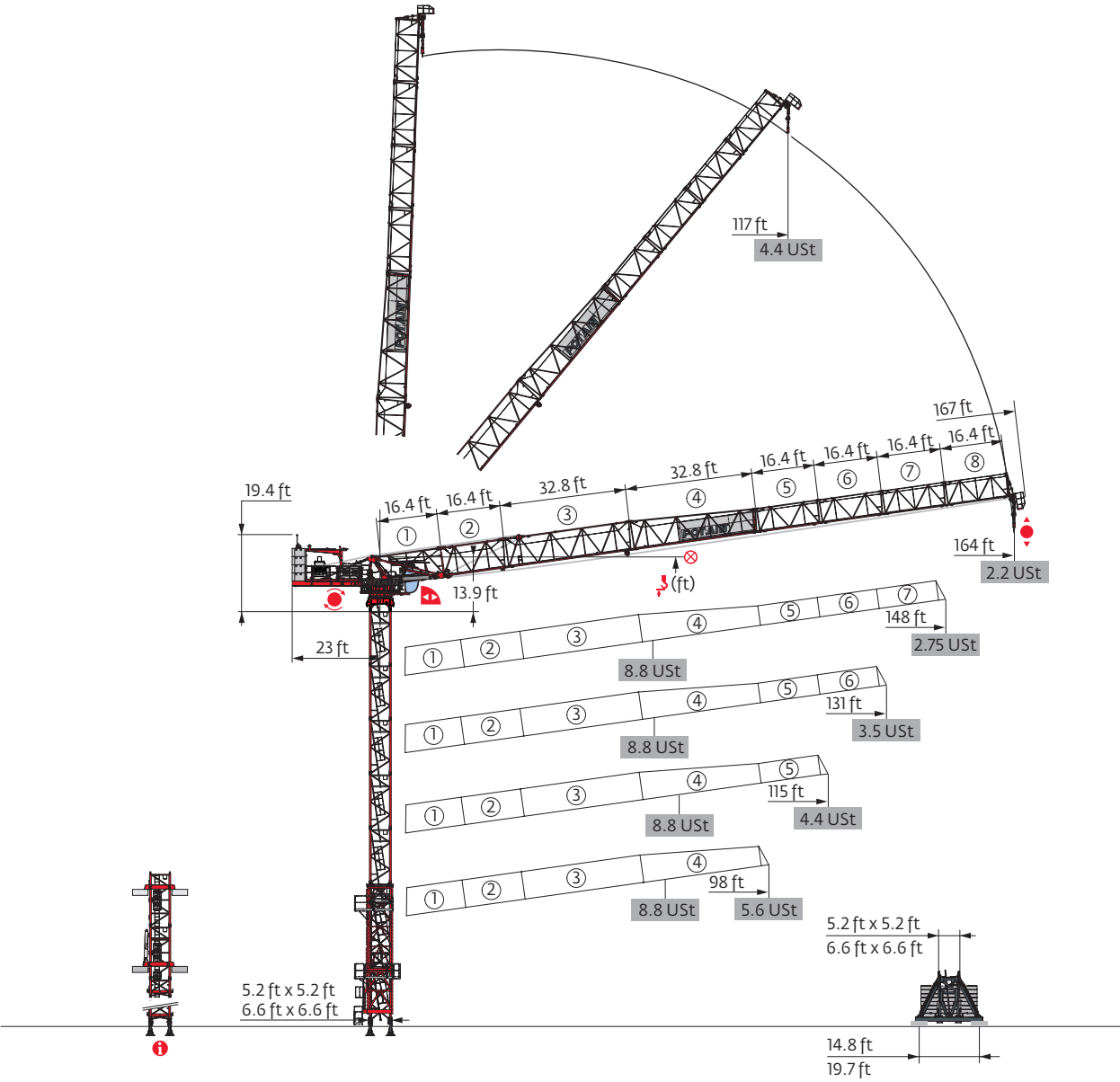

Mast - Reactions

5.2 ft - P 42A					
WIND (ft)	98	115	131	148	164
Height (ft)	162.4	151.6	146	135.2	129.6
10.9 ft	0	2	0	2	0
16.4 ft	7	5	6	4	5
32.8 ft	1	1	1	1	1
F2 (Ust)	● 156	154	153	151	150
	■ 240	237	239	234	236
F3 (Ust)	● 119	118	118	116	116
	■ 203	200	203	198	201

5.2 ft - S 41A					
WIND (ft)	98	115	131	148	164
Height (ft)	145.7	140.1	129.3	118.1	112.9
10.9 ft	2	0	2	1	2
16.4 ft	6	7	5	5	4
F1 (Ust)	● 90	92	91	89	89
	■ 107	110	107	102	105

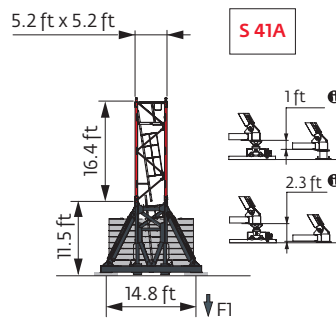
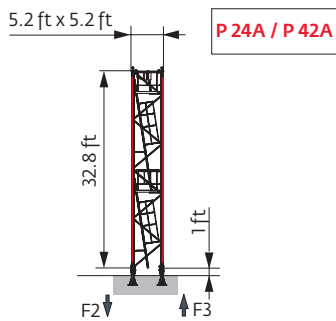

i Other mast compositions - Please consult us.

Motorized accesses: adapted mast compositions, base ballast and reactions.

Note: When "ASCE" is noted in this data sheet it is referring to 115 mph Wind Zone, Exposure B, Design Wind Speed = 98 mph. See back cover for design wind speed calculations.

6.6 ft - P 63A					
Span (ft)	98	115	131	148	164
h (ft)	228	222.8	217.2	211.6	206.4
10.9 ft	0	1	2	0	1
16.4 ft	11	10	9	10	9
32.8 ft	1	1	1	1	1
F2 (Ust)	● 175	175	175	175	174
	■ 393	398	401	402	404
F3 (Ust)	● 127	127	127	123	126
	■ 345	349	353	354	357

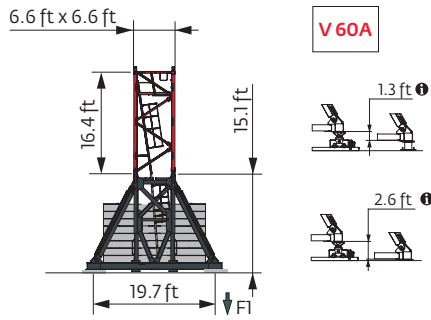
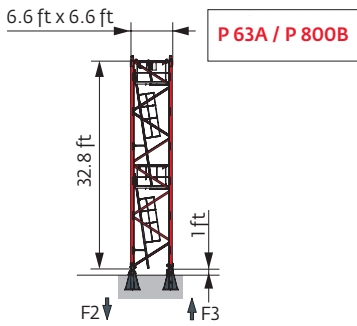

6.6 ft - V 60A					
Span (ft)	98	115	131	148	164
h (ft)	182.1	171.3	165.7	154.9	149.3
10.9 ft	2	1	2	1	2
16.4 ft	8	8	7	7	6
F1 (Ust)	● 97	96	96	95	93
	■ 137	131	133	126	128





Anchorage



Base ballast

 (USt) / 5.2 ft - S 41A - 





ft	98	115	131	148	164
145.7	119.1				
140.1	105.8	125.7			
129.3	86	105.8	125.7		
118.1	79.4	86	105.8	119.1	
112.9	79.4	86	92.6	112.4	125.7
96.5	72.8	72.8	79.4	86	92.6
80.1	59.5	66.1	72.8	72.8	79.4
63.7	52.9	59.5	59.5	66.1	72.8
47.3	46.3	52.9	52.9	59.5	59.5

 (USt) / 6.6 ft - V 60A - 

ft	98	115	131	148	164
182.1	145.5				
171.3	132.3	145.5			
165.7	119.1	132.3	145.5		
154.9	92.6	119.1	132.3	145.5	
149.3	92.6	105.8	119.1	132.3	145.5
132.9	66.1	79.4	92.6	105.8	119.1
116.5	39.7	52.9	66.1	79.4	92.6
100.1	39.7	39.7	39.7	52.9	66.1
83.7	26.5	39.7	39.7	39.7	39.7
67.3	26.5	26.5	26.5	39.7	39.7
50.9	26.5	26.5	26.5	26.5	26.5

Load curves



ft	56	66	72	82	89	98	98.9	105	115	115.2	121	131	131.4	138	148	ft			
 8.8 USt																			
 4.4 USt																			
																			
																			
148	14.1 → 70.8	109.5 - 111.7		8.8	8.8	8.6	7.1	6.3	5.3	-	4.8	4.2	-	3.8	3.2	-	2.9	2.5	USt
131	13.5 → 70.7	109.7 - 111.9		8.8	8.8	8.6	7.1	6.3	5.3	-	4.8	4.2	-	3.8	3.3	3.3	USt		
115	12.5 → 73.9			8.8	8.8	8.8	7.6	6.8	5.7	-	5.2	4.4	4.4	USt					
98	11.5 → 72.2			8.8	8.8	8.8	7.3	6.5	5.6	5.5	USt								

 =  - 0.16 USt max.



ft	56	66	72	82	89	98	98.9	105	115	115.2	121	131	131.4	138	148	154	164	ft	
 4.4 USt																			
164	15.1 → 117		4.4	4.4	4.4	4.4	4.4	4.4	4.4	4.4	4.4	4.1	3.6	-	3.2	2.8	2.55	2.2	USt
148	14.1 → 115.7		4.4	4.4	4.4	4.4	4.4	4.4	4.4	4.4	4.4	4	3.5	-	3.2	2.75	USt		
131	13.5 → 116		4.4	4.4	4.4	4.4	4.4	4.4	4.4	4.4	4.4	4.1	3.5	3.5	USt				
115	12.5 → 115.2		4.4	4.4	4.4	4.4	4.4	4.4	4.4	4.4	4.4	USt							
98	11.5 → 98.9		4.4	4.4	4.4	4.4	4.4	4.4	4.4	USt									

Jib weight & counter-jib ballast

Height (ft)	Jib Weight (lb) (+/- 5%)		Counter-jib Ballast (lb)	Total Weight (lb)
	②	⑧		
164 ft	12,887	-	4	41,888
148 ft	12,215	12,612	4	41,888
131 ft	11,432	11,829	4	41,888
115 ft	10,561	10,958	4	41,888
98 ft	9,514	9,911	4	41,888

CCL - 10,472 lb

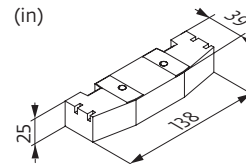



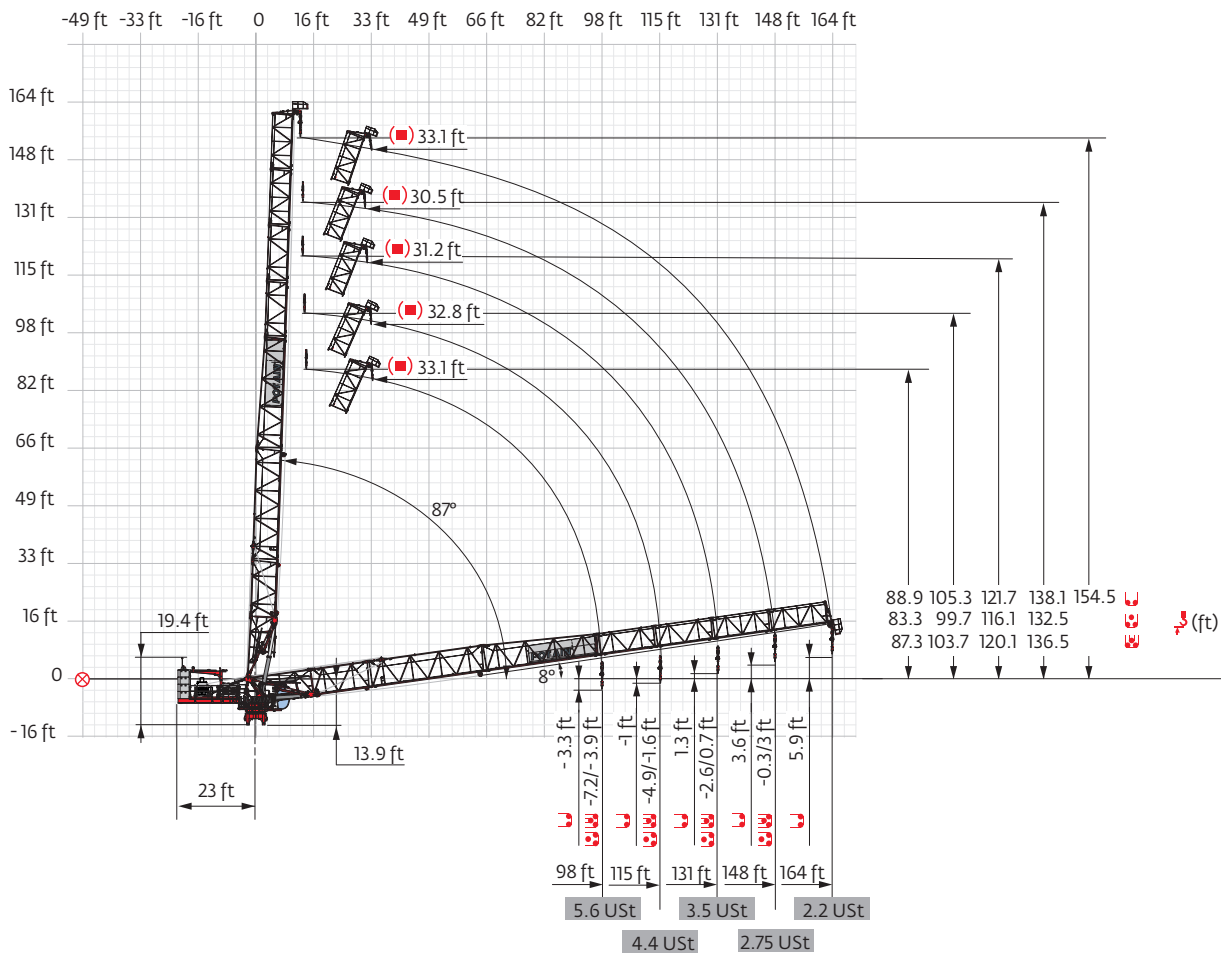





Luffing jib

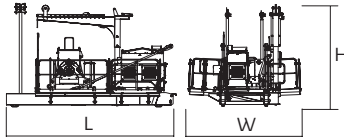
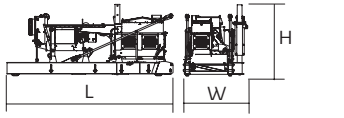
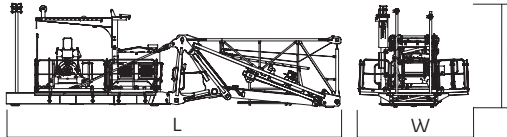
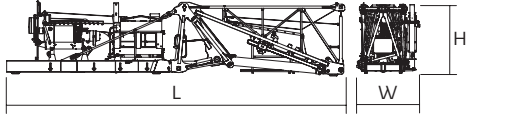
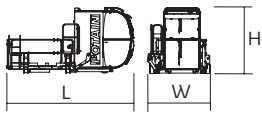
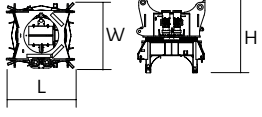

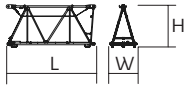
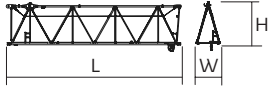

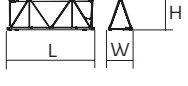





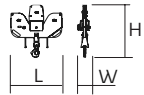

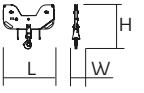
Dimensions and weight

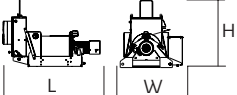
Slewing crane part:  164 ft -  33 LVF

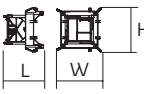

Slewing crane part		L (ft)	W (ft)	H (ft)	lb (+/- 5%)	
Counter-jib		33 LVF 50 LVF	19.3	12.9	11.6	12,721 13,735
		33 LVF 50 LVF	19	7.4	8.2	11,707 12,721
Counter-jib + Jib foot		33 LVF 50 LVF	38.9	12.9	11.6	25,728 26,742
		33 LVF 50 LVF	38.9	7.4	8.4	24,714 25,728
Cab		V140 SR	15.9	7.8	8.2	3,748
Towerhead		□ 5.2 ft □ 6.6 ft	7.1 7.6	6.8 7.8	7.7 7.7	10,362 12,710
Jib section		①	20.5	6.8	8.4	13,007
		②	17.2	5.2	8.3	2,172
		③	33.6	4.7	8.2	3,208
		④	33.5	4.7	7.8	3,296
		⑤	17	4.7	6.4	1,047
		⑥	16.9	4.6	6.3	871
		⑦	16.9	4.5	6.3	783
		⑧	16.9	4.5	6.3	672
			4	4.9	10	397

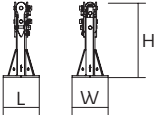
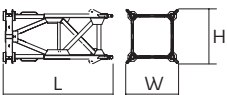
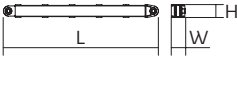
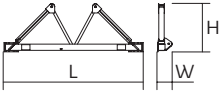
Pulley block			4.8	1.2	4.9	838
			4.8	0.7	4.1	441
Hoisting winch (+ rope)		33 LVF 50 LVF	7.7 8.2	5 5	5.3 5.3	3,428 4,442
Crane tower			L (ft)	W (ft)	H (ft)	lb (+/- 5%)
T41 T61		□ 5.2 ft □ 6.6 ft	35.6 35.5	12.3 13.6	13.5 14.7	15,653 21,385
K60/K40-2		□ 6.6/5.2 ft	7.3	8.2	8.1	5,820
K 447E KM 447E KM 449E K 649B KM 649E KRM 6410B		□ 5.2 ft □ 5.2 ft □ 5.2 ft □ 6.6 ft □ 6.6 ft □ 6.6 ft	33.5 33.5 33.5 33.6 33.8 33.6	5.3 5.3 5.3 6.8 6.7 6.9	5.3 5.3 5.3 6.7 6.7 6.8	7,474 7,088 8,830 11,663 10,692 15,653
K 447A KMT 447A K 449A KMT 449A KR 649A KRMT 649A K 649A KMT 649A		□ 5.2 ft □ 5.2 ft □ 5.2 ft □ 5.2 ft □ 6.6 ft □ 6.6 ft □ 6.6 ft □ 6.6 ft	17.1 17.1 17.1 17.1 17.2 17.2 17.2 17.2	5.5 5.5 5.5 5.5 6.9 6.9 6.8 6.8	5.3 5.3 5.3 5.3 6.8 6.8 6.7 6.7	4,079 3,847 4,916 4,696 7,165 6,724 6,184 5,666
K 447C KMT 447C K 649C KMT 649C KRMT 649C		□ 5.2 ft □ 5.2 ft □ 6.6 ft □ 6.6 ft □ 6.6 ft	11.3 11.6 11.7 11.7 11.7	5.5 5.5 6.8 6.8 6.9	5.3 5.3 6.7 6.7 6.8	2,998 2,976 4,376 4,542 5,401
Fixing angles		P 24A / P 42A P 63A / P 800B	1.8 2.5	1.8 2.5	3.8 4.2	529 1,025
Basic mast unit		S 41A V 60A	11.9 16.4	6.4 7.9	6.8 7.9	7,132 10,494
Struts		S 41A V 60A	10.4 14.8	0.9 1	0.8 1	816 1,036
Half-bearer		S 41A V 60A	16.7 22	2 2.3	5.8 7.6	2,315 4,057

Mechanisms

480 V - 60 Hz										hp	kW		
	33 LVF 20 Optima	fpm	85	112	164	233	43	56	82	116	33	22	1,539 ft
	USt	4.4	3.3	2.2	1.1	8.8	6.6	4.4	2.2				
	50 LVF 20 Optima	fpm	144	190	269	387	72	95	135	194	50	37	2,287 ft
	USt	4.4	3.3	2.2	1.1	8.8	6.6	4.4	2.2				
	40 VVH 80	min	2							40	30		
	RVF 152 Optima +	rpm	0 → 0.8							2 x 5.5	2 x 4		

33 LVF 20 Optima

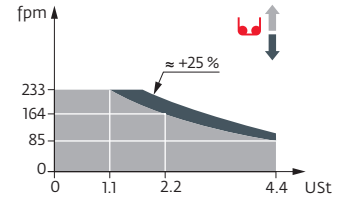

50 LVF 20 Optima

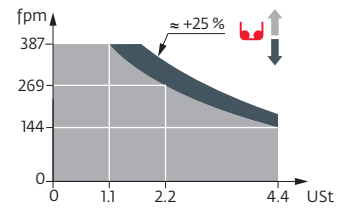

IEC 60204-32	kVA
480 V (+6% -10%) 60 Hz	33 LVF: 74 → 61 kVA 50 LVF: 88 kVA

These most combinations meet the EN 14439 and ASME B30.3-2016 specifications for "out of service" wind conditions, provided the illustrated wind speed matches required design wind speed for the location of the tower crane. The "out of service" design wind speed was determined in accordance with ASCE 7-10, Figure 26.5-1A. The wind velocity, used for this configuration was 98 mph (158 kph), which represents a nominal design 3-second wind gust at 33 ft (10 m) above ground for Exposure B category. A factor of 0.85 was applied to the 700-year ultimate design wind speed of 115 mph (185 kph), per ASCE 37-02, with the assumption that this crane is considered a temporary structure used during a construction period of 2 years or less.

- Standard equipment
- Options
- Weathering position
- Lorry 44 ft
- Reactions in service
- Reactions out of service
- Container High Cube 40 ft, and/or Flat Rack 20 ft
- Hoisting
- Luffing
- Jib weight
- Total ballast weight
- Slewing
- Jib articulation axis
- Travelling
- Required power
- Power Control Function: winch speeds adapted to the available power
- Consult us

This commercial document is not legally binding. For any technical information, please refer to the corresponding instructions.

