

MDT 809 M32

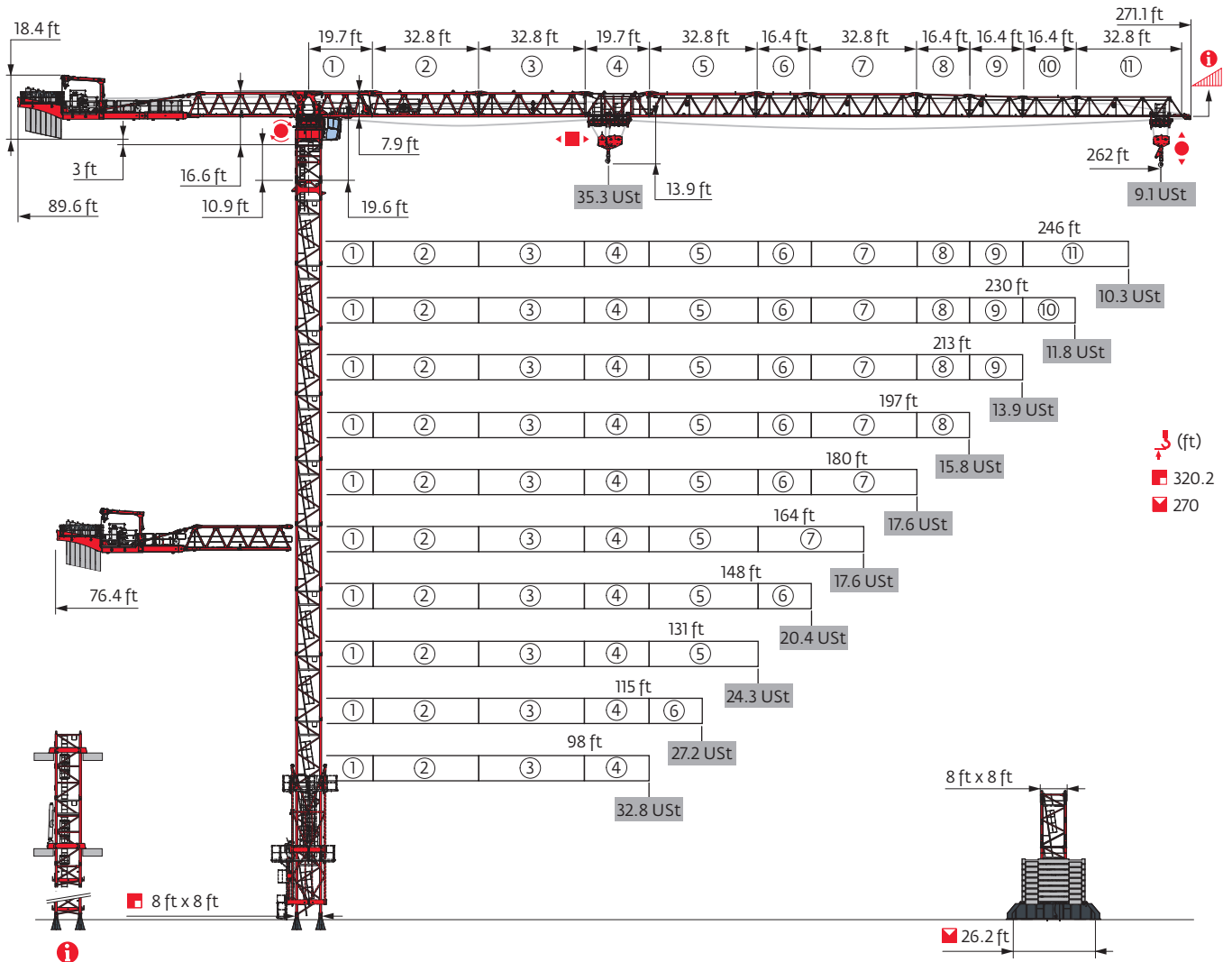

Potain Plus



Power Control

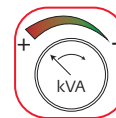

Top Site



Top Tracing 3

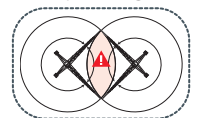

Mast - Reactions

8 ft - P 854A											
Height (ft)	98	115	131	148	164	180	197	213	230	246	262
↓ (ft)	270.3	259.2	264.8	264.8	275.6	270.3	264.8	264.8	259.2	259.2	253.9
↓/P _r (ft)	253.9	248.4	248.4	242.8	264.8	242.8	248.4	242.8	259.2	259.2	253.9
10.9 ft	1	1	1	1	1	1	1	1	1	1	1
6.2 ft	1	1	1	1	1	1	1	1	1	1	1
10.9 ft	1	0	2	2	0	1	2	2	0	0	1
16.4 ft	15	15	14	14	16	15	14	14	15	15	14
F2 (Ust)	● 411	404	410	409	406	412	401	409	413	401	397
	■ 543	489	524	533	569	553	539	547	525	532	522
F3 (Ust)	● 273	267	266	262	254	262	251	257	260	248	244
	■ 423	370	397	402	435	420	407	412	389	397	387

8 ft - P 880A											
Height (ft)	98	115	131	148	164	180	197	213	230	246	262
↓ (ft)	320.2	309.1	309.1	309.1	320.2	314.6	314.6	309.1	309.1	303.8	298.2
↓/P _r (ft)	309.1	292.7	292.7	292.7	309.1	292.7	292.7	287.4	303.8	303.8	298.2
10.9 ft	1	1	1	1	1	1	1	1	1	1	1
6.2 ft	1	1	1	1	1	1	1	1	1	1	1
10.9 ft	1	0	0	0	1	2	2	0	0	1	2
16.4 ft	18	18	18	18	18	17	17	18	18	17	16
F2 (Ust)	● 488	491	483	486	478	494	484	485	470	475	477
	■ 855	778	757	779	853	869	854	793	775	762	745
F3 (Ust)	● 320	322	312	311	301	315	305	305	296	297	300
	■ 706	627	604	622	694	708	692	631	619	602	586

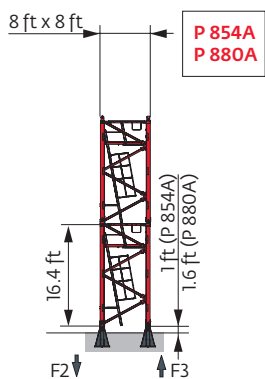

Note: When "ASCE" is noted in this data sheet it is referring to 115 mph Wind Zone, Exposure B, Design Wind Speed = 98 mph. See back cover for design wind speed calculations.

Motorized accesses: adapted mast compositions, base ballast and reactions.

Other mast compositions - Please consult us

8 ft - ZY 854 -

WxH (ft)	98	115	131	148	164	180	197	213	230	246	262
\bar{r} (ft)	270	264.8	253.6	264.8	259.2	253.6	248.4	248.4	248.4	248.4	242.8
\bar{r}/P_r (ft)	215.6	237.2	193.6	199.2	253.6	193.6	188	193.6	226.4	232	232
	10.9 ft	1	1	1	1	1	1	1	1	1	1
	6.2 ft	1	1	1	1	1	1	1	1	1	1
	10.9 ft	2	0	2	0	1	2	0	0	0	1
	16.4 ft	14	15	13	15	14	13	14	14	14	13
F1 (Ust)	● 246	243	234	243	231	235	232	237	236	233	238
	■ 269	247	226	255	243	233	221	227	233	239	239

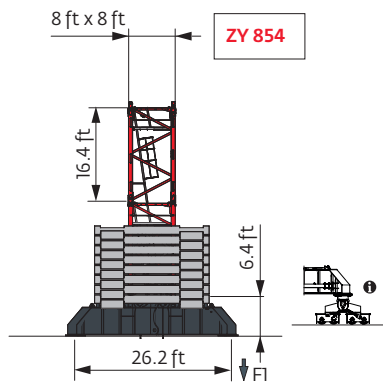

Anchorage



Base ballast

⚖️ (Ust) / 8 ft - ZY 854 - ⚖️

⚖️ (ft)	98	115	131	148	164	180	197	213	230	246	262
270	158.7										
264.8	158.7	158.7		145.5							
259.2	145.5	145.5		132.3	119.1						
253.6	145.5	145.5	145.5	132.3	132.3	158.7					
248.4	145.5	145.5	132.3	132.3	132.3	158.7	158.7	172	172	172	
242.8	145.5	145.5	132.3	132.3	132.3	158.7	158.7	172	172	172	198.4
226.4	132.3	145.5	119.1	119.1	119.1	145.5	158.7	158.7	158.7	172	185.2
210	132.3	132.3	105.8	92.6	92.6	145.5	158.7	158.7	158.7	158.7	185.2
193.6	119.1	105.8	105.8	105.8	92.6	145.5	145.5	145.5	158.7	158.7	172
177.2	105.8	92.6	92.6	92.6	92.6	132.3	145.5	145.5	145.5	158.7	172
160.8	92.6	92.6	79.4	79.4	92.6	132.3	132.3	145.5	145.5	158.7	158.7
144.4	92.6	92.6	79.4	79.4	79.4	132.3	132.3	132.3	145.5	158.7	158.7
128	92.6	92.6	79.4	79.4	79.4	119.1	132.3	132.3	145.5	158.7	158.7
111.6	92.6	92.6	79.4	79.4	79.4	119.1	119.1	119.1	145.5	158.7	158.7
95.1	92.6	92.6	79.4	79.4	79.4	119.1	119.1	119.1	145.5	158.7	158.7
78.7	92.6	92.6	79.4	79.4	79.4	105.8	105.8	119.1	145.5	158.7	158.7
62.3	92.6	92.6	79.4	79.4	79.4	105.8	105.8	119.1	145.5	158.7	158.7

Counter-jib ballast

⚖️ (ft)	180 HPL™			320 LVF GH		
	14,551 lb	10,362 lb	⚖️ (lb)	14,551 lb	10,362 lb	⚖️ (lb)
262 ft	7	0	101,854	5	2	93,476
246 ft	6	1	97,665	4	3	89,287
230 ft	5	2	93,476	6	0	87,303
213 ft	4	3	89,287	5	1	83,114
197 ft	6	0	87,303	4	2	78,925
180 ft	4	2	78,925	5	0	72,753
164 ft	6	1	97,665	4	3	89,287
148 ft	4	3	89,287	5	1	83,114
131 ft	5	1	83,114	3	3	74,737
115 ft	4	1	68,564	3	2	64,375
98 ft	3	2	64,375	3	1	54,013

CCP - 14,551 lb

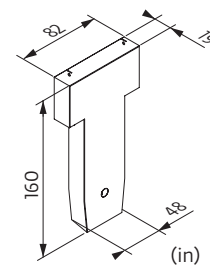

CCQ - 10,362 lb

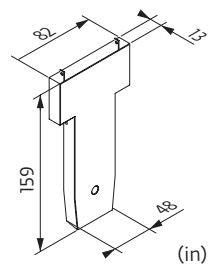

Load curves



▽▽▽▽▽ (ft)		72	82	98	105	115	121	131	138	148	154	164	171	180	187	197	203	213	220	230	236	246	253	262	ft	
	↔ 35.3 USt	↔ 17.6 USt																								
262	13.8 → 73.8	129.7 - 142.4	35.3	31.1	24.9	23	20.6	19.2	17.6	17.6	16.9	16.1	14.9	14.2	13.3	12.7	11.9	11.5	10.8	10.4	9.8	9.5	9	8.7	8.3	USt
	13.8 → 79.1	139.3 - 153	35.3	33.8	27.2	25.1	22.5	21	19	17.9	17.6	17.5	16.2	15.5	14.5	13.9	13.1	12.5	11.8	11.4	10.8	10.4	9.9	9.6	9.1	USt P+
246	13.8 → 75.5	133.5 - 146.1	35.3	32	25.7	23.8	21.3	19.9	18	17.6	17.4	16.6	15.4	14.7	13.7	13.2	12.4	11.9	11.2	10.8	10.2	9.9	9.4		USt	
	13.8 → 81.4	143.7 - 157.5	35.3	34.9	28.1	26	23.4	21.8	19.8	18.6	17.6	17.6	16.8	16.1	15	14.4	13.5	13	12.3	11.9	11.2	10.8	10.3		USt P+	
230	13.8 → 78.4	138.9 - 151.6	35.3	33.4	26.9	24.9	22.3	20.9	18.9	17.8	17.6	17.3	16.1	15.4	14.4	13.8	13	12.5	11.8	11.3	10.7				USt	
	13.8 → 84.3	149.7 - 164	35.3	35.3	29.5	27.3	24.5	22.9	20.8	19.6	17.9	17.6	17.6	16.8	15.8	15.1	14.2	13.7	12.9	12.5	11.8				USt P+	
213	13.8 → 83	147.6 - 161.1	35.3	35.3	28.9	26.8	24.1	22.5	20.4	19.2	17.6	17.6	17.3	16.5	15.5	14.8	13.9	13.4	12.7						USt	
	13.8 → 89.9	159.1 - 174.4	35.3	35.3	31.7	29.4	26.4	24.7	22.5	21.2	19.4	18.4	17.6	17.6	17	16.3	15.3	14.7	13.9						USt P+	
197	13.8 → 85	151 - 164.8	35.3	35.3	29.7	27.5	24.7	23.1	21	19.8	18.1	17.6	17.6	16.9	15.9	15.2	14.3									USt
	13.8 → 91.9	162.7 - 178.7	35.3	35.3	32.6	30.2	27.2	25.4	23.1	21.8	20	18.9	17.6	17.6	17.4	16.7	15.8									USt P+
180	13.8 → 85.3	151.9 - 165.8	35.3	35.3	29.9	27.7	24.9	23.3	21.2	19.9	18.3	17.6	17.6	17.1	16											USt
	13.8 → 91.5	163.7 - 180.4	35.3	35.3	32.4	30.1	27.1	25.4	23.2	21.9	20.1	19	17.6	17.6	17.6											USt P+
164	13.8 → 84.6	150.3 - 164	35.3	35.3	29.5	27.4	24.6	23	20.9	19.7	18	17.6	17.6													USt
	13.8 → 88.6		35.3	35.3	31.3	29	26	24.4	22.2	20.9	19.2	18.2	17.6													USt P+
148	13.8 → 86.3		35.3	35.3	30.3	28.1	25.2	23.6	21.4	20.2	18.5															USt
	13.8 → 91.5		35.3	35.3	32.5	30.2	27.3	25.6	23.4	22.1	20.4															USt P+
131	13.8 → 89.9		35.3	35.3	31.7	29.4	26.4	24.7	22.5																	USt
	13.8 → 94.2		35.3	35.3	33.6	31.3	28.3	26.5	24.3																	USt P+
115	13.8 → 88.3		35.3	35.3	31.1	28.8	25.9																			USt
	13.8 → 91.2		35.3	35.3	32.4	30.1	27.2																			USt P+
98	13.8 → 87.9		35.3	35.3	30.9																					USt
	13.8 → 92.2		35.3	35.3	32.8																					USt P+

$$USt = USt - 2.24 USt \text{ max.}$$















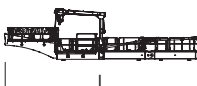
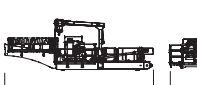
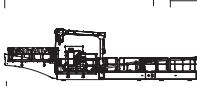
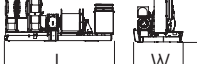
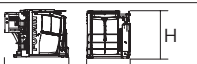

▽▽▽▽▽ (m)		72	82	98	105	115	121	131	138	148	154	164	171	180	187	197	203	213	220	230	236	246	253	262	ft	
	↔ 35.3 USt	↔ 17.6 USt																								
262	11.2 → 73.5	128.4 - 131.6	35.3	30.9	24.7	22.8	20.4	19	17.6	16.6	15.2	14.3	13.2	12.5	11.6	11	10.2	9.8	9.1	8.7	8.1	7.8	7.3	7	6.6	USt
	11.2 → 78.7	137.9 - 141.3	35.3	33.6	27	24.9	22.3	20.8	18.8	17.7	16.7	15.8	14.5	13.8	12.8	12.2	11.3	10.8	10.1	9.7	9.1	8.7	8.2	7.8	7.4	USt P+
246	11.2 → 75.1	132 - 135.4	35.3	31.8	25.5	23.6	21.1	19.6	17.8	17.2	15.8	14.9	13.8	13.1	12.1	11.5	10.7	10.3	9.6	9.2	8.6	8.2	7.7		USt	
	11.2 → 80.7	142.2 - 145.9	35.3	34.7	27.9	25.8	23.1	21.6	19.6	18.4	17.4	16.5	15.2	14.4	13.4	12.8	11.9	11.4	10.7	10.2	9.6	9.2	8.7		USt P+	
230	11.2 → 77.4	136.2 - 139.7	35.3	33	26.5	24.5	21.9	20.4	18.5	17.6	16.4	15.5	14.3	13.6	12.6	12	11.2	10.7	10	9.6	9				USt	
	11.2 → 83.7	146.8 - 150.9	35.3	35.3	29	26.9	24.1	22.5	20.4	19.2	17.6	16.5	15.9	15.1	14	13.4	12.5	11.9	11.2	10.7	10.1				USt P+	
213	11.2 → 82.7	146.2 - 149.9	35.3	35.3	28.7	26.6	23.8	22.3	20.2	19	17.6	17	15.8	15	13.9	13.3	12.4	11.9	11.2						USt	
	11.2 → 89.2	157.5 - 162.3	35.3	35.3	31.5	29.2	26.2	24.5	22.3	20.9	19.2	18.1	17.4	16.6	15.4	14.7	13.8	13.2	12.4						USt P+	
197	11.2 → 84.6	149.5 - 153.4	35.3	35.3	29.5	27.3	24.5	22.9	20.8	19.6	17.9	17.5	16.2	15.4	14.4	13.7	12.8								USt	
	11.2 → 91.5	161.2 - 166.3	35.3	35.3	32.4	30	27	25.2	22.9	21.5	19.7	18.7	17.6	17.1	15.9	15.2	14.2								USt P+	
180	11.2 → 85.3	151.9 - 155.8	35.3	35.3	29.9	27.7	24.9	23.3	21.2	19.9	18.3	17.6	16.6	15.8	14.7										USt	
	11.2 → 91.5	163.7 - 169.1	35.3	35.3	32.4	30.1	27.1	25.4	23.2	21.9	20.1	19	17.6	17.5	16.3										USt P+	
164	11.2 → 86.9	154.4 - 158.4	35.3	35.3	30.5	28.2	25.4	23.7	21.6	20.3	18.7	17.7	16.9												USt	
	11.2 → 88.6	157.8 - 164	35.3	35.3	31.3	29	26	24.4	22.2	20.9	19.2	18.2	17.6												USt P+	
148	11.2 → 86.3		35.3	35.3	30.3	28.1	25.2	23.6	21.4	20.2	18.5														USt	
	11.2 → 91.5		35.3	35.3	32.5	30.2	27.3	25.6	23.4	22.1	20.4														USt P+	
131	11.2 → 89.9		35.3	35.3	31.7	29.4	26.4	24.7	22.5																USt	
	11.2 → 94.2		35.3	35.3	33.6	31.3	28.3	26.5	24.3																USt P+	
115	11.2 → 88.3		35.3	35.3	31.1	28.8	25.9																		USt	
	11.2 → 91.2		35.3	35.3	32.4	30.1	27.2																		USt P+	
98	11.2 → 87.9		35.3	35.3	30.9																				USt	
	11.2 → 92.2		35.3	35.3	32.8																				USt P+	





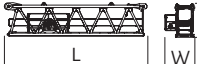

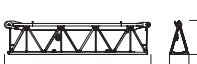



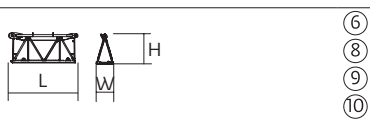
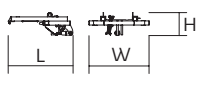
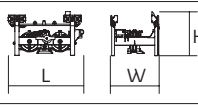

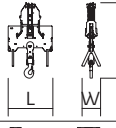

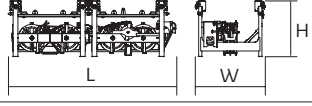



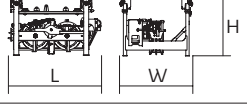

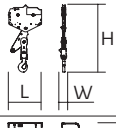
$$USt = USt - 0.85 USt \text{ max.}$$

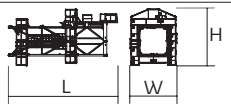
Dimensions and weight

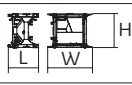
Slewing crane part:  262 ft -  -  -  180 HPL™

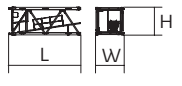

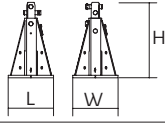
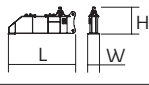
Slewing crane part		L (ft)	W (ft)	H (ft)	lb (+/- 5%)
Counter-jib		25.9	7.4	7.4	23,171
		39.4	7.4	7.4	31,978
		34	4.5	8.1	21,142
	 180 HPL™ 320 LVF GH	39.7	21.9	13.7	27,040
	 180 HPL™ 320 LVF GH	52.8	21.9	13.7	35,891
	 180 HPL™	39.7	21.9	13.7	43,738
	 180 HPL™	52.8	21.9	13.7	52,589
Hoisting winch (+ rope)	 180 HPL™ 320 LVF GH	15.8 18.4	6.3 7.2	6.5 7.8	16,698 31,150
					
Cab	 Ultra View	11	7.5	8.2	6,614
Towerhead	 8 ft	8.5	8.2	9.7	34,392
		22.5	8.2	9.7	41,006
					
Jib section	 ①	25.6	5.1	8.2	27,893
	 ② ③	34.5 34.1	7.3 4.8	8.2 8.1	27,133 18,683
	 ④	20.9	4.5	7.9	8,754
	 ⑤ ⑦ ⑪	34.4 33.9 33.2	4.5 4.5 4.5	7.8 7.5 6.4	10,983 7,043 3,103
					
					

			L (ft)	W (ft)	H (ft)	lb (+/- 5%)
Jib section		⑥	17.8	4.5	7.7	4,859
		⑧	17.3	4.5	7.3	3,013
		⑨	17.3	4.5	6.8	2,175
		⑩	17.3	4.5	6.7	1,955
			5.5	5.2	1.9	728
Trolley		 35.3 USt	8.6	5.7	5.2	2,678
Pulley block		 35.3 USt	6.2	2.6	10.4	3,120
Trolley		 35.3 USt	13.8	5.9	4.9	3,219
Pulley block		 35.3 USt	7.5	1.1	9.7	2,888
Trolley		 17.6 USt	6.9	5.9	4.9	1,720
Pulley block		 17.6 USt	5	1.1	10	1,786
Trolley inspection platform			3.1	3.4	7	125
Crane tower						
T 851		 8 ft	36.7	15.9	19	34,723
K 85/K 85-2		 8 ft	7.3	10.7	8.2	7,937
KM 850.10B KM 850.14B KMT 850.10A KMT 850.14A K 88/K 85A2 KM 880.10A KMT 850.10C		 8 ft	33.9 33.9 17.5 17.5 17.5 17.8 12	8.3 8.3 8.3 8.3 8.2 8.3 8.3	8.2 8.2 8.2 8.2 8.2 8.3 8.2	22,201 24,670 12,015 13,206 18,281 18,453 9,326
Fixing angles		P 854A P 880A	3 3.3	3 3.3	4.9 6.2	2,072 3,536
1/2 Cross girder		ZY 854	18.7	3.2	7.4	14,176
Cross girder		ZY 854	39	4.7	7.4	30,865

Mechanisms

480 V - 60 Hz													hp	kW	
	180 HPL™ 80	fpm	139	172	230	358	495	71	87	115	184	248	180	132	1,660 ft
		USt	17.6	13.2	8.8	4.4	2	35.3	26.5	17.6	8.8	5.2			
	320 LVF 80 GH Optima	fpm	277	351	474	663	705	138	176	243	353	320	240	3,488 ft	
		USt	17.6	13.2	8.8	4.4	3.6	35.3	26.5	17.6	9.4				
	15 DVF 16 Optima	fpm	0 → 108 (35.3 USt) 0 → 164 (22 USt) 0 → 220 (11 USt) 0 → 328 (2.8 USt)									15	11		
	RVF 174 Optima +	rpm	0 → 0.7									4 x 10	4 x 7.5		

480 V (+6% -10%) 60 Hz	180 HPL™: 194 → 122 kVA	
	320 LVF GH: 306 → 178 kVA	

These mast combinations meet the EN 14439 and ASME B30.3-2016 specifications for "out of service" wind conditions, provided the illustrated wind speed matches required design wind speed for the location of the tower crane. The "out of service" design wind speed was determined in accordance with ASCE 7-10, Figure 26.5-1A. The wind velocity, used for this configuration was 98 mph (158 kph), which represents a nominal design 3-second wind gust at 33 ft (10 m) above ground for Exposure B category. A factor of 0.85 was applied to the 700-year ultimate design wind speed of 115 mph (185 kph), per ASCE 37-02, with the assumption that this crane is considered a temporary structure used during a construction period of 2 years or less.

- Jib elevation
- Total ballast weight
- Required power
- Standard equipment
- Lorry 44 ft
- Power Control Function: winch speeds adapted to the available power
- Options
- Container High Cube 40 ft, and/or Flat Rack 20 ft
- Consult us
- Potain Plus function: Plus load curves
- Hoisting
- Hook heights with Plus load curves
- Trolleying
- Reactions in service
- Slewing
- Reactions out of service
- Travelling

This commercial document is not legally binding. For any technical information, please refer to the corresponding instructions.

