

MDT 569 M32

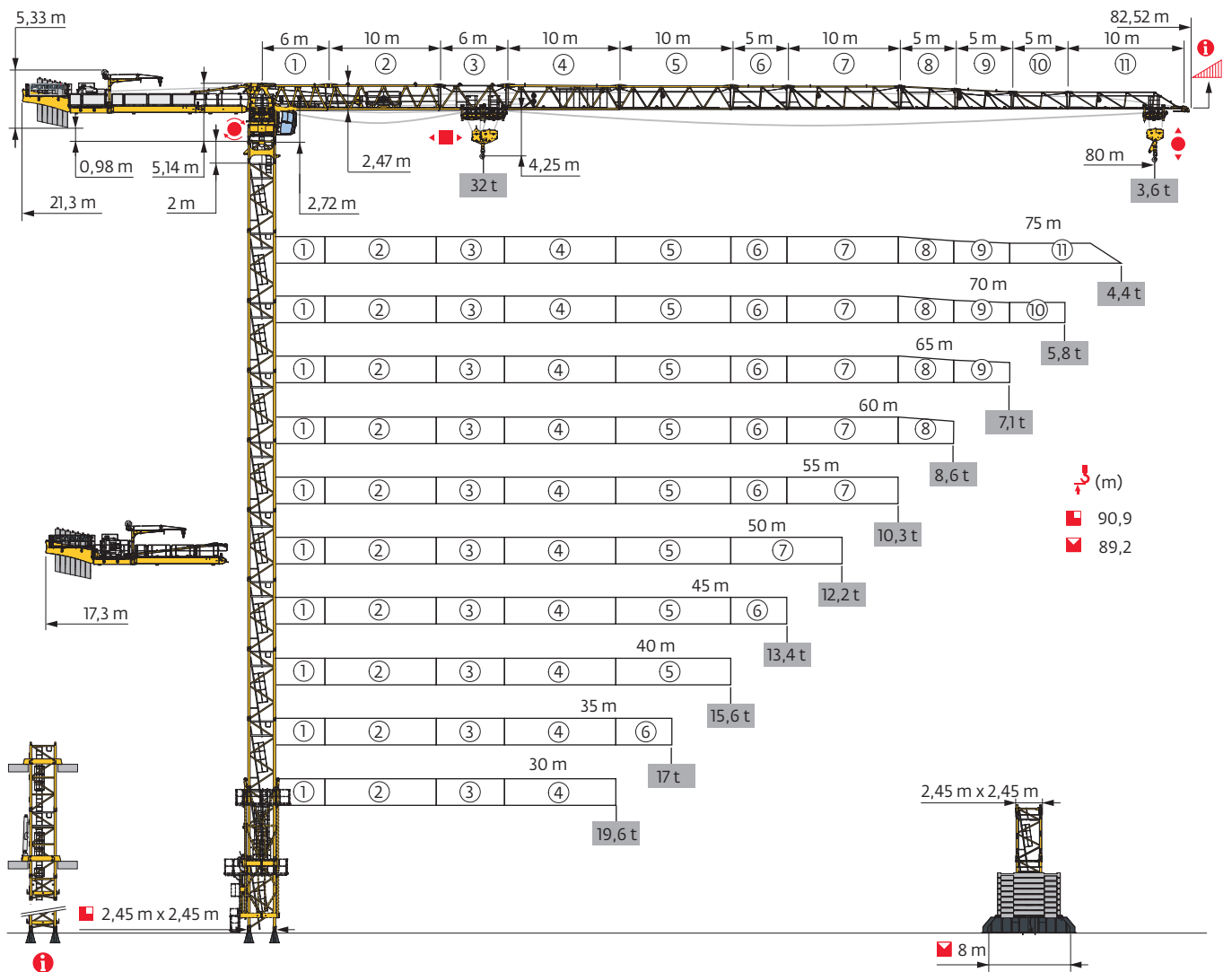

Potain Plus



Power Control

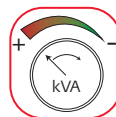

Top Site



Top Tracing 3

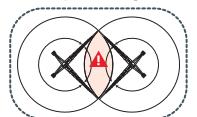

Mât - Réactions / Mast - Reaktionskräfte / Mast - Reactions / Mástil - Reacciones / Torre - Reazioni
Tramo - Reacções / Реакция опор мачты

□ 2,45 m - P 800B												
ΔΔΔΔΔ (m)	30	35	40	45	50	55	60	65	70	75	80	
↓ (m)	72,6	72,6	72,6	70,9	70,9	70,9	72,6	74,2	72,6	72,6	70,9	
↓/P+ (m)	72,6	72,6	72,6	70,9	70,9	70,9	70,9	70,9	70,9	72,6	70,9	
	2 m	1	1	1	1	1	1	1	1	1	1	
	3,33 m	2	2	2	0	0	2	1	2	2	0	
	5 m	13	13	13	14	14	14	13	14	13	14	
F2 (t)	●	271	271	271	271	267	270	269	269	264	266	269
	■	304	298	302	290	287	302	325	339	341	349	333
F3 (t)	●	176	173	170	169	163	169	167	166	162	163	166
	■	224	216	217	204	199	217	239	252	255	262	246

□ 2,45 m - P 854A												
ΔΔΔΔΔ (m)	30	35	40	45	50	55	60	65	70	75	80	
↓ (m)	89,2	90,9	90,9	87,6	89,2	89,2	89,2	89,2	87,6	85,9	85,9	
↓/P+ (m)	89,2	90,9	89,2	87,6	87,6	87,6	87,6	87,6	87,6	85,9	85,9	
	2 m	1	1	1	1	1	1	1	1	1	1	
	3,33 m	1	0	0	2	1	1	1	2	0	0	
	5 m	17	18	18	16	17	17	17	17	16	17	17
F2 (t)	●	331	337	335	333	330	333	334	329	332	317	329
	■	491	510	509	490	490	502	503	493	500	476	479
F3 (t)	●	221	222	218	216	210	218	218	215	217	206	217
	■	398	411	408	388	387	403	403	395	400	380	383

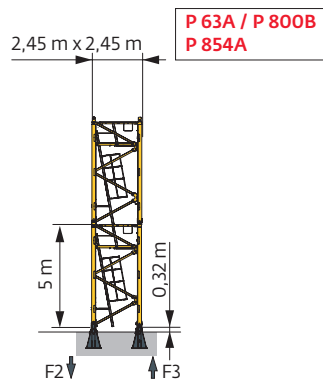

❗ Autres compositions de pylône - Nous consulter. / Andere Turmaufbauten - bitte kontaktieren Sie uns. / Other mast compositions - Please consult us. / Para otras composiciones de mástil - Por favor contáctenos. / Per altre composizioni torre, contattateci. / Para outras composições de coluna - Por favor, consulte-nos. / Для других композиций мачты пожалуйста консультируйтесь с нами.

Accès motorisés : compositions de mât, de lest de base et réactions adaptées. / Motorisierter Zugang vom : Mastzusammensetzung, Grundballast und Reaktionskräfte sind angepasst. / Motorized accesses: adapted mast composition, base ballast and reactions. / Acceso a cabina con elevador: Adaptación de composición de mástil, lastre de base y reacciones. / Accessi motorizzati: composizioni elementi torre, zavorre di base e reazioni aggiornate. / Acessos motorizados: composições de coluna, lastro da base e reacções adaptadas. / Лифты : адаптированная композиция мачты, базовый балласт и нагрузки.

2,45 m - ZY 800 - 

ΔΔΔΔ (m)	30	35	40	45	50	55	60	65	70	75	80
r_j (m)	65,6	67,3	68,9	67,3	68,9	72,3	72,3	73,9	72,3	70,6	70,6
r_j/P_r (m)	65,6	65,6	63,9	62,3	60,6	55,6	60,6	68,9	72,3	70,6	70,6
	2 m	1	1	1	1	1	1	1	1	1	1
	3,33 m	1	0	2	0	2	0	2	0	1	1
	5 m	12	13	12	13	12	14	14	13	14	13
Fl (t)	● 142	147	151	150	152	160	159	159	160	154	158
	■ 128	130	145	138	147	173	176	192	188	186	189

2,45 m - ZY 854 - 

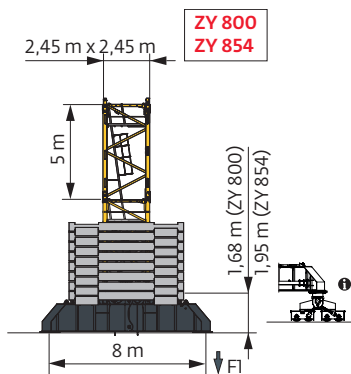

ΔΔΔΔ (m)	30	35	40	45	50	55	60	65	70	75	80
r_j (m)	87,5	89,2	89,2	87,5	87,5	87,5	87,5	87,5	85,9	84,2	84,2
r_j/P_r (m)	87,5	89,2	87,5	87,5	87,5	85,9	85,9	85,9	85,9	84,2	84,2
	2 m	1	1	1	1	1	1	1	1	1	1
	3,33 m	0	2	2	0	0	0	0	1	2	2
	5 m	17	16	16	17	17	17	17	16	15	15
Fl (t)	● 207	213	214	216	213	211	211	210	210	206	211
	■ 269	283	284	285	280	280	282	280	281	278	281



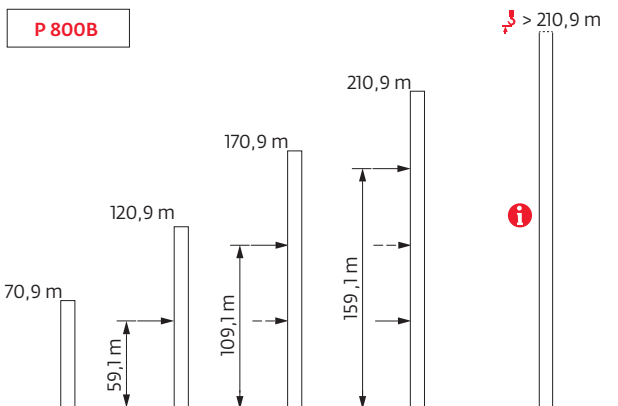

Ancrages / Verankerungen / Anchorages / Anclajes / Ancoraggi
 Ancoragem / нкера



Lest de base / Grundballast / Base ballast / Lastre de base / Zavorra di base
 Lastro da base / Базовый Балласт

 (t) /  2,45 m - ZY 800 - 

▲▼▲ (m)	30	35	40	45	50	55	60	65	70	75	80
73,9								96			
72,3						84	84	84	96		
70,6						72	72	72	84	96	96
68,9			72		72	72	60	72	84	84	96
67,3		84	72	60	60	60	60	72	84	84	96
65,6	72	72	60	60	60	60	60	72	84	84	96
60,6	60	60	60	48	48	48	48	72	84	84	84
55,6	48	60	48	48	48	48	48	60	84	84	84
50,6	48	48	48	36	36	48	48	60	72	84	84
45,6	36	48	36	36	36	48	48	60	72	72	84
40,6	36	36	36	36	36	48	48	60	72	72	72
35,6	36	36	36	36	36	36	48	60	72	72	72
30,6	36	36	36	36	36	36	48	60	60	60	60
25,6	36	36	36	36	36	36	48	60	60	60	60
20,6	36	36	36	36	36	36	48	60	60	60	60
15,6	36	36	36	36	36	36	48	60	60	60	60

 (t) /  2,45 m - ZY 854 - 

▲▼▲ (m)	30	35	40	45	50	55	60	65	70	75	80
89,2		192	192								
87,5	192	168	180	192	180	192	192	192			
85,9	168	156	156	168	156	180	192	180	192		
84,2	156	144	144	156	144	168	168	168	192	192	192
79,2	120	108	108	108	96	120	132	132	144	156	156
74,2	96	84	84	84	72	84	84	84	108	108	120
69,2	72	72	60	60	60	60	60	60	84	84	84
64,2	60	60	60	48	48	48	48	60	72	84	84
59,2	48	48	48	36	36	48	48	60	72	72	84
54,2	36	48	36	36	36	36	48	60	72	72	72
49,2	36	36	36	24	36	36	36	60	72	72	72
44,2	36	36	36	24	24	36	36	60	60	60	72
39,2	24	36	24	24	24	36	36	48	60	60	60
34,2	24	24	24	24	24	24	36	48	60	60	60
29,2	24	24	24	24	24	24	36	48	48	48	60
24,2	24	24	24	24	24	24	36	48	48	48	48
19,2	24	24	24	24	24	24	36	48	48	48	48
14,2	24	24	24	24	24	24	36	48	48	48	48

Courbes de charges / Lastkurven / Load curves / Curvas de cargas / Curve di carico / Curvas de carga / Кривые нагрузок



▼▲▲▲ (m)		12	15	20	25	30	35	40	42	45	47	50	52	55	57	60	62	65	67	70	72	75	77	80	m	
▼▲▲▲	32 t	▼▲▲▲	16 t	▼▲▲▲																						
80	4,2 → 13,1 4,2 → 14,2	22,9 - 25,1 24,6 - 27	32 27,2 19,1 32 30 21	16 12,9 10,7 9 16 14,2 11,8 9,9	8,5 7,7 7,3 8,5 8 7,4	6,4 5,9 5,6 5,7 5,4 5,1	4,9 4,6 4,4 4,8 4,5 4,3	3,9 3,7 3,5 4 3,9 3,6	3,3 t																	
75	4,2 → 13,6 4,2 → 14,7	23,9 - 26 25,7 - 28	32 28,5 20 32 31,3 22	16 13,5 11,2 9,5 16 14,9 12,4 10,5	9 8,2 7,7 9 8,5 7,9	6,8 6,3 6 6,6 6,1 5,8	5 4,7 4,4 5,2 4,9 4,7	4 4,3 4 4,4 t																		
70	4,2 → 15,3 4,2 → 16,6	27,1 - 29,4 29,2 - 32	32 32 23,3 17,7 32 32 25,6 19,5	15,7 13,1 11,1 10,5 16 14,4 12,2 11,5	9,6 9,1 8,4 8 10,6 10 9,3 8,8	8,2 7,8 7,2 6,9 6,4 6,2	5,8 5,5 5,2 5,8 t	4,9 4,7 4,4 5,8 t																		
65	4,2 → 16,8 4,2 → 18,2	29,7 - 32,3 32 - 35	32 32 26 19,9 32 32 28,6 21,8	16 14,6 12,5 11,8 16 13,7 12,8 11,7	10,8 10,3 9,5 9,1 11,7 11,1 10,2 9,7	8,4 8,1 7,6 7,2 8,5 7,9 7,6 7,1	6,8 t																			
60	4,2 → 17,9 4,2 → 18,4	31,7 - 34,5 34,1 - 36,8	32 32 28 21,5 17,1 32 32 29,4 23 18,7	15,7 13,4 12,7 11,7 16 14,6 13,8 12,7	11,1 10,3 9,8 9,1 11 10,4 9,6 9,2	8,2 t																				
55	4,2 → 18,4 4,2 → 18,7	32,6 - 35,5 34,7 - 37,3	32 32 29 22,2 17,8 32 32 29,9 23,4 19	16 13,9 13,2 12,1 11,5 16 14,8 14 12,9	10,7 10,2 9,5 t																					
50	4,2 → 19,5 4,2 → 19,6	34,7 - 37,8 36,6 - 39,2	32 32 31,1 23,9 19,2 32 32 31,4 24,6 20,1	16 15 14,1 13 12,4 16,8 15,6 14,8 13,7	11,5 t																					
45	4,2 → 19,6 4,2 → 19,6	34,8 - 38 35,8 - 38,4	32 32 31,3 24 19,3 32 32 31,3 24,2 19,7	16 15 14,2 13,1 16,4 15,3 14,5 13,4	t																					
40	4,2 → 19,7 4,2 → 19,8	35 - 38,1 36,5 - 39,2	32 32 31,4 24,1 19,4 32 32 31,6 24,8 20,2	16 15,1 t																						
35	4,2 → 20,1 4,2 → 20,1		32 32 32 24,7 19,8 32 32 32 25,1 20,3	16,4 t																						
30	4,2 → 19,5 4,2 → 19,5		32 32 31,2 23,9 19,2 32 32 31,2 24,1 19,6	t																						

▼▲▲▲ = ▼▲▲▲ - 1,98 t max.



▼▲▲▲ (m)		12	15	20	25	30	35	40	42	45	47	50	52	55	57	60	62	65	67	70	72	75	77	80	m	
▼▲▲▲	32 t	▼▲▲▲	16 t	▼▲▲▲																						
80	3,4 → 13,1 3,4 → 14,1	22,7 - 23,2 24,4 - 25	32 27 18,8 32 29,8 20,8	14,5 11,4 9,1 7,5 16 12,7 10,2 8,4	6,9 6,2 5,8 5,2 7,8 7 6,5 5,8	4,8 4,3 4 3,6 5,5 4,9 4,6 4,2	3,4 3,1 2,85 2,55 3,3 2,95 2,75 2,5	2,4 2,15 1,95 1,75 2,5 2,3 2,1 t																		
75	3,4 → 13,5 3,4 → 14,6	23,6 - 24,1 25,4 - 26	32 28,2 19,8 32 31,1 21,8	15,3 12,1 9,8 8 7,5 16,4 13,4 10,9 9	6,7 6,3 5,7 5,3 8,4 7,5 7 6,4	4,8 4,5 4,1 3,8 5,1 4,6 4,4 4	3,3 2,95 2,8 2,5 3,7 3,4 3,2 2,9	t																		
70	3,4 → 15,2 3,4 → 16,4	26,5 - 27,1 28,6 - 29,4	32 32 22,9 17,3 32 32 25,2 19,1	14,1 11,5 9,5 8,9 8,1 15,6 12,8 10,7 10	7,5 6,9 6,5 5,9 8,1 7,5 7,3 6,6	5,6 5,1 4,8 4,4 5,7 5,3 4,9 4,6	4,2 3,8 4,2 t																			
65	3,4 → 16,7 3,4 → 18,1	29,4 - 30,1 31,7 - 32,6	32 32 25,8 19,7 32 32 28,4 21,6	16 13,2 11,1 10,4 9,4 17,2 14,7 12,3 11,4	8,9 8,1 7,7 7,1 8,9 8,3 7,6 7,1	6,2 5,9 5,4 t																				
60	3,4 → 17,8 3,4 → 18,3	31,4 - 32,1 33,8 - 34,2	32 32 27,8 21,3 32 32 29,2 22,8	16,9 14,3 12,1 11,3 18,5 15,6 13,2 12,4	10,3 9,7 8,9 8,4 11,3 10,6 9,6 9	7,4 6,8 t																				
55	3,4 → 18,4 3,4 → 18,7	32,6 - 33,4 34,7 - 35	32 32 29 22,2 17,8 32 32 29,9 23,4 19	15,1 12,8 12 10,9 16 13,6 12,8 11,8	10,3 9,5 9 8,3 t																					
50	3,4 → 19,5 3,4 → 19,6	34,7 - 35,5 36,6 - 36,9	32 32 31,1 23,9 19,2 32 32 31,4 24,6 20,1	16 13,8 13 11,9 16,8 14,5 13,6 12,5	11,2 10,3 t																					
45	3,4 → 19,6 3,4 → 19,6	34,8 - 35,6 35,8 - 36,1	32 32 31,3 24 19,3 32 32 31,3 24,2 19,7	16 13,9 13 11,9 16,4 14,1 13,3 12,2	t																					
40	3,4 → 19,7 3,4 → 19,8	35 - 35,8 36,5 - 36,9	32 32 31,4 24,1 19,4 32 32 31,6 24,8 20,2	16 13,9 t																						
35	3,4 → 20,1 3,4 → 20,1		32 32 32 24,7 19,8 32 32 32 25,1 20,3	16,4 t																						
30	3,4 → 19,5 3,4 → 19,5		32 32 31,2 23,9 19,2 32 32 31,2 24,1 19,6	t																						

▼▲▲▲ = ▼▲▲▲ - 0,65 t max.

Lest de contre-flèche / Gegenauslegerballast / Counter-jib ballast / Lastre de contra-flecha / Zavorra di controbraccio / Lastro da contra lança / Противовес стрелы



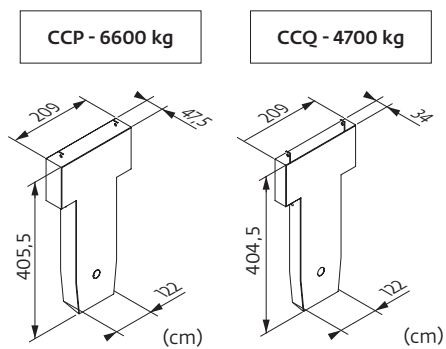









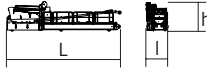
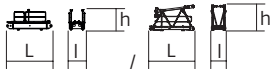

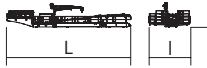
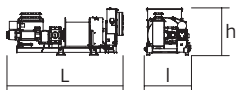



▼▲▲▲	6600 kg	4700 kg	▲▲▲ (kg)
80 m	6	0	39600
75 m	5	1	37700
70 m	5	1	37700
65 m	5	1	37700
60 m	4	2	35800
55 m	3	3	33900
50 m	7	0	46200
45 m	5	2	42400
40 m	6	0	39600
35 m	4	2	35800
30 m	4	1	31100



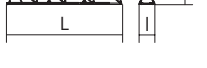
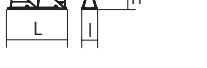



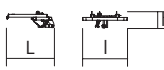



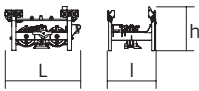

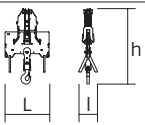

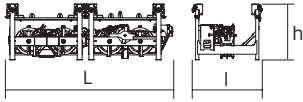

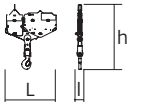

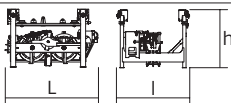

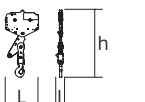

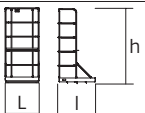
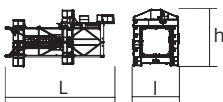

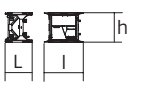

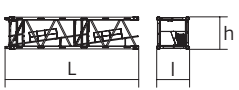
Encombremet et poids / Abmessungen und Gewicht / Dimensions and weight / Dimensiones y peso / Ingombro e peso
 dimensões e pesos / габаритные размеры и вес

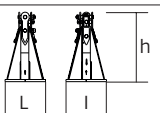
Partie tournante / Drehender Kranteil / Slewing crane part / Parte giratoria
 Parte rotante / Parte rotativa / Поворотная часть : 80 m - 150/180 HPL™

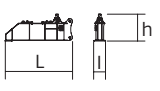

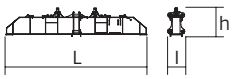
Partie tournante / Drehender Kranteil / Slewing crane part Parte giratoria / Parte rotante / Поворотная часть	L (m)	l (m)	h (m)	kg (+/- 5%)		
Contre-flèche / Gegenausleger Counter-jib / Contra-flecha Controbraccio / Contra-lança Контр-стрела		12	2,2	2,5	13465	
		12	2,2	2,5	17885	
		11,92	2,2	2,81	13415	
		4,56 4,34	1,62 1,38	2,02 2,46	4350 3170	
		16,25	6,69	3,93	15630	
		20,26	6,69	3,93	19660	
Treuil de levage (+ câble) / Hubwerk (+ Seil) Hoisting winch (+ rope) / Mecanismo de elevación (+ cabo) Argano di sollevamento (+ fune) Guincho de elevação (+ cabo) Подъемная лебедка (+ канатом)		150/180 HPL™	4,82	1,83	1,97	7575
Cabine / Kabine Cab / Cabina Cabina / Cabina Кабина Pivot / Krankopf Towerhead / Pivote Portaralla / Pivot Секция поворотной части		Ultra View	3,36	2,28	2,49	3000
		□ 2,45 m	2,68	2,49	3,03	12640
			6,68	2,49	3,03	15640
Élément de flèche / Auslegerelement Jib section / Elemento de flecha Elemento di braccio / Elemento de lança Секция стрелы		①	7,7	1,55	2,48	8665
		②	10,35	2,27	2,47	8770
		③	6,37	1,38	2,43	3245
		④	10,38	1,38	2,37	4295
		⑤	10,4	1,38	2,22	3225
		⑦	10,25	1,38	2,2	2265
		⑧	10,08	1,38	1,55	830
		⑨	5,36	1,38	2,22	1365
		⑩	5,3	1,38	2,13	780
			5,21	1,38	1,87	665
		5,18	1,38	1,57	565	
		1,67	1,57	0,58	265	

			L (m)	I (m)	h (m)	kg (+/- 5%)
Chariot / Laufkatze Trolley / Carrello Carro / Carro-distribuidor Тележка			2,63	1,75	1,58	1215
Moufle / Hubflasche Pulley block / Aparejo Bozzello / Cadernal Полиспаст			1,89	0,8	3,18	1415
Chariot / Laufkatze Trolley / Carrello Carro / Carro-distribuidor Тележка			4,2	1,8	1,5	1460
Moufle / Hubflasche Pulley block / Aparejo Bozzello / Cadernal Полиспаст			2,3	0,33	2,95	1310
Chariot / Laufkatze Trolley / Carrello Carro / Carro-distribuidor Тележка			2,1	1,8	1,5	780
Moufle / Hubflasche Pulley block / Aparejo Bozzello / Cadernal Полиспаст			1,52	0,33	3,05	810
Nacelle de chariot/ Arbeitsbühne an der Laufkatze Trolley inspection platform / Gondola de carro Navicella-carrelino/ Cesta do carro Платформа тележки			0,96	1,05	2,12	55
Pylône / Kranturm / Crane tower Mástil / Torre / Torre Башня крана						
T 851			11,18	4,84	5,8	15750
K 84/K 84-2			2,24	3,24	2,5	3050
KRM 849B K 85/KR 84B2 KM 850.10B KM 850.14B K 85/KR 84A2 KMT 850.10A KMT 850.14A K 849A KMT 849A KR 849A KRMT 849A KRMT 849C KMT 850.10C			10,24 10,24 10,32 10,32 5,24 5,32 5,32 5,23 5,23 5,23 5,23 3,57 3,65	2,55 2,54 2,54 2,54 2,54 2,54 2,54 2,53 2,53 2,55 2,53 2,55 2,54	2,53 2,5 2,51 2,51 2,5 2,51 2,51 2,5 2,53 2,53 2,53 2,53 2,53 2,51	7800 9635 10070 11190 5550 5450 5990 3400 3150 4290 4090 3205 4230
Pieds de scellement / Verankerungsfüße Fixing angles / Pie de empotramiento Montante da annegare / Angulos fixadores анкера			0,75 0,9	0,75 0,9	1,28 1,5	465 940
1/2 Bras de croix / 1/2 Fundamentkreuzträger 1/2 Cross girder / 1/2 Brazo en cruz 1/2 Braccio croce / 1/2 Braço da cruz 1/2 Поперечная балка			5,68 5,7	0,98 0,98	1,92 2,27	4720 6430
Bras de croix / Fundamentkreuzträger Cross girder / Brazo en cruz Braccio croce / Braço da cruz Поперечная балка			11,96 11,9	1,39 1,42	1,92 2,27	10075 14000

Mécanismes / Triebwerke / Mechanisms / Mecanismos / Meccanismi
 Mecanismos / Механизмы

400 V - 50 Hz 480 V - 60 Hz													ch - PS hp	kW		
	400 V - 50 Hz	150 HPL™ 80	m/min	35,5	45,5	62,5	103	151	18	23	31,5	53,5	75,5	150	110	506 m
			t	16	12	8	4	1,8	32	24	16	8	4,7			
	480 V - 60 Hz	180 HPL™ 80	m/min	42,5	52,5	70	109	151	21,5	26,5	35	56	75,5	180	132	
			t	16	12	8	4	1,8	32	24	16	8	4,7			
		15 DVF 16 Optima	m/min	0 → 33 (32 t) 0 → 50 (20 t) 0 → 67 (10 t) 0 → 100 (2,5 t)									15	11		
	400 V - 50 Hz 480 V - 60 Hz	RVF 174 Optima+	tr/min U/min rpm	0 → 0,7									4 x 10	4 x 7,5		

IEC 60204-32	
400 V (+10% -10%) 50 Hz	150 HPL™ : 170 → 110 kVA
480 V (+6% -10%) 60 Hz	180 HPL™ : 194 → 122 kVA

	FR	DE	EN	ES	IT	PT	RU
	Appel de flèche	Auslegerüberhöhung	Jib elevation	Elevación de la flecha	Inclinazione braccio	Desvio da lança	подъем стрелы
	Équipements standards	Standardausrüstungen	Standard equipment	Equipamiento de serie	Equipaggiamento standard	Equipamento de série	Стандартное оборудование
	Équipements optionnels	Sonderausrüstungen	Options	Equipamiento opcional	Equipaggiamento in opzione	Equipamento opcional	Дополнительное оборудование (опция)
	Fonction Potain Plus : Courbes de charges Plus	Funktion Potain Plus: Plus-Lastkurven	Potain Plus function: Plus load curves	Función Potain Plus: Diagrama de cargas Plus	Funzione Potain Plus: Curve di carico Plus	Função Potain Plus: Diagrama de cargas Plus	Функция контроля мощности Potain Plus: Диаграммы грузоподъемности Plus
	Hauteurs sous crochet associées aux courbes de charges Plus	Hakenhöhen mit Plus-Lastkurven	Hook heights with Plus load curves	Altura bajo gancho, usando el diagrama de cargas Plus	Altezze sotto gancio con curve di carico Plus	Altura livre, utilizando o diagrama de cargas Plus	Высота под крюком для диаграмм грузоподъемности Plus
	Réactions en service	Reaktionskräfte in Betrieb	Reactions in service	Reacciones en servicio	Reazioni in servizio	Reacções em serviço	Реакция при работе
	Réactions hors service	Reaktionskräfte außer Betrieb	Reactions out of service	Reacciones fuera de servicio	Reazioni fuori servizio	Reacções fora de serviço	Реакция в покое
	Poids total du lest	Ballast-Gesamtgewicht	Total ballast weight	Peso total del lastre	Peso totale della zavorra	Peso total do lastro	Общий вес балласта
	Cadre d'ancrage serré	Fester Verankerungsrahmen	Tightened anchorage frame	Marco de anclaje de apriete	Quadro di ancoraggio stretto	Quadro de amarração apertado	Прикрепленная анкерная рама
	Cadre d'ancrage desserré	Looser Verankerungsrahmen	Loosened anchorage frame	Marco de anclaje de desapriete	Quadro di ancoraggio allentato	Quadro de amarração solto	Отсоединенная анкерная рама
	Camion 13,4 m	Lkw 13,4 m	Lorry 13,4 m	Camión 13,4 m	Camion 13,4 m	Camião 13,4 m	Рзрузовой автомобиль 13,4 м
	Conteneur High Cube 40', et/ou Flat Rack 20'	Container High Cube 40', und/oder Flat Rack 20'	Container High Cube 40', and/or Flat Rack 20'	Contenedor High Cube 40', y/o Flat Rack 20'	Container High Cube 40', e/o Flat Rack 20'	Contentor High Cube 40', e/ou Flat Rack 20'	40-футовый контейнер повышенной вместимости High Cube, и/или 20-футовая открытая платформа Flat Rack
	Levage	Heben	Hoisting	Elevación	Sollevamento	Elevação	Подъем
	Distribution	Katzfahren	Trolleying	Distribución	Distribuzione	Distribuição	Перемещение по стреле
	Orientation	Schwenken	Slewing	Orientación	Rotazione	Rotação	Поворот
	Translation	Kranfahren	Travelling	Traslación	Traslazione	Translação	Перемещение крана
	Puissance requise	Erforderliche Leistung	Required power	Potencia Necesaria	Potenza richiesta	Potência Necessária	Потребляемая мощность
	Fonction Power Control : vitesses treuils adaptées à la puissance disponible	Funktion Power Control: Geschwindigkeiten der Triebwerke werden an die verfügbare Leistung angepasst	Power Control Function: winch speeds adapted to the available power	Función Power Control: marchas de los cabrestantes adaptadas a la potencia disponible	Funzione Power Control: velocità degli argani adattate alla potenza disponibile	Função Power Control: velocidades de guincho adaptadas à potência disponível	Функция контроля мощности Power Control: регулировка скорости лебедок в зависимости от доступной мощности
	Nous consulter	Auf Anfrage	Consult us	Consultarnos	Consultateci	Consultar-nos	Проконсультируйтесь у нас
	Document commercial non contractuel. Pour toute information technique se référer à la notice correspondante.	Unverbindliches Vertriebsdokument. Für technische Informationen, siehe die entsprechenden Anweisungen.	This commercial document is not legally binding. For any technical information, please refer to the corresponding instructions.	Documento comercial no contractual. Para cualquier información técnica, ver la noticia correspondiente.	Documento commerciale non vincolante, per tutte le informazioni tecniche fare riferimento al catalogo istruzioni.	Documento comercial não contratual. Para qualquer informação técnica complementar consultar as respectivas instruções.	Этот коммерческий документ не является юридически обязательным. Для получения технической информации, см. соответствующие инструкции.

