

MDT 269 J12

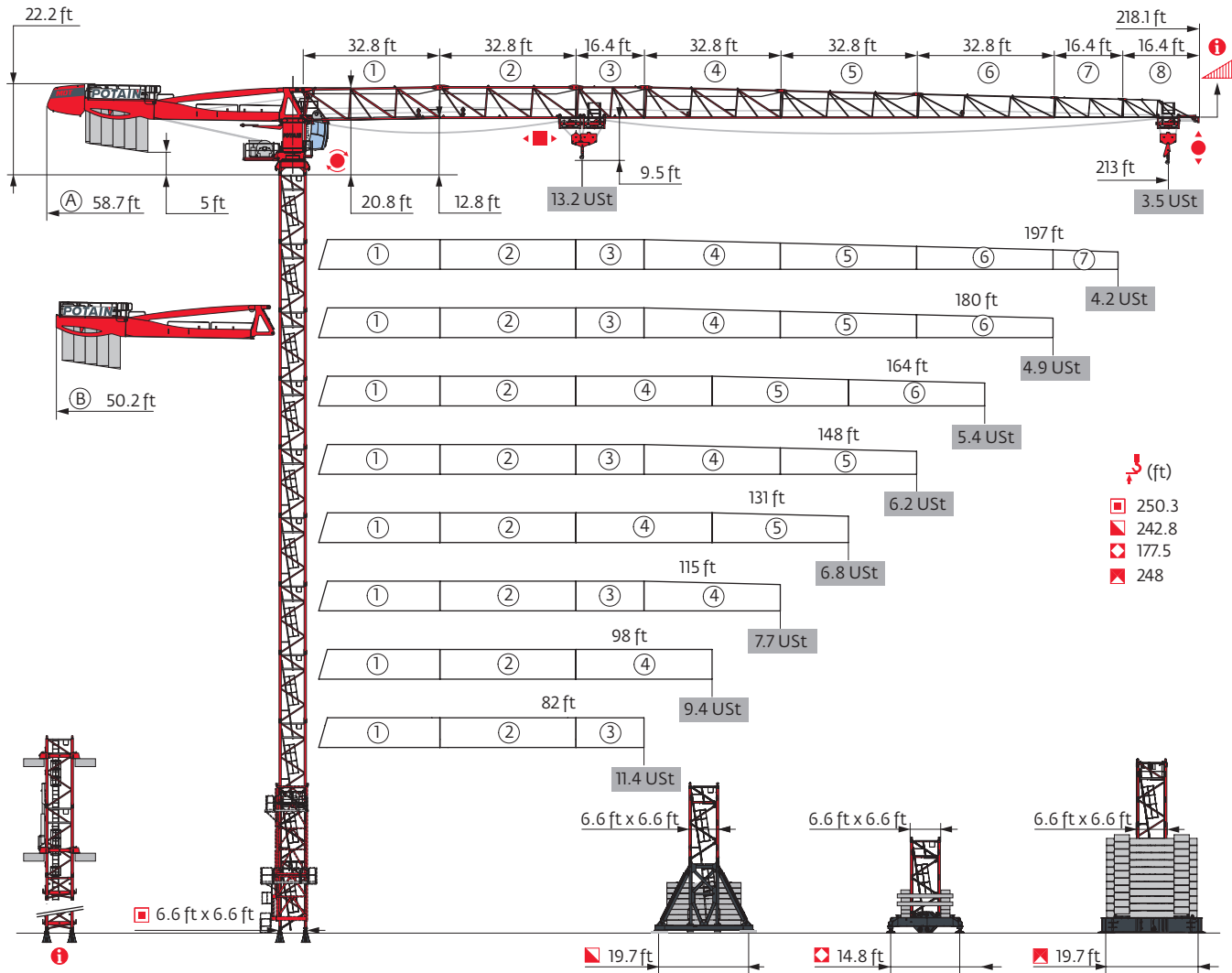

Potain Plus



Power Control

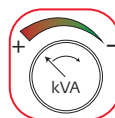

Top Site



Top Tracing 3

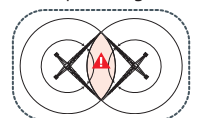

Mast - Reactions

6.6 ft - P 63A

Height (ft)	82	98	115	131	148	164	180	197	213
Height (ft)	250.3	245.1	239.5	239.5	239.5	239.5	233.9	228.7	228.7
Height/P _r (ft)	250.3	245.1	239.5	239.5	239.5	239.5	233.9	228.7	228.7
10.9 ft	0	1	2	2	2	2	0	1	1
16.4 ft	13	12	11	11	11	11	12	11	11
32.8 ft	1	1	1	1	1	1	1	1	1
F2 (USt)	● 221 ■ 385	216 370	215 361	215 359	216 367	216 368	211 348	214 330	215 337
F3 (USt)	● 162 ■ 332	156 317	154 307	153 304	153 310	153 311	147 290	149 272	150 278

6.6 ft - V 60A -



Height (ft)	82	98	115	131	148	164	180	197	213
Height (ft)	215.2	215.2	215.2	215.2	215.2	215.2	220.8	215.2	215.2
Height/P _r (ft)	215.2	215.2	215.2	215.2	215.2	215.2	220.8	215.2	215.2
10.9 ft	0	0	0	0	0	0	2	0	0
16.4 ft	12	12	12	12	12	12	11	12	12
F1 (USt)	● 114 ■ 147	113 146	115 149	114 147	115 150	115 151	121 158	116 148	120 153

6.6 ft - V 63A -

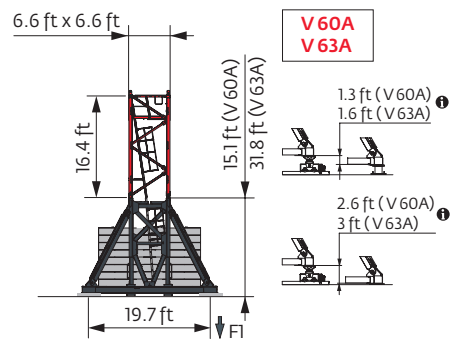
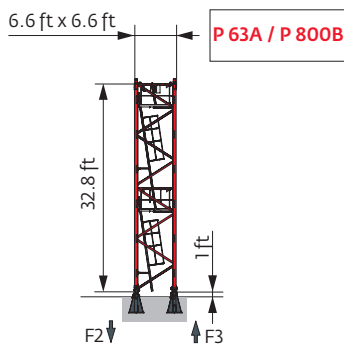

Height (ft)	82	98	115	131	148	164	180	197	213
Height (ft)	237.2	237.2	237.2	242.8	237.2	237.2	231.6	231.6	231.6
Height/P _r (ft)	237.2	237.2	237.2	242.8	237.2	237.2	231.6	231.6	231.6
10.9 ft	2	2	2	1	2	2	0	0	0
16.4 ft	11	11	11	12	11	11	12	12	12
F1 (USt)	● 135 ■ 184	134 183	136 187	137 193	136 189	136 189	131 177	132 176	133 180



6.6 ft - ZD 463 - 

W (ft)	82	98	115	131	148	164	180	197	213
 (ft)	171.9	177.5	171.9	177.5	171.9	171.9	166.3	166.3	166.3
 / P _r (ft)	171.9	171.9	171.9	177.5	171.9	171.9	161.1	161.1	161.1
	10.9 ft	0	2	0	2	0	0	1	1
	16.4 ft	10	9	10	9	10	10	9	9
F _l (Ust)	● 113	115	114	115	111	111	115	115	116
	■ 125	134	127	134	128	129	120	119	124

6.6 ft - ZX 640 - 

W (ft)	82	98	115	131	148	164	180	197	213
 (ft)	248	248	242.5	242.5	242.5	242.5	237.2	231.6	231.6
 / P _r (ft)	248	248	242.5	242.5	242.5	242.5	237.2	231.6	231.6
	10.9 ft	1	1	2	2	2	0	1	1
	16.4 ft	12	12	11	11	11	12	11	11
	32.8 ft	1	1	1	1	1	1	1	1
F _l (Ust)	● 142	142	139	140	143	143	137	132	133
	■ 197	197	192	190	195	195	183	172	176

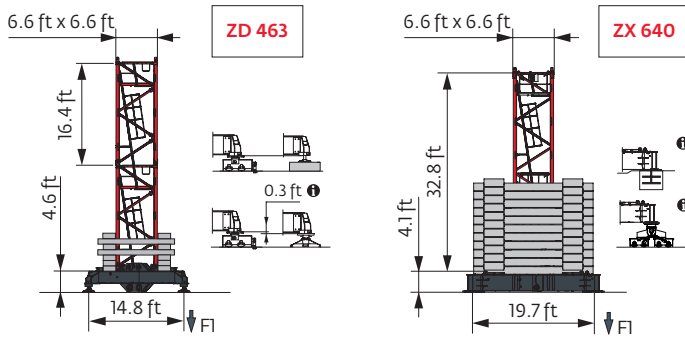

Note: When "ASCE" is noted in this data sheet it is referring to 115 mph Wind Zone, Exposure B, Design Wind Speed = 98 mph. See back cover for design wind speed calculations.

 Motorized accesses: adapted mast compositions, base ballast and reactions.

Other mast compositions - Please consult us

Anchorage



Base ballast

Ust) / 6.6 ft - V 60A -

Δ (ft)	82	98	115	131	148	164	180	197	213
220.8	145.5								
215.2	145.5	145.5	145.5	145.5	145.5	145.5	132.3	132.3	145.5
198.8	119.1	119.1	119.1	105.8	105.8	119.1	105.8	105.8	105.8
182.4	92.6	92.6	92.6	79.4	79.4	79.4	92.6	92.6	92.6
166	79.4	79.4	79.4	66.1	66.1	66.1	79.4	79.4	79.4
149.6	66.1	66.1	66.1	52.9	52.9	52.9	66.1	66.1	66.1
133.2	52.9	52.9	52.9	52.9	39.7	39.7	52.9	52.9	52.9
116.8	52.9	52.9	52.9	52.9	39.7	39.7	39.7	39.7	39.7
100.4	52.9	52.9	52.9	52.9	39.7	39.7	39.7	26.5	26.5
84	52.9	52.9	52.9	52.9	39.7	39.7	39.7	26.5	26.5
67.6	52.9	52.9	52.9	52.9	39.7	39.7	39.7	26.5	26.5

Ust) / 6.6 ft - V 63A -

Δ (ft)	82	98	115	131	148	164	180	197	213
242.8	198.4								
237.2	198.4	198.4	198.4	198.4	198.4	198.4			
231.6	185.2	185.2	185.2	185.2	185.2	185.2	172	172	172
215.2	145.5	145.5	145.5	145.5	145.5	145.5	145.5	132.3	145.5
198.8	119.1	119.1	119.1	119.1	119.1	119.1	105.8	119.1	119.1
182.4	92.6	92.6	92.6	92.6	92.6	92.6	92.6	92.6	92.6
166	79.4	79.4	79.4	66.1	66.1	66.1	79.4	79.4	79.4
149.6	66.1	66.1	66.1	52.9	52.9	52.9	66.1	66.1	66.1
133.2	52.9	52.9	52.9	39.7	39.7	39.7	52.9	52.9	52.9
116.8	39.7	39.7	39.7	39.7	39.7	39.7	39.7	39.7	39.7
100.4	39.7	39.7	39.7	39.7	39.7	39.7	39.7	26.5	26.5
84	39.7	39.7	39.7	39.7	39.7	39.7	39.7	26.5	26.5
67.6	39.7	39.7	39.7	39.7	39.7	39.7	39.7	26.5	26.5

Ust) / 6.6 ft - ZD 463 -

Δ (ft)	82	98	115	131	148	164	180	197	213
177.5	137.8		132.3						
171.9	132.3	126.8	132.3	126.8	121.3	121.3			
166.3	126.8	121.3	126.8	121.3	115.7	115.7	132.3	132.3	132.3
149.9	104.7	104.7	104.7	99.2	93.7	93.7	110.2	110.2	110.2
133.5	88.2	88.2	82.7	82.7	82.7	82.7	88.2	93.7	88.2
117.1	88.2	88.2	82.7	82.7	82.7	82.7	77.2	71.7	71.7
100.7	88.2	88.2	82.7	82.7	82.7	82.7	77.2	66.1	60.6
84.3	88.2	88.2	82.7	82.7	82.7	82.7	77.2	66.1	60.6
67.9	88.2	88.2	82.7	82.7	82.7	82.7	77.2	66.1	60.6

Ust) / 6.6 ft - ZX 640 -

Δ (ft)	82	98	115	131	148	164	180	197	213
248	209.4 209.4								
242.5	198.4	198.4	198.4	198.4	209.4	209.4			
237.2	187.4	187.4	187.4	187.4	187.4	187.4	187.4		
231.6	176.4	176.4	176.4	165.4	176.4	176.4	176.4	165.4	165.4
215.2	143.3	132.3	143.3	132.3	143.3	143.3	132.3	143.3	143.3
198.8	110.2	110.2	110.2	110.2	110.2	110.2	110.2	121.3	121.3
182.4	99.2	88.2	99.2	99.2	88.2	88.2	88.2	99.2	99.2
166	77.2	77.2	77.2	77.2	77.2	77.2	77.2	88.2	77.2
149.6	66.1	66.1	66.1	66.1	55.1	55.1	55.1	66.1	66.1
133.2	44.1	44.1	44.1	44.1	44.1	44.1	44.1	55.1	44.1
116.8	44.1	44.1	44.1	44.1	44.1	44.1	33.1	33.1	33.1
100.4	44.1	44.1	44.1	44.1	44.1	44.1	33.1	22.1	22.1
84	44.1	44.1	44.1	44.1	44.1	44.1	33.1	22.1	22.1
67.6	44.1	44.1	44.1	44.1	44.1	44.1	33.1	22.1	22.1

Load curves



▽ (ft)		56	66	72	82	89	98	105	115	121	131	138	148	154	164	171	180	187	197	203	213	ft	
▽	▽ 13.2 USt	▽										▽											
▽	▽ 6.6 USt	▽										▽											
213	10 → 62	114 - 122	13.2	12.5	11.2	9.8	8.9	7.9	7.3	6.6	6.6	6.1	5.7	5.2	4.9	4.6	4.3	4	3.8	3.6	3.4	3.2	USt
	10 → 66	118 - 126	13.2	13.2	12	10.4	9.4	8.3	7.7	6.9	6.6	6.4	6	5.5	5.2	4.8	4.6	4.3	4.1	3.9	3.7	3.5	USt P+
197	10 → 66	122 - 129	13.2	13.2	12.1	10.5	9.6	8.5	7.9	7.1	6.7	6.5	6.1	5.6	5.3	4.9	4.6	4.3	4.1	3.9			USt
	10 → 70	126 - 135	13.2	13.2	12.7	11.1	10.1	9	8.2	7.4	6.9	6.6	6.4	5.9	5.6	5.2	4.9	4.6	4.4	4.2			USt P+
180	10 → 66	121 - 131	13.2	13.2	11.9	10.3	9.5	8.4	7.8	7	6.6	6.6	6.2	5.8	5.5	5.1	4.9	4.6					USt
	10 → 69	130 - 141	13.2	13.2	12.6	11.1	10.2	9.1	8.4	7.6	7.2	6.6	6.6	6.2	5.9	5.5	5.3	4.9					USt P+
164	10 → 66	118 - 127	13.2	13.2	11.8	10.2	9.3	8.2	7.6	6.8	6.6	6.4	6	5.6	5.3	4.9							USt
	10 → 68	127 - 138	13.2	13.2	12.4	10.8	9.9	8.8	8.2	7.4	7	6.6	6.6	6.1	5.8	5.4							USt P+
148	10 → 66	119 - 128	13.2	13.2	11.9	10.2	9.4	8.3	7.6	6.9	6.6	6.4	6.1	5.6									USt
	10 → 69	128 - 138	13.2	13.2	12.5	10.9	10	8.9	8.3	7.5	7	6.6	6.6	6.2									USt P+
131	10 → 68	125 - 131	13.2	13.2	12.3	10.7	9.8	8.7	8.1	7.3	6.9	6.6											USt
	10 → 71		13.2	13.2	13.1	11.4	10.5	9.3	8.7	7.9	7.4	6.8											USt P+
115	10 → 66		13.2	13.2	12	10.4	9.5	8.5	7.9	7.1													USt
	10 → 69		13.2	13.2	12.7	11.1	10.2	9.1	8.5	7.7													USt P+
98	10 → 68		13.2	13.2	12.4	10.8	9.9	8.8															USt
	10 → 72		13.2	13.2	13.1	11.5	10.5	9.4															USt P+
82	10 → 67		13.2	13.2	12.3	10.7																	USt
	10 → 71		13.2	13.2	13	11.3																	USt P+

$▽ = ▽ - 0.58 \text{ USt max.}$



▽ (ft)		56	66	72	82	89	98	105	115	121	131	138	148	154	164	171	180	187	197	203	213	ft	
▽	▽ 13.2 USt	▽										▽											
▽	▽ 6.6 USt	▽										▽											
213	8 → 62	115 - 116	13.2	12.5	11.3	9.8	9	8	7.4	6.6	6.3	5.7	5.3	4.9	4.6	4.2	4	3.7	3.5	3.2	3.1	2.85	USt
	8 → 66	120 - 120	13.2	13.2	12.1	10.5	9.5	8.4	7.8	7	6.5	6	5.6	5.2	4.9	4.5	4.2	3.9	3.7	3.5	3.3	3.1	USt P+
197	8 → 67	123 - 123	13.2	13.2	12.1	10.5	9.7	8.6	8	7.2	6.7	6.2	5.8	5.3	5	4.6	4.3	4	3.8	3.6			USt
	8 → 70	127 - 128	13.2	13.2	12.8	11.1	10.2	9	8.3	7.5	7	6.4	6.1	5.6	5.3	4.9	4.6	4.3	4.1	3.8			USt P+
180	8 → 66	122 - 125	13.2	13.2	12	10.4	9.5	8.5	7.9	7.1	6.7	6.2	5.9	5.4	5.2	4.8	4.6	4.2					USt
	8 → 70	131 - 133	13.2	13.2	12.7	11.1	10.3	9.1	8.5	7.7	7.2	6.6	6.4	5.9	5.6	5.2	4.9	4.6					USt P+
164	8 → 66	119 - 121	13.2	13.2	11.9	10.3	9.4	8.3	7.7	6.9	6.6	6	5.7	5.2	5	4.6							USt
	8 → 68	128 - 130	13.2	13.2	12.5	10.9	10	8.9	8.3	7.5	7	6.6	6.2	5.7	5.5	5.1							USt P+
148	8 → 66	120 - 122	13.2	13.2	11.9	10.3	9.4	8.3	7.7	6.9	6.6	6.1	5.8	5.3									USt
	8 → 69	129 - 132	13.2	13.2	12.6	11	10.1	9	8.4	7.6	7.1	6.6	6.3	5.8									USt P+
131	8 → 68	126 - 129	13.2	13.2	12.4	10.8	9.9	8.8	8.2	7.4	6.9	6.5											USt
	8 → 72		13.2	13.2	13.1	11.5	10.5	9.4	8.8	7.9	7.5	6.8											USt P+
115	8 → 66		13.2	13.2	12	10.5	9.6	8.5	7.9	7.1													USt
	8 → 70		13.2	13.2	12.7	11.2	10.3	9.2	8.5	7.7													USt P+
98	8 → 68		13.2	13.2	12.5	10.9	10	8.9															USt
	8 → 72		13.2	13.2	13.2	11.5	10.6	9.4															USt P+
82	8 → 68		13.2	13.2	12.3	10.7																	USt
	8 → 71		13.2	13.2	13.1	11.4																	USt P+

$▽ = ▽ - 0.19 \text{ USt max.}$

Jib weight & counter-jib ballast

▽ (ft)	▽ (lb) (+/- 5%)			▽ (lb)			▽ (lb)			CBS - 10,141 lb	CBU - 6,768 lb	CBY - 3,373 lb
	▽	▽	▽	▽	▽	▽	▽	▽	▽			
213 ft	27,761	26,985	27,961	5	1	54,079	7	2	54,123			
197 ft	27,090	26,381	27,247	5	1	54,079	7	2	54,123			
180 ft	26,420	25,710	26,577	5	0	50,706	7	1	50,750			
164 ft	24,562	23,852	24,718	4	1	43,938	6	1	43,982			
148 ft	24,877	24,167	25,033	4	1	43,938	6	1	43,982			
131 ft	23,089	22,379	23,246	4	0	40,565	6	0	40,609			
115 ft	22,824	22,115	22,981	3	2	37,170	5	1	37,214			
98 ft	20,723	20,014	20,880	3	1	33,797	5	0	33,841			
82 ft	19,557	18,847	19,714	3	0	30,424	4	1	30,446			

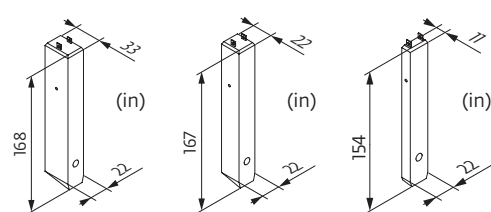



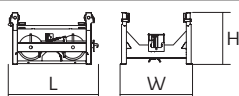
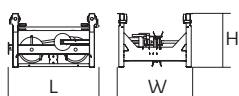
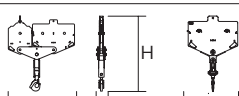

Dimensions and weight

Slewing crane part:  213 ft -  50 LVF

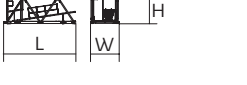
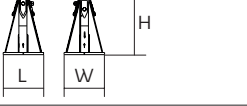

Slewing crane part			L (ft)	W (ft)	H (ft)	lb (+/- 5%)
Counter-jib		Ⓐ Ⓑ	36.1 36.1	3.8 3.8	8.1 8.1	19,213 18,629
Cab mast + cab		Ultra View	16.1	7.3	8.2	11,684
Towerhead + Hoisting winch (+ rope)		 6.6 ft 50 LVF	16.9	8.2	9.1	18,684
Towerhead		 6.6 ft	9.3	8.1	8.1	11,684
Hoisting winch (+ rope)		90 HPL™	14	7.5	7.6	9,921
Jib section		① 6 DVF	35.5	5.6	9	7,959
Jib section		② ④ ⑤ ⑥	33.8 33.5 33.6 33.4	3.9 3.9 3.9 3.9	7.9 7.8 6.9 6	5,335 3,439 2,723 1,753
jib section		③ ⑦ ⑧	17.3 16.7 16.7	3.9 3.9 3.9	7.8 5 4.6	2,116 683 485
Trolley		 13.2 USt	6.1	5	3.4	882
Pulley block		 13.2 USt	3.9	1.4	7.6	1,003
Trolley		 13.2 USt	5.2	5	3.2	463
Trolley		 13.2 USt  6.6 USt	5.6 6.1	5 5	3.4 3.2	540 520
Trolley		 13.2 USt  6.6 USt	5.4 3.6	0.7 0.9	5.8 5.3	992 584

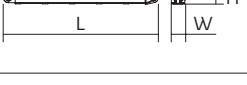
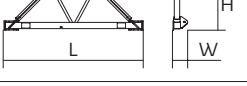
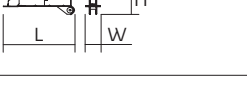
Crane tower			L (ft)	W (ft)	H (ft)	lb (+/- 5%)
Telescopic cage T 61		□ 6.6 ft	35.5	13.6	14.7	21,385
K 649B KM 649E KRM 6410B		□ 6.6 ft	33.6 33.8 33.6	6.8 6.7 6.9	6.7 6.7 6.8	11,663 10,692 15,653
KR 649A KRMT 649A K 649A KMT 649A		□ 6.6 ft	17.2 17.2 17.2 17.2	6.9 6.9 6.8 6.8	6.8 6.8 6.7 6.7	7,165 6,724 6,184 5,666
K 649C KMT 649C KRMT 649C		□ 6.6 ft	11.7 11.7 11.7	6.8 6.8 6.9	6.7 6.7 6.8	4,376 4,542 5,401
Fixing angles		P 63A / P 800B	2.5	2.5	4.2	1,025
Basic mast unit		V 60A V 63A	16.4 32.9	7.9 7.9	7.9 7.9	10,494 16,887
Struts		V 60A V 63A	14.8 14.8	1 1.1	1 1.1	1,036 1,235
Half-bearer		V 60A V 63A	22 22	2.3 2.3	7.6 7.6	4,057 4,101
Cross girder		ZD 463	25.1	3.8	4.5	7,904
1/2 Cross girder		ZD 463	11.2	2.3	4.4	3,649
1/2 Cross girder		ZX 640	14.3	3.3	5.1	7,319
Cross girder		ZX 640	30	3.9	5.1	15,168

Mechanisms

480 V - 60 Hz											hp	kW			
	50 LVF 30 Optima	fpm	105	135	185	267	54	71	97	135	50	37	1,106 ft		
		USt	6.6	5	3.3	1.1	13.2	9.9	6.6	2.5					
	90 HPL™ 30	fpm	176	228	326	469	723	90	120	172	244	361	90	66	2,772 ft
		USt	6.6	5	3.3	1.7	0.2	13.2	9.9	6.6	3.3	0.9			
	6 DVF 4 Optima	fpm	0 → 164 (13.2 USt)				0 → 328 (6.6 USt)		0 → 394 (3.3 USt)		5.5	4			
	RVF 162 Optima+	rpm	0 → 0.9									2 x 7.5	2 x 5.5		

480 V (+6% -10%) 60 Hz	50 LVF: 58 → 38 kVA	
	90 HPL™: 90 → 54 kVA	

50 LVF 30 Optima

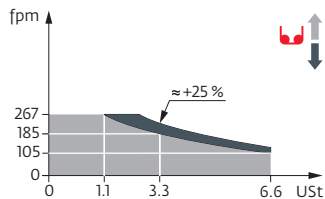

These most combinations meet the EN 14439 and ASME B30.3-2016 specifications for “out of service” wind conditions, provided the illustrated wind speed matches required design wind speed for the location of the tower crane. The “out of service” design wind speed was determined in accordance with ASCE 7-10, Figure 26.5-1A. The wind velocity, used for this configuration was 98 mph (158 kph), which represents a nominal design 3-second wind gust at 33 ft (10 m) above ground for Exposure B category. A factor of 0.85 was applied to the 700-year ultimate design wind speed of 115 mph (185 kph), per ASCE 37-02, with the assumption that this crane is considered a temporary structure used during a construction period of 2 years or less.

- Jib elevation
- Standard equipment
- Options
- Total ballast weight
- Jib weight
- Travelling
- Potain Plus function: Plus load curves
- Lorry 44 ft
- Required power
- Hook heights with Plus load curves
- Container High Cube 40 ft, and/or Flat Rack 20 ft
- Power Control Function: winch speeds adapted to the available power
- Reactions in service
- Hoisting
- Consult us
- Reactions out of service
- Trolleying
- Slewing

This commercial document is not legally binding. For any technical information, please refer to the corresponding instructions.

