

MDT 249 J10

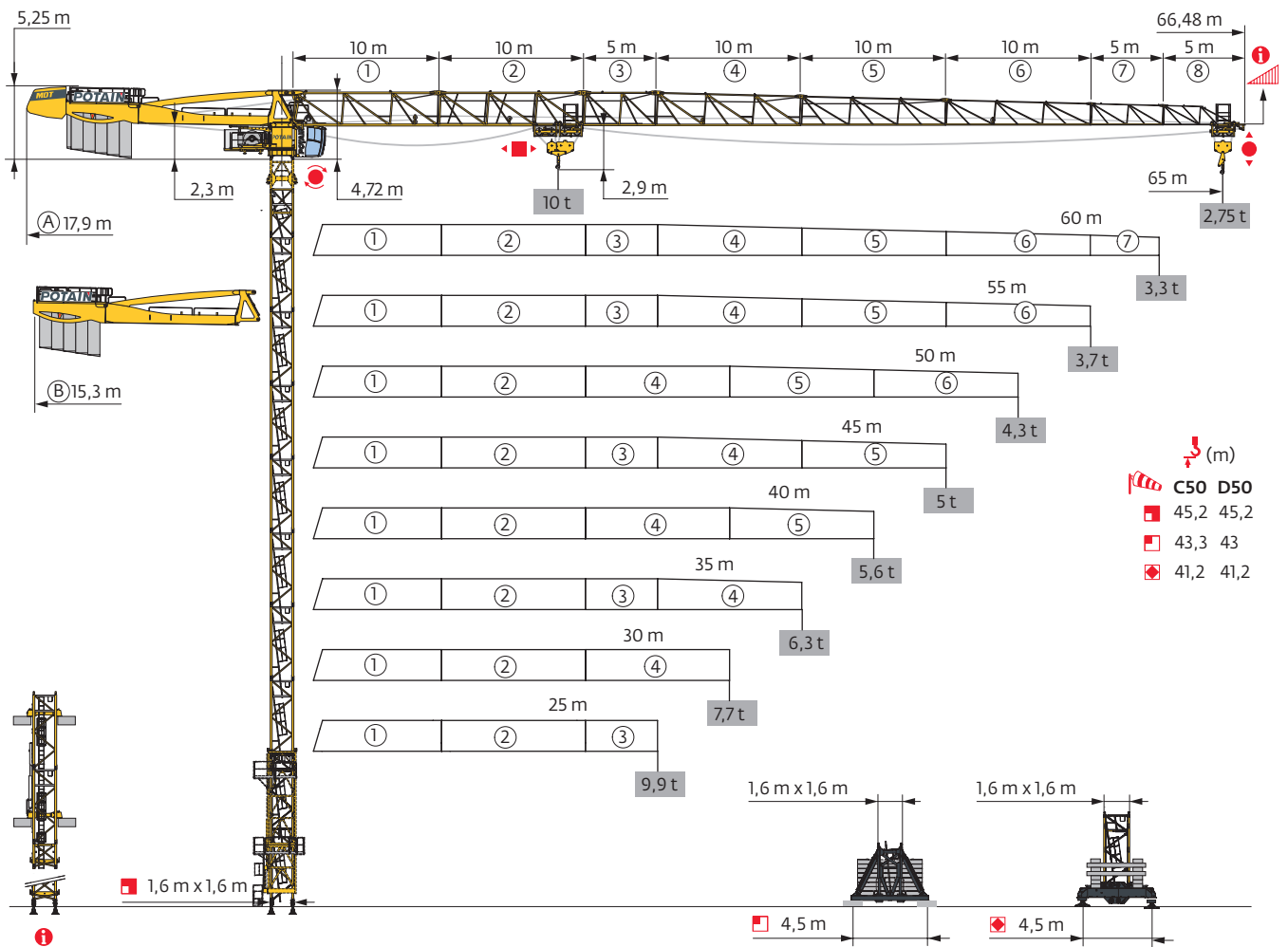

Potain Plus



Power Control

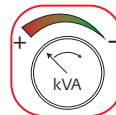

Top Site

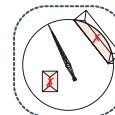

Top Tracing 3

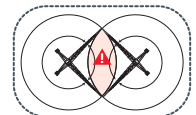

Mât - Réactions / Mast - Reaktionskräfte / Mast - Reactions / Mástil - Reacciones / Torre - Reazioni
 Tramo - Reacções / Реакция опор мачты

1,6 m City - P 42A - C50										
h (m)	25	30	35	40	45	50	55	60	65	
h (m)	44,8	44,8	44,8	43,2	44,8	44,8	44,8	41,5	41,5	
h/P ₊ (m)	44,8	44,8	44,8	43,2	44,8	44,8	44,8	41,5	41,5	
h _{max} (m)	3,33 m	0	0	0	1	0	0	0	2	2
	5 m	7	7	7	6	7	7	7	5	5
	10 m	1	1	1	1	1	1	1	1	1
F2 (t)	● 139	138	135	134	133	131	132	129	130	
	■ 134	134	139	126	144	146	153	128	136	
F3 (t)	● 108	106	102	101	93	91	91	92	88	
	■ 103	102	107	92	109	111	117	92	99	
h (m) D50	44,8	44,8	44,8	43,2	44,8	44,8	44,8	41,5	41,5	
h/P ₊ (m) D50	44,8	44,8	44,8	43,2	44,8	44,8	44,8	41,5	41,5	

1,6 m City - S 41A - C50										
h (m)	25	30	35	40	45	50	55	60	65	
h (m)	43	43	43	43	43	43	41,3	39,7	41,3	
h/P ₊ (m)	43	43	43	43	43	43	41,3	39,7	41,3	
h _{max} (m)	3,33 m	0	0	0	0	0	0	1	2	1
	5 m	8	8	8	8	8	8	7	6	7
F1 (t)	● 83	83	83	82	81	81	84	81	85	
	■ 78	78	80	78	79	79	81	74	83	
h (m) D50	39,7	39,7	39,7	41,3	43	43	39,7	39,7	39,7	
h/P ₊ (m) D50	39,7	39,7	39,7	41,3	43	43	39,7	39,7	39,7	

1,6 m City - ZD 463 - C50										
h (m)	25	30	35	40	45	50	55	60	65	
h (m)	40,9	40,9	40,9	40,9	40,9	40,9	39,2	37,6	39,2	
h/P ₊ (m)	40,9	40,9	40,9	40,9	40,9	40,9	39,2	37,6	39,2	
h _{max} (m)	3,33 m	0	0	0	0	0	1	2	1	
	5 m	8	8	8	8	8	7	6	7	
F1 (t)	● 80	80	80	79	79	78	80	79	82	
	■ 74	73	75	73	75	75	73	70	77	
h (m) D50	40,9	40,9	40,9	40,9	40,9	40,9	39,2	37,6	39,2	
h/P ₊ (m) D50	40,9	40,9	40,9	40,9	40,9	40,9	39,2	37,6	39,2	

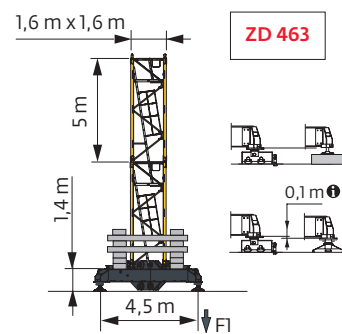
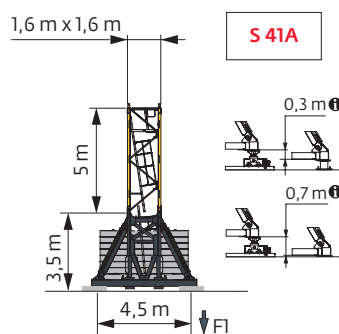
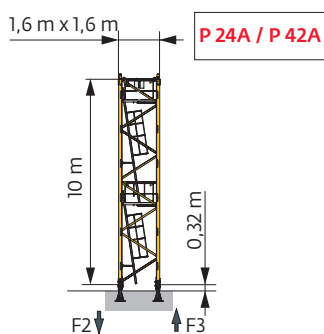

Autres compositions de pylône - Nous consulter. / Andere Turmaufbauten - bitte kontaktieren Sie uns. / Other mast compositions - Please consult us. / Para otras composiciones de mástil - Por favor contactémos. / Per altre composizioni torre, contattateci. / Para outras composições de coluna - Por favor, consulte-nos. / Для других композиций мачты пожалуйста консультируйтесь с нами.

Accès motorisés : compositions de mât, de lest de base et réactions adaptées. / Motorisierter Zugang vom Mastzusammensetzung, Grundballast und Reaktionskräfte sind angepasst. / Motorized accesses: adapted mast composition, base ballast and reactions. / Acceso a cabina con elevador: Adaptación de composición de mástil, lastre de base y reacciones. / Accessi motorizzati: composizioni elementi torre, zavorre di base e reazioni aggiornate. / Acessos motorizados: composições de coluna, lastro da base e reacções adaptadas. / Лифты : адаптированная композиция мачты, базовый балласт и нагрузки.

□ 1,6 m - P 42A - C50										
ΔΔΔΔ (m)	25	30	35	40	45	50	55	60	65	
(m)	45,2	43,5	43,5	43,5	43,5	43,5	43,5	40,2	40,2	
/P ₊ (m)	45,2	43,5	43,5	43,5	43,5	43,5	43,5	40,2	40,2	
	2 m	1	1	1	1	1	1	1	1	1
	3,33 m	1	2	2	2	2	2	1	1	
	5 m	6	5	5	5	5	5	5	5	
	10 m	1	1	1	1	1	1	1	1	1
F2 (t)	● 143	138	135	138	133	132	133	128	129	
	■ 155	143	149	145	153	155	162	133	140	
F3 (t)	● 112	106	102	104	93	92	91	92	88	
	■ 123	111	116	111	118	120	126	96	103	
(m) D50	45,2	43,5	43,5	43,5	43,5	43,5	41,8	40,2	40,2	
/P ₊ (m) D50	45,2	43,5	43,5	43,5	43,5	43,5	41,8	40,2	40,2	





□ 1,6 m - S 41A - - C50										
ΔΔΔΔ (m)	25	30	35	40	45	50	55	60	65	
(m)	43,3	41,7	41,7	41,7	43,3	43,3	40	38,3	40	
/P ₊ (m)	43,3	41,7	41,7	41,7	43,3	43,3	40	38,3	40	
	2 m	1	1	1	1	1	1	1	1	1
	3,33 m	1	2	2	2	1	1	0	1	0
	5 m	7	6	6	6	7	7	7	6	7
	F1 (t)	● 86	83	83	83	84	83	84	81	85
	■ 86	81	83	82	86	87	82	76	85	
(m) D50	38,3	38,3	38,3	40	40	40	38,3	38,3	38,3	
/P ₊ (m) D50	38,3	38,3	38,3	40	40	40	38,3	38,3	38,3	





□ 1,6 m - ZD 463 - - C50										
ΔΔΔΔ (m)	25	30	35	40	45	50	55	60	65	
(m)	41,2	41,2	39,6	39,6	41,2	41,2	39,6	37,9	37,9	
/P ₊ (m)	41,2	41,2	39,6	39,6	41,2	41,2	39,6	37,9	37,9	
	2 m	1	1	1	1	1	1	1	1	1
	3,33 m	1	1	2	2	1	1	2	0	0
	5 m	7	7	6	6	7	7	6	7	7
	F1 (t)	● 83	83	81	79	81	81	83	80	81
	■ 80	80	75	73	81	81	79	74	76	
(m) D50	41,2	41,2	39,6	39,6	41,2	41,2	39,6	37,9	37,9	
/P ₊ (m) D50	41,2	41,2	39,6	39,6	41,2	41,2	39,6	37,9	37,9	



Ancrages / Verankerungen / Anchorages / Anclajes / Ancoraggi
Ancoragem / нкре







Lest de base / Grundballast / Base ballast / Lastre de base / Zavorra di base
 Lastro da base / Базовый Балласт

 (t) /  1,6 m City -  S 41A -  - C50									
▲▼▲ (m)	25	30	35	40	45	50	55	60	65
43	108	108	108	102	96	96			
41,3	102	102	102	102	96	96	102		102
39,7	102	96	96	96	90	90	96	96	96
34,7	84	84	78	78	72	72	78	78	78
29,7	72	66	66	66	60	60	60	60	60
24,7	66	54	54	54	54	48	48	48	60
19,7	66	54	54	54	54	48	42	48	54

 (t) /  1,6 m City -  ZD 463 -  - C50									
▲▼▲ (m)	25	30	35	40	45	50	55	60	65
40,9	100	100	100	95	90	90			
39,2	95	95	95	90	85	85	90		95
37,6	90	90	90	85	80	80	85	90	85
32,6	75	75	70	70	65	65	70	70	70
27,6	60	60	60	60	50	50	50	55	55
22,6	60	50	50	50	50	45	40	45	55
17,6	60	50	50	50	50	45	40	45	55

 (t) /  1,6 m -  S 41A -  - C50									
▲▼▲ (m)	25	30	35	40	45	50	55	60	65
43,3	114				102	102			
41,7	108	108	108	108	96	96			
40	102	102	102	102	90	90	102		102
38,3	96	96	96	96	90	90	96	96	96
33,3	84	84	78	78	72	72	78	78	78
28,3	72	66	66	66	60	60	60	60	60
23,3	60	60	54	54	54	48	48	48	60
18,3	60	54	48	54	54	48	42	48	60

 (t) /  1,6 m -  ZD 463 -  - C50									
▲▼▲ (m)	25	30	35	40	45	50	55	60	65
41,2	105	105			95	95			
39,6	100	100	100	95	90	90	95		
37,9	95	90	90	90	85	85	90	90	90
32,9	80	75	75	75	70	65	70	75	70
27,9	65	65	60	60	55	55	55	55	55
22,9	60	50	50	50	50	45	40	45	55
17,9	60	50	50	50	50	45	40	45	55

Courbes de charges / Lastkurven / Load curves / Curvas de cargas / Curve di carico / Curvas de carga / Кривые нагрузок



↖ (m)		17	20	22	25	27	30	32	35	37	40	42	45	47	50	52	55	57	60	62	65	m	
↖	↖ 10 t	↖										↖											
↖	↖↔↖ 5 t	↖										↖											
65	3,1 → 19,4	34,6 - 37,4	10	9,6	8,6	7,4	6,8	6	5,5	5	5	4,6	4,4	4	3,8	3,6	3,4	3,2	3	2,85	2,75	2,6	t
	3,1 → 20	36,1 - 39,1	10	9,9	9	7,7	7,1	6,3	5,8	5,2	5	4,9	4,6	4,3	4,1	3,8	3,6	3,4	3,2	3	2,95	2,75	t P+
60	3,1 → 20,3	36,4 - 39,3	10	10	9,1	7,9	7,2	6,3	5,9	5,2	5	4,9	4,6	4,3	4,1	3,8	3,6	3,4	3,2	3			t
	3,1 → 21,1	38,1 - 41,3	10	10	9,5	8,2	7,5	6,7	6,2	5,5	5,2	5	4,9	4,5	4,3	4	3,8	3,6	3,5	3,3			t P+
55	3,1 → 20,6	37,1 - 40	10	10	9,3	8	7,3	6,5	6	5,4	5	5	4,7	4,3	4,1	3,8	3,7	3,4					t
	3,1 → 21,5	39,1 - 42	10	10	9,7	8,4	7,7	6,8	6,3	5,7	5,3	5	5	4,6	4,4	4,1	3,9	3,7					t P+
50	3,1 → 21,5	38,7 - 41,5	10	10	9,7	8,4	7,7	6,8	6,3	5,6	5,3	5	4,9	4,6	4,3	4							t
	3,1 → 22,5	41 - 44	10	10	10	8,9	8,1	7,2	6,7	6	5,6	5,1	5	4,9	4,6	4,3							t P+
45	3,1 → 22,2	39,9 - 43	10	10	10	8,7	8	7	6,5	5,9	5,5	5	5	4,7									t
	3,1 → 23,3	42,5 - 45	10	10	10	9,2	8,5	7,5	7	6,3	5,9	5,4	5,1	5									t P+
40	3,1 → 22,7		10	10	10	8,9	8,2	7,2	6,7	6	5,6	5,1											t
	3,1 → 23,9		10	10	10	9,5	8,7	7,7	7,2	6,5	6,1	5,5											t P+
35	3,1 → 21,7		10	10	9,9	8,5	7,8	6,9	6,4	5,7													t
	3,1 → 23		10	10	10	9,1	8,3	7,4	6,9	6,2													t P+
30	3,1 → 22,1		10	10	10	8,7	8	7															t
	3,1 → 23,5		10	10	10	9,3	8,6	7,6															t P+
25	3,1 → 23		10	10	10	9,1																	t
	3,1 → 24,6		10	10	10	9,8																	t P+

$↖ = ↖ - 0,48 \text{ t max.}$



↖ (m)		17	20	22	25	27	30	32	35	37	40	42	45	47	50	52	55	57	60	62	65	m	
↖	↖ 10 t	↖										↖											
↖	↖↔↖ 5 t	↖										↖											
65	2,4 → 19,5	35 - 35,7	10	9,7	8,7	7,5	6,8	6	5,6	5	4,8	4,3	4,1	3,8	3,6	3,3	3,1	2,9	2,75	2,55	2,45	2,3	t
	2,4 → 20,1	36,5 - 37,3	10	10	9	7,8	7,1	6,3	5,9	5,3	5	4,6	4,3	4	3,8	3,5	3,3	3,1	2,95	2,75	2,65	2,5	t P+
60	2,4 → 20,4	36,7 - 37,5	10	10	9,2	7,9	7,2	6,4	5,9	5,3	5	4,6	4,3	4	3,8	3,5	3,3	3,1	2,95	2,75			t
	2,4 → 21,2	38,6 - 39,3	10	10	9,6	8,3	7,6	6,7	6,2	5,6	5,3	4,9	4,6	4,3	4	3,7	3,6	3,3	3,2	2,95			t P+
55	2,4 → 20,7	37,5 - 38,3	10	10	9,4	8,1	7,4	6,5	6,1	5,4	5,1	4,7	4,5	4,1	3,9	3,6	3,4	3,2					t
	2,4 → 21,6	39,6 - 40,4	10	10	9,8	8,5	7,8	6,9	6,4	5,8	5,4	5	4,8	4,4	4,2	3,9	3,7	3,5					t P+
50	2,4 → 21,6	39,1 - 40	10	10	9,8	8,5	7,7	6,9	6,4	5,7	5,3	5	4,7	4,3	4,1	3,8							t
	2,4 → 22,6	41,5 - 42,3	10	10	10	8,9	8,2	7,3	6,8	6,1	5,7	5,2	5	4,7	4,4	4,1							t P+
45	2,4 → 22,3	40,4 - 41,2	10	10	10	8,8	8	7,1	6,6	5,9	5,6	5,1	4,9	4,5									t
	2,4 → 23,5	43 - 44	10	10	10	9,3	8,6	7,6	7,1	6,4	6	5,5	5,1	4,9									t P+
40	2,4 → 22,8		10	10	10	9	8,3	7,3	6,8	6,1	5,7	5,2											t
	2,4 → 24,1		10	10	10	9,6	8,8	7,8	7,3	6,6	6,1	5,6											t P+
35	2,4 → 21,9		10	10	9,9	8,6	7,9	7	6,4	5,8													t
	2,4 → 23,1		10	10	10	9,2	8,4	7,5	6,9	6,3													t P+
30	2,4 → 22,3		10	10	10	8,8	8	7,1															t
	2,4 → 23,7		10	10	10	9,4	8,6	7,7															t P+
25	2,4 → 23,1		10	10	10	9,2																	t
	2,4 → 24,7		10	10	10	9,9																	t P+



$↖ = ↖ - 0,13 \text{ t max.}$

Poids de flèche & lest de contre-flèche / Auslegergewicht & Gegenauslegerballast / Jib weight & counter-jib ballast / Peso de flecha y lastre de contra-flecha/Peso del braccio & zavorra di contro-braccio/Peso da lança & lastro da contra lança/Вес стрелы и балласт контр-стрелы

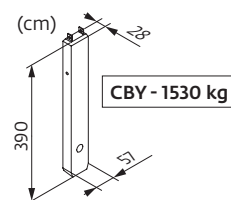
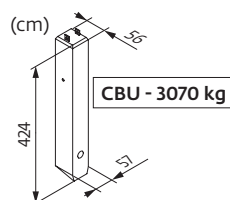
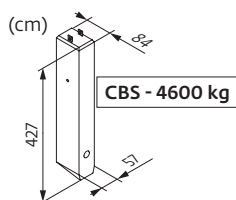







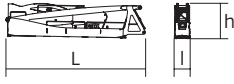
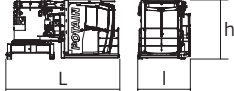
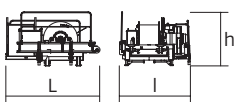
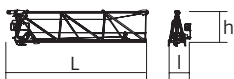
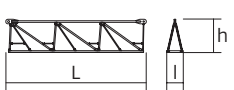
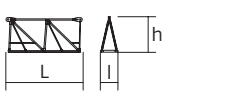
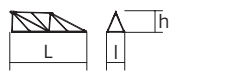
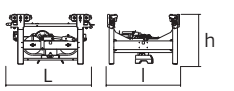

↖	↖ (kg) (+/- 5%)			↖		↖			
	↖↔↖	↖	↖↔↖	4600 kg	1530 kg	↖ (kg)	3070 kg	1530 kg	↖ (kg)
65 m	12460	12185	12550	5	1	24530	7	2	24550
60 m	12235	11960	12330	5	1	24530	7	2	24550
55 m	11855	11610	11925	5	0	23000	7	1	23020
50 m	11010	10765	11080	4	2	21460	6	2	21480
45 m	11155	10905	11225	4	2	21460	6	2	21480
40 m	10340	10095	10415	4	1	19930	6	1	19950
35 m	10220	9975	10295	4	0	18400	5	2	18410
30 m	9270	9025	9340	3	2	16860	5	1	16880
25 m	8740	8495	8810	3	1	15330	4	2	15340

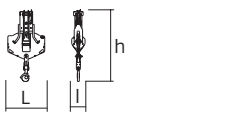

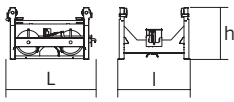

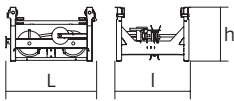

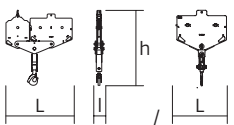
Encombremet et poids / Abmessungen und Gewicht / Dimensions and weight / Dimensiones y peso / Ingombro e peso
 dimensões e pesos / габаритные размеры и вес

Partie tournante / Drehender Kranteil / Slewing crane part / Parte giratoria
 Parte rotante / Parte rotativa / Поворотная часть :  65 m -  -  50 LVF

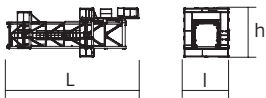

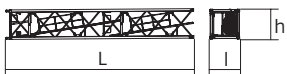
Partie tournante / Drehender Kranteil / Slewing crane part Parte giratoria / Parte rotante / Parte rotativa Поворотная часть		L (m)	l (m)	h (m)	kg (+/- 5%)	
Contre-flèche / Gegenausleger Counter-jib / Contra-flecha Controbrazzo / Contra-lança Контр-стрела		11 11	1,17 1,17	2,47 2,47	8715 8450	
Pivot + cabine / Krankopf + Kabine Towerhead + cab / Pivote + cabina Portaralla + cabina / Pivot + cabina Секция поворотной части + кабина		1,6 m	4,75	2,28 2,52	7880	
Treuil de levage (+ câble) / Hubwerk (+ Seil) Hoisting winch (+ rope) / Mecanismo de elevación (+ cabo) Argano di sollevamento (+ fune) Guincho de elevação (+ cabo) Подъемная лебедка (+ канатом)		50 LVF 75 HPL™	3,24 3,24	2,46 3,29	1,88 1,77	3320 4125
Elément de flèche / Auslegerelement Jib section / Elemento de flecha Elemento di braccio / Elemento de lança Секция стрелы		① 6 DVF	10,83	1,72	2,74	3610
Elément de flèche / Auslegerelement Jib section / Elemento de flecha Elemento di braccio / Elemento de lança Секция стрелы		② ④ ⑤ ⑥	10,31 10,22 10,24 10,19	1,2 1,2 1,2 1,2	2,42 2,39 2,1 1,83	2420 1560 1235 795
Elément de flèche / Auslegerelement Jib section / Elemento de flecha Elemento di braccio / Elemento de lança Секция стрелы		③ ⑦	5,27 5,09	1,2 1,2	2,39 1,53	960 310
Elément de flèche / Auslegerelement Jib section / Elemento de flecha Elemento di braccio / Elemento de lança Секция стрелы		⑧	5,09	1,2	1,39	220
Chariot / Laufkatze Trolley / Carrello Carro / Carro-distribuidor Тележка		 10 t	1,87	1,51	1,05	400
Moufle / Hubflasche Pulley block / Aparejo Bozzello / Cadernal Полиспаст		 10 t	1,02	0,43	2	315
Chariot / Laufkatze Trolley / Carrello Carro / Carro-distribuidor Тележка		 10 t	1,57	1,51	0,98	210
Chariot / Laufkatze Trolley / Carrello Carro / Carro-distribuidor Тележка		 10 t  5 t	1,7 1,86	1,51 1,51	1,03 0,98	245 236
Moufle / Hubflasche Pulley block / Aparejo Bozzello / Cadernal Полиспаст		 10 t  5 t	1,65 1,09	0,22 0,16	1,71 1,49	325 195

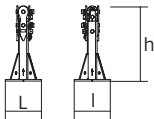
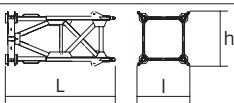
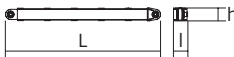
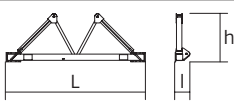
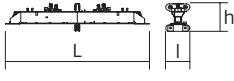
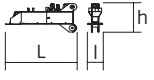
Рyбoнe / Kranturm / Crane tower Mástil / Torre / Torre Башня крана		L (m)	l (m)	h (m)	kg (+/- 5%)	
T 41		10,85	3,73	4,1	7100	
K40/K40-2		2,21	2,1	2,06	1330	
K 447E KM 447E KM 449E		10,21 10,21 10,21	1,62 1,62 1,62	1,62 1,62 1,62	3390 3215 4005	
K 447A KMT 447A K 449A KMT 449A		5,21 5,21 5,21 5,21	1,67 1,67 1,67 1,67	1,62 1,62 1,62 1,62	1850 1745 2230 2130	
K 447C KMT 447C		3,45 3,54	1,67 1,67	1,62 1,62	1360 1350	
Pieds de scellement / VerankerungsfüÙe Fixing angles / Pie de empotramiento Montante da anegare / Angulos fixadores анкера		P 24A / P 42A	0,56	0,56	1,17	240
Mât-châssis / Grundmasteinheit Basic mast unit / Tramo-chasis Elemento base / Tramo-chassis Mачта для крепления к шасси		S 41A	3,63	1,96	2,08	3235
Haubans / Mastabstützungen Struts / Tornapuntas Puntoni / Escoras Растяжка		S 41A	3,18	0,26	0,24	370
Sommier / Unterwagenhälfte Half-bearer / Testero Testata / Estrutura base Траверса		S 41A	5,1	0,6	1,78	1050
Bras de croix / Fundamentkreuzträger Cross girder / Braço en cruz Braccio croce / Braço da cruz Поперечная балка		ZD 463	7,65	1,17	1,36	3585
1/2 Bras de croix / 1/2 Fundamentkreuzträger 1/2 Cross girder / 1/2 Braço en cruz 1/2 Braccio croce / 1/2 Braço da cruz 1/2 Поперечная балка		ZD 463	3,41	0,7	1,35	1655

Mécanismes / Triebwerke / Mechanisms / Mecanismos / Meccanismi
 Механизмы / Механизмы

400 V - 50 Hz										ch - PS hp	kW				
	50 LVF 25 Optima	m/min	38,5	50,5	67,5	95,5	20	26	35	48	50	37	557 m		
		t	5	3,75	2,5	1	10	7,5	5	2,3					
	75 HPL™ 25	m/min	54,5	71	102,5	157,5	215,5	28	37	54	82	107,5	75	55	834 m
		t	5	3,75	2,5	1,25	0,4	10	7,5	5	2,5	1,2			
	6 DVF 4 Optima	m/min	0 → 50 (10 t) 0 → 100 (6 t) 0 → 120 (3 t)								5,5	4			
	RVF 162 Optima+	tr/min U/min rpm	0 → 0,8								2 x 7,5	2 x 5,5			

50 LVF 25 Optima

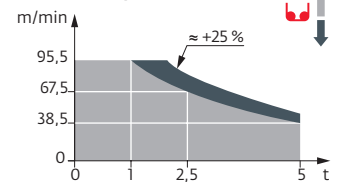

IEC 60204-32	
400 V (+10% -10%) 50 Hz	50 LVF : 58 → 38 kVA 75 HPL™ : 78 → 48 kVA

	FR	DE	EN	ES	IT	PT	RU
	Profil de vent suivant EN 14439 C50-D50	Windbedingungen gemäss EN 14439 C50-D50	Wind conditions according to EN 14439 C50-D50	Conformidad de los condiciones de viento EN 14439 C50-D50	Condizioni del vento secondo EN 14439 C50-D50	Perfil de vento conforme EN 14439 C50-D50	Ветровой режим в соответствии с EN 14439 C50-D50
	Appel de flèche	Auslegerüberhöhung	Jib elevation	Elevación de la flecha	Inclinazione braccio	Desvio da lança	подъем стрелы
	Équipements standards	Standardausrüstungen	Standard equipment	Equipamiento de serie	Equipaggiamento standard	Equipamento de série	Стандартное оборудование
	Équipements optionnels	Sonderausrüstungen	Options	Equipamiento opcional	Equipaggiamento in opzione	Equipamento opcional	Дополнительное оборудование (опция)
	Fonction Potain Plus : Courbes de charges Plus	Funktion Potain Plus: Plus-Lastkurven	Potain Plus function: Plus load curves	Funzione Potain Plus: Diagrama de cargas Plus	Funzione Potain Plus: Curve di carico Plus	Função Potain Plus: Diagrama de cargas Plus	Функция контроля мощности Potain Plus: Диаграммы грузоподъемности Plus
	Hauteurs sous crochet associées aux courbes de charges Plus	Hakenhöhen mit Plus-Lastkurven	Hook heights with Plus load curves	Altura bajo gancho, usando el diagrama de cargas Plus	Altezze sotto gancio con curve di carico Plus	Altura livre, utilizando o diagrama de cargas Plus	Высота под крюком для диаграмм грузоподъемности Plus
	Réactions en service	Reaktionskräfte in Betrieb	Reactions in service	Reacciones en servicio	Reazioni in servizio	Reações em serviço	Реакция при работе
	Réactions hors service	Reaktionskräfte außer Betrieb	Reactions out of service	Reacciones fuera de servicio	Reazioni fuori servizio	Reações fora de serviço	Реакция в покое
	Poids total du lest	Ballast-Gesamtgewicht	Total ballast weight	Peso total del lastre	Peso totale della zavorra	Peso total do lastro	Общий вес балласта
	Poids de flèche	Auslegergewicht	Jib weight	Peso de flecha	Peso del braccio	Peso da lança	вес стрелы
	Camion 13,4 m	Lkw 13,4 m	Lorry 13,4 m	Camión 13,4 m	Camion 13,4 m	Camião 13,4 m	Рзусовой автомобиль 13,4 м
	Conteneur High Cube 40', et/ou Flat Rack 20'	Container High Cube 40', und/oder Flat Rack 20'	Container High Cube 40', and/or Flat Rack 20'	Contenedor High Cube 40', y/o Flat Rack 20'	Container High Cube 40', e/o Flat Rack 20'	Contentor High Cube 40', e/ou Flat Rack 20'	40-футовый контейнер повышенной вместимости High Cube, и/или 20-футовая открытая платформа Flat Rack
	Levage	Heben	Hoisting	Elevación	Sollevamento	Elevação	Подъем
	Distribution	Katzfahren	Trolleying	Distribución	Distribuzione	Distribuição	Перемещение по стреле
	Orientation	Schwenken	Slewing	Orientación	Rotazione	Rotação	Поворот
	Translation	Kranfahren	Travelling	Traslación	Traslazione	Translação	Перемещение крана
	Puissance requise	Erforderliche Leistung	Required power	Potencia Necesaria	Potenza richiesta	Potência Necessária	Потребляемая мощность
	Fonction Power Control : vitesses treuils adaptées à la puissance disponible	Funktion Power Control: Geschwindigkeiten der Triebwerke werden an die verfügbare Leistung angepasst	Power Control Function: winch speeds adapted to the available power	Función Power Control: marchas de los cabrestantes adaptadas a la potencia disponible	Funzione Power Control: velocità degli argani adattate alla potenza disponibile	Função Power Control: velocidades de guincho adaptadas à potência disponível	Функция контроля мощности Power Control: регулировка скорости лебедок в зависимости от доступной мощности
	Nous consulter	Auf Anfrage	Consult us	Consultarnos	Consultateci	Consultar-nos	Проконсультируйтесь у нас
	Document commercial non contractuel. Pour toute information technique se référer à la notice correspondante.	Unverbindliches Vertriebsdokument. Für technische Informationen, siehe die entsprechenden Anweisungen.	This commercial document is not legally binding. For any technical information, please refer to the corresponding instructions.	Documento comercial no contractual. Para cualquier información técnica, ver la noticia correspondiente.	Documento commerciale non vincolante, per tutte le informazioni tecniche fare riferimento al catalogo istruzioni.	Documento comercial não contractual. Para qualquer informação técnica complementar consultar as respectivas instruções.	Этот коммерческий документ не является юридически обязательным. Для получения технической информации, см. соответствующие инструкции.

