

## MDT 189

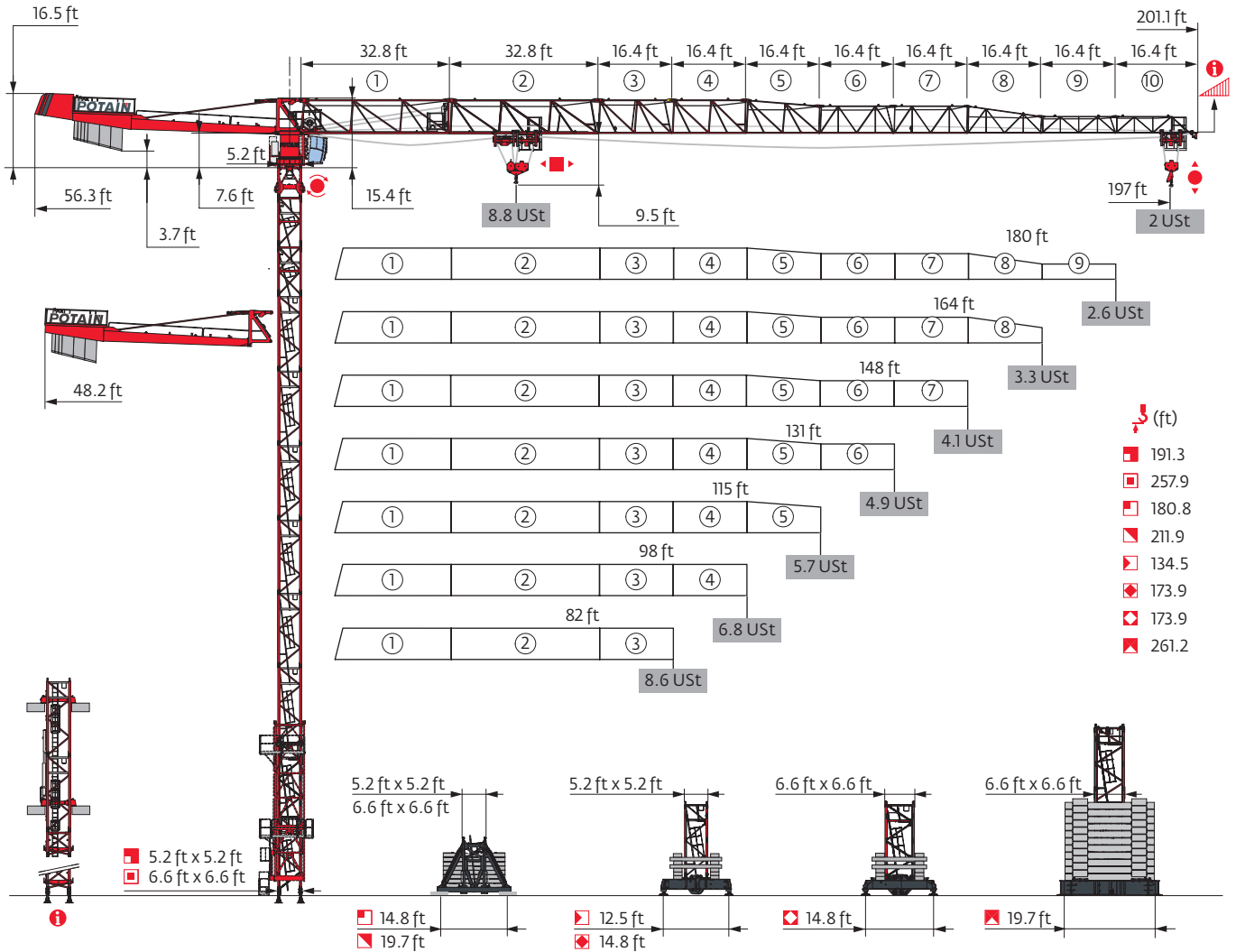

Potain Plus



Power Control

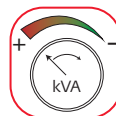

Top Site



Top Tracing 3

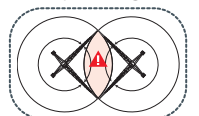

Mast - Reactions

**5.2 ft City - P 42A**

Height (ft)	82	98	115	131	148	164	180	197
Height (ft)	185.7	191.3	185.7	180.1	180.1	174.9	169.3	169.3
Height/P <sub>r</sub> (ft)	185.7	191.3	185.7	180.1	180.1	174.9	169.3	169.3
10.9 ft	2	1	2	0	0	1	2	2
16.4 ft	8	9	8	9	9	8	7	7
32.8 ft	1	1	1	1	1	1	1	1
F2 (USt)	● 145 ■ 201	148 215	144 206	141 190	144 192	145 189	138 178	140 185
F3 (USt)	● 111 ■ 171	113 185	109 175	106 160	108 160	109 157	103 147	104 154

**5.2 ft City - ZC 4230 - ZD 4230**

Height (ft)	82	98	115	131	148	164	180	197
Height (ft)	134.5	134.5	134.5	134.5	134.5	129.3	129.3	129.3
Height/P <sub>r</sub> (ft)	123.7	129.3	129.3	123.7	123.7	123.7	129.3	123.7
10.9 ft	0	0	0	0	0	1	1	1
16.4 ft	8	8	8	8	8	7	7	7
F1 (USt)	● 77 ■ 67	75 67	75 68	76 68	78 70	78 70	79 70	79 73

**5.2 ft City - ZD 4230 - S 41A**

Height (ft)	82	98	115	131	148	164	180	197
Height (ft)	150.9	156.5	156.5	150.9	145.7	145.7	145.7	145.7
Height/P <sub>r</sub> (ft)	150.9	156.5	156.5	150.9	145.7	145.7	145.7	145.7
10.9 ft	0	2	2	0	1	1	1	1
16.4 ft	9	8	8	8	9	8	8	8
F1 (USt)	● 74 ■ 68	75 76	75 76	76 76	75 71	75 71	74 71	75 73

**5.2 ft - P 42A**

Height (ft)	82	98	115	131	148	164	180	197
Height (ft)	181.4	186.7	181.4	175.9	175.9	170.3	170.3	170.3
Height/P <sub>r</sub> (ft)	181.4	186.7	181.4	175.9	175.9	170.3	170.3	170.3
6.6 ft	1	1	1	1	1	1	1	1
10.9 ft	1	0	1	2	2	0	0	0
16.4 ft	8	9	8	7	7	8	8	8
32.8 ft	1	1	1	1	1	1	1	1
F2 (USt)	● 145 ■ 206	148 221	144 211	143 202	145 203	144 194	142 193	143 199
F3 (USt)	● 111 ■ 177	113 190	109 181	108 171	109 171	109 163	106 161	108 168

**5.2 ft - S 41A - ZD 463**

Height (ft)	82	98	115	131	148	164	180	197
Height (ft)	180.8	180.8	180.8	175.5	170	164.4	164.4	164.4
Height/P <sub>r</sub> (ft)	180.8	180.8	180.8	175.5	170	164.4	164.4	164.4
6.6 ft	1	1	1	1	1	1	1	1
10.9 ft	0	0	0	1	2	0	0	0
16.4 ft	10	10	10	9	8	9	9	9
F1 (USt)	● 90 ■ 109	90 112	90 112	88 106	86 101	85 96	86 95	87 100

**5.2 ft - ZD 463 - ZD 463**

Height (ft)	82	98	115	131	148	164	180	197
Height (ft)	173.9	173.9	173.9	168.6	168.6	157.5	157.5	157.5
Height/P <sub>r</sub> (ft)	173.9	173.9	173.9	168.6	168.6	157.5	157.5	157.5
6.6 ft	1	1	1	1	1	1	1	1
10.9 ft	0	0	0	1	1	0	0	0
16.4 ft	10	10	10	9	9	9	9	9
F1 (USt)	● 85 ■ 101	85 104	85 104	84 98	86 99	83 89	82 88	82 92

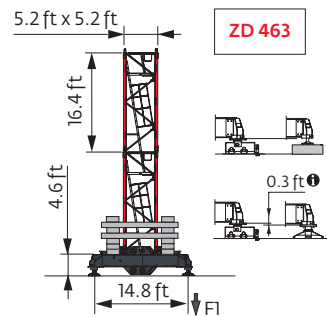
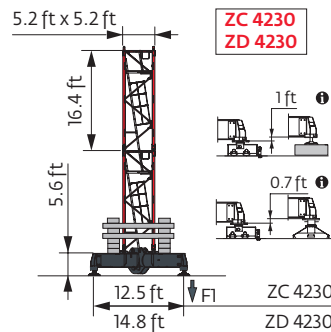
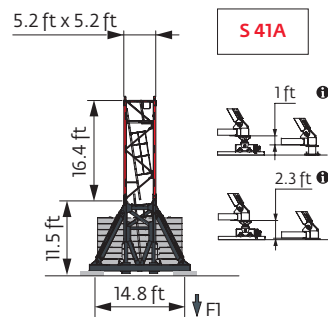
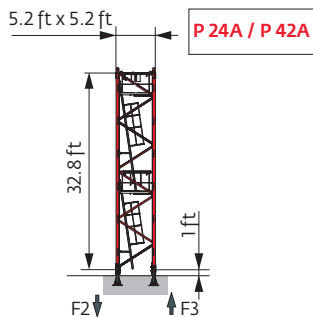

**6.6 ft - P 63A**

Height (ft)	82	98	115	131	148	164	180	197
$H$ (ft)	257.9	257.9	257.9	257.9	257.9	252.3	252.3	252.3
$H/P_+$ (ft)	257.9	257.9	257.9	257.9	257.9	252.3	252.3	252.3
6.6 ft	1	1	1	1	1	1	1	1
10.9 ft	2	2	2	2	2	0	0	0
16.4 ft	12	12	12	12	12	13	13	13
32.8 ft	1	1	1	1	1	1	1	1
F2 (Ust)	● 182	182	181	184	186	187	186	188
	■ 387	390	391	392	393	380	380	385
F3 (Ust)	● 138	137	136	137	139	140	139	140
	■ 347	350	350	350	350	338	337	342

**6.6 ft - V 60A**

Height (ft)	82	98	115	131	148	164	180	197
$H$ (ft)	211.9	211.9	211.9	211.9	211.9	211.9	211.9	211.9
$H/P_+$ (ft)	211.9	211.9	211.9	211.9	211.9	211.9	211.9	211.9
6.6 ft	1	1	1	1	1	1	1	1
10.9 ft	1	1	1	1	1	1	1	1
16.4 ft	11	11	11	11	11	11	11	11
F1 (Ust)	● 97	97	97	98	99	101	101	101
	■ 138	140	140	140	141	144	143	147

**6.6 ft - ZD 463**

Height (ft)	82	98	115	131	148	164	180	197
$H$ (ft)	173.9	173.9	173.9	173.9	173.9	173.9	173.9	173.9
$H/P_+$ (ft)	173.9	173.9	173.9	173.9	173.9	173.9	173.9	173.9
6.6 ft	1	1	1	1	1	1	1	1
10.9 ft	0	0	0	0	0	0	0	0
16.4 ft	10	10	10	10	10	10	10	10
F1 (Ust)	● 95	97	97	96	97	100	99	101
	■ 124	127	127	127	127	132	131	136

**6.6 ft - ZX 640**

Height (ft)	82	98	115	131	148	164	180	197
$H$ (ft)	261.2	261.2	261.2	261.2	261.2	255.6	255.6	255.6
$H/P_+$ (ft)	261.2	261.2	261.2	261.2	261.2	255.6	255.6	255.6
6.6 ft	1	1	1	1	1	1	1	1
10.9 ft	2	2	2	2	2	0	0	0
16.4 ft	12	12	12	12	12	13	13	13
32.8 ft	1	1	1	1	1	1	1	1
F1 (Ust)	● 137	137	137	138	139	137	137	137
	■ 211	213	214	214	214	207	207	210

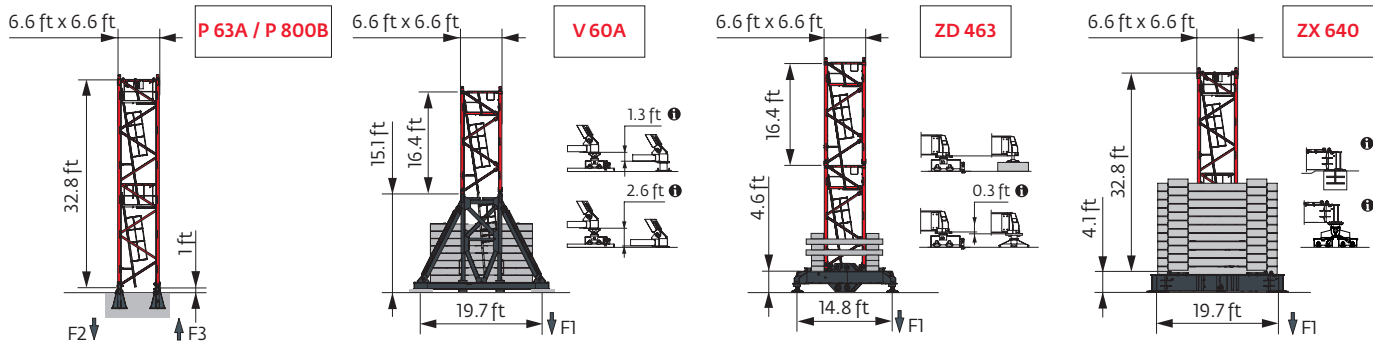

Note: When "ASCE" is noted in this data sheet it is referring to 115 mph Wind Zone, Exposure B, Design Wind Speed = 98 mph. See back cover for design wind speed calculations.

**i** Motorized accesses: adapted mast compositions, base ballast and reactions.

Other mast compositions - Please consult us

Anchorage

**i**

Base ballast

**Ust) / 5.2 ft City - ZC 4230 -**

ft)	82	98	115	131	148	164	180	197
134.5	99.2	93.7	93.7	93.7	99.2			
129.3	93.7	99.2	99.2	88.2	93.7	99.2	99.2	99.2
112.9	93.7	93.7	88.2	88.2	88.2	88.2	82.7	77.2
96.5	93.7	93.7	88.2	88.2	82.7	77.2	77.2	77.2
80.1	93.7	93.7	88.2	88.2	82.7	77.2	77.2	77.2
64	93.7	93.7	88.2	88.2	82.7	77.2	77.2	77.2

**Ust) / 5.2 ft - S 41A -**

ft)	82	98	115	131	148	164	180	197
180.8	119.1	119.1	119.1					
175.5	112.4	112.4	112.4	112.4				
170	105.8	105.8	105.8	105.8	105.8			
164.4	99.2	99.2	99.2	99.2	99.2	105.8	112.4	112.4
148	86	86	86	86	86	92.6	92.6	92.6
131.6	79.4	79.4	72.8	72.8	72.8	79.4	79.4	79.4
115.2	72.8	72.8	66.1	66.1	66.1	59.5	66.1	59.5
98.8	66.1	66.1	66.1	66.1	59.5	52.9	46.3	46.3
82.4	66.1	66.1	66.1	66.1	59.5	52.9	46.3	46.3
66	66.1	66.1	66.1	66.1	59.5	52.9	46.3	46.3

**Ust) / 6.6 ft - V 60A -**

ft)	82	98	115	131	148	164	180	197
211.9	145.5	145.5	145.5	145.5	145.5	145.5	145.5	145.5
195.5	119.1	119.1	119.1	119.1	119.1	119.1	119.1	119.1
179.1	92.6	92.6	92.6	92.6	92.6	92.6	92.6	92.6
162.7	66.1	66.1	66.1	66.1	66.1	66.1	66.1	66.1
146.3	52.9	52.9	52.9	52.9	52.9	52.9	52.9	52.9
129.9	39.7	39.7	39.7	39.7	39.7	39.7	39.7	39.7
113.5	39.7	39.7	39.7	26.5	26.5	26.5	26.5	26.5
97.1	39.7	39.7	39.7	26.5	26.5	26.5	26.5	26.5
80.7	39.7	39.7	39.7	26.5	26.5	26.5	26.5	26.5
64.3	39.7	39.7	39.7	26.5	26.5	26.5	26.5	26.5

**Ust) / 6.6 ft - ZD 463 -**

ft)	82	98	115	131	148	164	180	197
173.9	126.8	132.3	132.3	126.8	126.8	132.3	132.3	137.8
157.5	93.7	93.7	93.7	93.7	93.7	99.2	99.2	99.2
141.1	77.2	77.2	71.7	77.2	77.2	82.7	82.7	82.7
124.7	66.1	60.6	60.6	60.6	60.6	66.1	66.1	66.1
108.3	60.6	60.6	60.6	60.6	55.1	49.6	49.6	49.6
91.9	60.6	60.6	60.6	60.6	55.1	49.6	38.6	38.6
75.5	60.6	60.6	60.6	60.6	55.1	49.6	38.6	38.6
59.1	60.6	60.6	60.6	60.6	55.1	49.6	38.6	38.6

**Ust) / 5.2 ft City - ZD 4230 -**

ft)	82	98	115	131	148	164	180	197
156.5		88.2	88.2	88.2				
150.9	88.2	82.7	82.7	82.7	88.2			
145.7	88.2	82.7	82.7	82.7	82.7	88.2	88.2	88.2
129.3	77.2	77.2	71.7	71.7	71.7	71.7	71.7	71.7
112.9	71.7	71.7	71.7	71.7	66.1	60.6	60.6	55.1
96.5	71.7	71.7	71.7	71.7	66.1	60.6	49.6	49.6
80.1	71.7	71.7	71.7	71.7	66.1	60.6	49.6	49.6
63.7	71.7	71.7	71.7	71.7	66.1	60.6	49.6	49.6

**Ust) / 5.2 ft - ZD 463 -**

ft)	82	98	115	131	148	164	180	197
173.9	104.7	104.7	104.7					
168.6	99.2	99.2	99.2	99.2	104.7			
157.5	93.7	88.2	88.2	88.2	93.7	99.2	99.2	99.2
141.1	77.2	77.2	77.2	77.2	77.2	82.7	82.7	82.7
124.7	71.7	71.7	66.1	66.1	66.1	66.1	66.1	66.1
108.3	66.1	66.1	60.6	60.6	60.6	55.1	55.1	49.6
91.9	66.1	66.1	60.6	60.6	55.1	49.6	38.6	38.6
75.5	66.1	66.1	60.6	60.6	55.1	49.6	38.6	38.6
59.1	66.1	66.1	60.6	60.6	55.1	49.6	38.6	38.6

**Ust) / 6.6 ft - ZX 640 -**

ft)	82	98	115	131	148	164	180	197
261.2	242.5	242.5	242.5	242.5	242.5			
255.6	220.5	231.5	231.5	231.5	231.5	231.5	231.5	231.5
239.2	187.4	187.4	187.4	187.4	187.4	187.4	187.4	198.4
222.8	154.3	154.3	154.3	154.3	154.3	154.3	154.3	165.4
206.4	121.3	132.3	121.3	121.3	121.3	132.3	121.3	132.3
190	99.2	99.2	99.2	99.2	99.2	99.2	99.2	99.2
173.6	66.1	77.2	66.1	66.1	66.1	77.2	77.2	77.2
157.2	55.1	55.1	55.1	55.1	55.1	55.1	66.1	66.1
140.8	44.1	44.1	44.1	44.1	44.1	44.1	44.1	44.1
124.3	33.1	33.1	33.1	33.1	33.1	33.1	33.1	33.1
107.9	33.1	33.1	33.1	33.1	22.1	22.1	22.1	22.1
58.7	33.1	33.1	33.1	33.1	22.1	22.1	22.1	22.1

Load curves



(ft)			56	66	72	82	89	98	105	115	121	131	138	148	154	164	171	180	187	197	ft	
	8.8 USt	4.4 USt																				
197	9 → 63	106 - 113	8.8	8.4	7.5	6.4	5.7	4.9	4.5	4.3	4	3.6	3.4	3.1	2.85	2.6	2.4	2.2	2.05	1.9	USt	
	9 → 65	106 - 115	8.8	8.6	7.7	6.4	5.7	4.9	4.5	4.4	4.1	3.7	3.5	3.2	3	2.75	2.55	2.35	2.15	2	USt <b>P+</b>	
180	9 → 68	113 - 121	8.8	8.8	8.2	7	6.2	5.4	4.9	4.4	4.4	4	3.7	3.4	3.2	2.85	2.7	2.45	USt			
	9 → 68	113 - 122	8.8	8.8	8.2	7	6.2	5.4	4.9	4.4	4.4	4	3.8	3.5	3.3	3	2.8	2.6	USt <b>P+</b>			
164	9 → 66	120 - 129	8.8	8.8	8	7	6.4	5.6	5.2	4.7	4.4	4.3	4	3.7	3.5	3.2	USt					
	9 → 72	120 - 131	8.8	8.8	8.6	7.5	6.8	5.9	5.3	4.7	4.4	4.4	4.1	3.8	3.6	3.3	USt <b>P+</b>					
148	9 → 71	128 - 138	8.8	8.8	8.6	7.4	6.8	6	5.6	5	4.7	4.4	4.4	4	USt							
	9 → 77	129 - 139	8.8	8.8	8.8	8.1	7.4	6.4	5.8	5.2	4.8	4.4	4.4	4.1	USt <b>P+</b>							
131	9 → 71	129 - 131	8.8	8.8	8.6	7.5	6.9	6.1	5.6	5.1	4.7	4.4	USt									
	9 → 77		8.8	8.8	8.8	8.2	7.5	6.6	6.2	5.6	5.2	4.8	USt <b>P+</b>									
115	9 → 71		8.8	8.8	8.6	7.5	6.9	6.1	5.6	5.1	USt											
	9 → 76		8.8	8.8	8.8	8.1	7.5	6.6	6.1	5.5	USt <b>P+</b>											
98	9 → 71		8.8	8.8	8.6	7.5	6.9	6.1	USt													
	9 → 76		8.8	8.8	8.8	8.1	7.5	6.6	USt <b>P+</b>													
82	9 → 75		8.8	8.8	8.8	8	USt															
	9 → 79		8.8	8.8	8.8	8.5	USt <b>P+</b>															

$$W_{1.4} = W_{1.3} - 0.54 \text{ USt max.}$$



(ft)			56	66	72	82	89	98	105	115	121	131	138	148	154	164	171	180	187	197	ft	
	8.8 USt	4.4 USt																				
197	7 → 64	109 - 109	8.8	8.6	7.7	6.6	5.9	5.1	4.6	4.1	3.9	3.5	3.2	2.9	2.7	2.45	2.25	2.05	1.9	1.7	USt	
	7 → 66	110 - 110	8.8	8.8	7.8	6.6	5.9	5.1	4.7	4.2	3.9	3.6	3.3	3	2.85	2.55	2.4	2.15	2	1.85	USt <b>P+</b>	
180	7 → 69	116 - 116	8.8	8.8	8.3	7.1	6.4	5.6	5.1	4.5	4.2	3.8	3.5	3.2	3	2.7	2.5	2.3	USt			
	7 → 70	117 - 118	8.8	8.8	8.4	7.1	6.4	5.6	5.1	4.5	4.3	3.9	3.6	3.3	3.1	2.85	2.65	2.4	USt <b>P+</b>			
164	7 → 68	123 - 125	8.8	8.8	8.2	7.1	6.6	5.8	5.4	4.9	4.5	4.1	3.9	3.5	3.3	3	USt					
	7 → 73	124 - 126	8.8	8.8	8.8	7.7	7	6.1	5.5	4.9	4.5	4.2	3.9	3.6	3.4	3.2	USt <b>P+</b>					
148	7 → 72	132 - 135	8.8	8.8	8.8	7.6	7	6.2	5.8	5.2	4.9	4.4	4.2	3.9	USt							
	7 → 78	133 - 135	8.8	8.8	8.8	8.3	7.6	6.6	6	5.3	5	4.5	4.3	4	USt <b>P+</b>							
131	7 → 72		8.8	8.8	8.8	7.7	7	6.3	5.8	5.3	4.9	4.5	USt									
	7 → 78		8.8	8.8	8.8	8.3	7.7	6.8	6.3	5.7	5.4	4.9	USt <b>P+</b>									
115	7 → 72		8.8	8.8	8.8	7.7	7	6.3	5.8	5.3	USt											
	7 → 78		8.8	8.8	8.8	8.3	7.6	6.8	6.3	5.7	USt <b>P+</b>											
98	7 → 73		8.8	8.8	8.8	7.7	7.1	6.3	USt													
	7 → 78		8.8	8.8	8.8	8.3	7.6	6.8	USt <b>P+</b>													
82	7 → 76		8.8	8.8	8.8	8.1	USt															
	7 → 81		8.8	8.8	8.8	8.6	USt <b>P+</b>															

$$W_{1.4} = W_{1.3} - 0.2 \text{ USt max.}$$

Jib weight & counter-jib ballast

ft	(lb) - 33 LVF (+/- 5%)					Σ (lb)
				7,937 lb	2,425 lb	
197 ft	19,687	19,290	20,040	3	4	33,510
180 ft	19,257	18,861	19,610	3	4	33,510
164 ft	18,750	18,354	19,103	3	3	31,085
148 ft	18,100	17,703	18,453	3	3	31,085
131 ft	17,350	16,954	17,703	3	2	28,660
115 ft	16,535	16,138	16,887	3	1	26,235
98 ft	15,734	15,338	16,087	3	0	23,810
82 ft	14,912	14,515	15,265	2	3	23,149

CAU - 7,937 lb

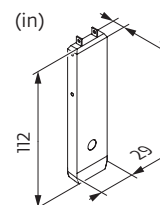
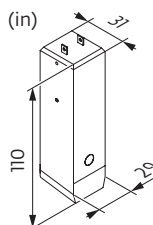

CAV - 2,425 lb







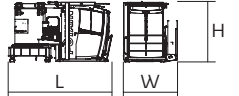

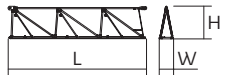
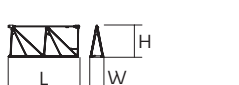
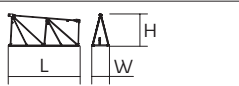
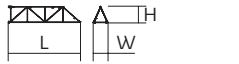
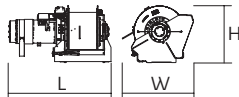
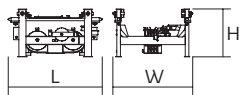
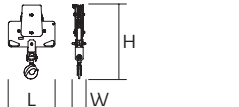
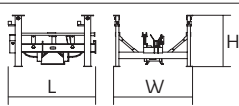
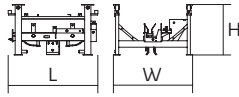
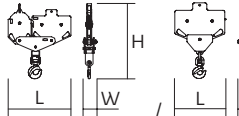
Dimensions and weight

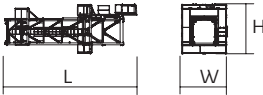
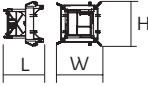
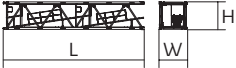
Slewing crane part:  197 ft -  33 LVF

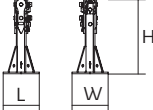
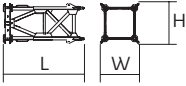
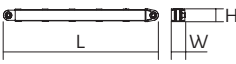
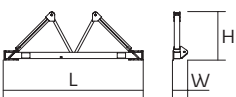
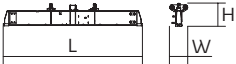
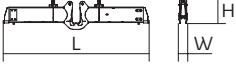

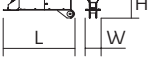
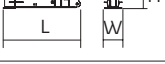
Slewing crane part		L (ft)	W (ft)	H (ft)	lb (+/- 5%)
Counter-jib		38.9	4.4	8.2	11,023
Towerhead + cab	 Ultra View	14.2	7.4	8.1	13,338
Jib section	 ① 33 LVF 6 DVF	36	9.6	8.6	8,400
Jib section	 ②	33.6	3.4	7.8	3,217
Jib section	 ③ ④ ⑥ ⑦ ⑨	17.1 17 17 17 16.9	3.4 3.4 3.4 3.4 3.4	7.7 7.6 6.3 6.2 3.9	1,336 1,283 886 756 503
Jib section	 ⑤ ⑧	17 16.9	3.4 3.4	7.6 6.2	990 646
Jib section	 ⑩	16.7	3.4	3.8	417
Hoisting winch (+ rope)	 33 LVF 50 LVF 50 LVF GH	4.5 5 5.3	2.7 3.1 4.4	2.5 3 4.1	2,006 2,646 4,288
Trolley	 8.8 USt	5.2	4.4	2.9	617
Pulley block	 8.8 USt	3	0.8	4.6	617
Trolley	 8.8 USt	4.6	4.1	3.1	617
Trolley	 8.8 USt 4.4 USt	4.7 5	4.1 4.3	3.1 3.1	617 518
Pulley block	 8.8 USt 4.4 USt	4.1 2.6	0.9 0.6	5 4.5	551 287

Crane tower			L (ft)	W (ft)	H (ft)	lb (+/- 5%)
Telescopic cage T41 Telescopic cage T61		□ 5.2 ft □ 6.6 ft	35.6 35.5	12.3 13.6	13.5 14.7	15,653 21,385
K40/K40-2 K60/K40-2		□ 5.2 ft □ 6.6/5.2 ft	7.3 7.3	6.9 8.2	6.8 8.1	2,932 5,820
K 447E KM 447E KM 449E K 649B KM 649E KRM 6410B		□ 5.2 ft □ 5.2 ft □ 5.2 ft □ 6.6 ft □ 6.6 ft □ 6.6 ft	33.5 33.5 33.5 33.6 33.8 33.6	5.3 5.3 5.3 6.8 6.7 6.9	5.3 5.3 5.3 6.7 6.7 6.8	7,474 7,088 8,830 11,663 10,692 15,653
K 447A KMT 447A K 449A KMT 449A KR 649A KRMT 649A K 649A KMT 649A		□ 5.2 ft □ 5.2 ft □ 5.2 ft □ 5.2 ft □ 6.6 ft □ 6.6 ft □ 6.6 ft □ 6.6 ft	17.1 17.1 17.1 17.1 17.2 17.2 17.2 17.2	5.5 5.5 5.5 5.5 6.9 6.9 6.8 6.8	5.3 5.3 5.3 5.3 6.8 6.8 6.7 6.7	4,079 3,847 4,916 4,696 7,165 6,724 6,184 5,666
K 447C KMT 447C K 649C KMT 649C KRMT 649C		□ 5.2 ft □ 5.2 ft □ 6.6 ft □ 6.6 ft □ 6.6 ft	11.3 11.6 11.7 11.7 11.7	5.5 5.5 6.8 6.8 6.9	5.3 5.3 6.7 6.7 6.8	2,998 2,976 4,376 4,542 5,401
Fixing angles		P 24A / P 42A P 63A / P 800B	1.8 2.5	1.8 2.5	3.8 4.2	529 1,025
Basic mast unit		S 41A V 60A	11.9 16.4	6.4 7.9	6.8 7.9	7,132 10,494
Struts		S 41A V 60A	10.4 14.8	0.9 1	0.8 1	816 1,036
Half-bearer		S 41A V 60A	16.7 22	2 2.3	5.8 7.6	2,315 4,057
Cross girder		ZC 4230 ZD 4230	18.5 21.8	2.7 2.7	3.4 3.4	3,505 4,035
Cross girder		ZC 4230 ZD 4230	18.5 21.8	1.5 1.5	4.4 4.4	4,178 4,707
Cross girder		ZD 463	25.1	3.8	4.5	7,904
1/2 Cross girder		ZD 463	11.2	2.3	4.4	3,649
1/2 Cross girder		ZX 640	14.3	3.3	5.1	7,319
Cross girder		ZX 640	30	3.9	5.1	15,168

Mechanisms

480 V - 60 Hz											hp	kW	
	33 LVF 20 Optima	fpm	89	118	167	240	46	59	89	121	33	22	951 ft
		USt	4.4	3.3	2.2	0.9	8.8	6.6	4.4	2			
	50 LVF 20 Optima	fpm	157	203	285	397	82	108	151	200	50	37	1,191 ft
		USt	4.4	3.3	2.2	1.2	8.8	6.6	4.4	2.8			
50 LVF 20 GH Optima	fpm	161	210	289	371	82	105	151	187	50	37	2,080 ft	
	USt	4.4	3.3	2.2	1.2	8.8	6.6	4.4	2.9				
	6 DVF 4 Optima	fpm	0 → 262 (8.8 USt) 0 → 328 (2.2 USt)							5.5	4		
	RVF 152 Optima+	rpm	0 → 0.8							2 x 5.5	2 x 4		

480 V (+6% -10%) 60 Hz	33 LVF: 41 → 28 kVA 50 LVF / 50 LVF GH: 54 → 34 kVA	

33 LVF 20 Optima

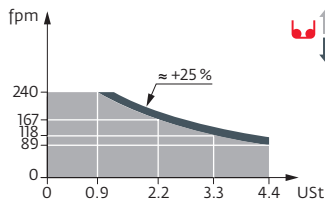

50 LVF 20 Optima

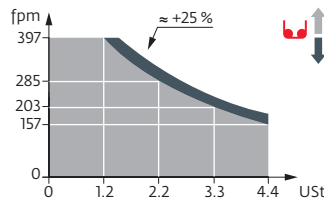

50 LVF 20 GH Optima

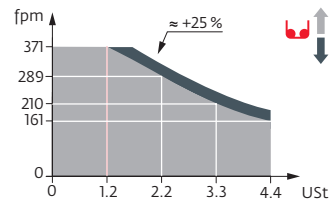

These mast combinations meet the EN 14439 and ASME B30.3-2016 specifications for "out of service" wind conditions, provided the illustrated wind speed matches required design wind speed for the location of the tower crane. The "out of service" design wind speed was determined in accordance with ASCE 7-10, Figure 26.5-1A. The wind velocity, used for this configuration was 98 mph (158 kph), which represents a nominal design 3-second wind gust at 33 ft (10 m) above ground for Exposure B category. A factor of 0.85 was applied to the 700-year ultimate design wind speed of 115 mph (185 kph), per ASCE 37-02, with the assumption that this crane is considered a temporary structure used during a construction period of 2 years or less.

- Jib elevation
- Total ballast weight
- Travelling
- Standard equipment
- Jib weight
- Required power
- Options
- Lorry 44 ft
- Power Control Function: winch speeds adapted to the available power
- Potain Plus function: Plus load curves
- Container High Cube 40 ft, and/or Flat Rack 20 ft
- Consult us
- Hook heights with Plus load curves
- Hoisting
- Reactions in service
- Trolleying
- Reactions out of service
- Slewing

This commercial document is not legally binding. For any technical information, please refer to the corresponding instructions.

