

MD 689 M40

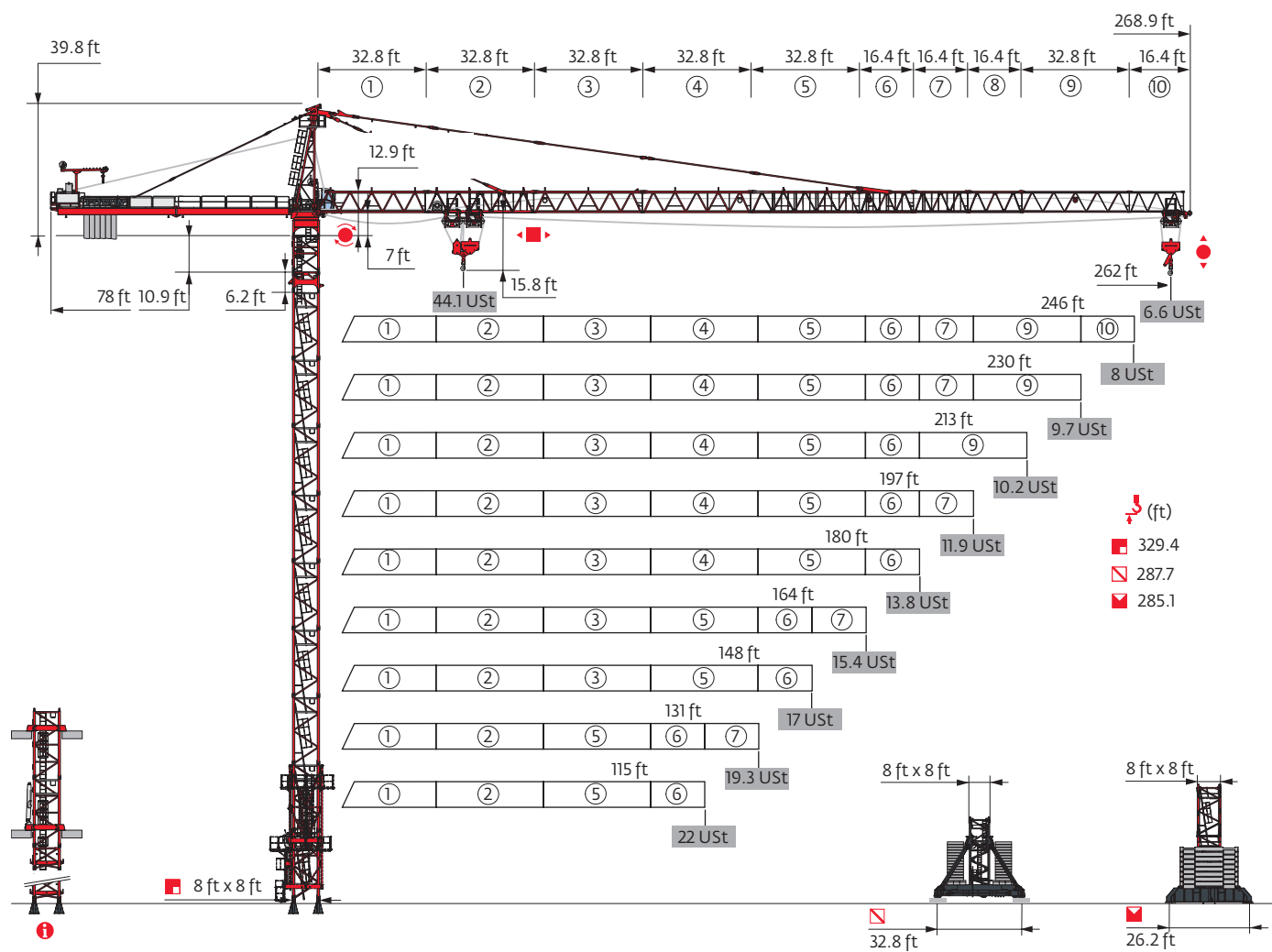

Potain Plus Power Control Top Site Top Tracing 3

P+
POTAIN CONNECT
Top Site
Top Tracing 3

Mast - Reactions

8 ft - P 854A										
Height (ft)	115	131	148	164	180	197	213	230	246	262
Height (ft)	295.9	295.9	295.9	295.9	295.9	295.9	290.7	290.7	274.3	285.1
Height/P _r (ft)	295.9	295.9	295.9	295.9	290.7	290.7	290.7	285.1	274.3	285.1
Platform Height	10.9 ft	1	1	1	1	1	1	1	1	1
	6.2 ft	1	1	1	1	1	1	1	1	1
	10.9 ft	2	2	2	2	2	0	0	0	1
	16.4 ft	16	16	16	16	16	17	17	16	16
F2 (Ust)	● 408	408	410	410	404	404	407	409	381	407
	■ 613	611	613	610	615	623	587	593	530	611
F3 (Ust)	● 281	279	279	276	267	265	267	267	244	264
	■ 509	504	504	499	500	506	470	473	415	490

8 ft - P 880A										
Height (ft)	115	131	148	164	180	197	213	230	246	262
Height (ft)	329.4	329.4	329.4	329.4	329.4	329.4	329.4	324.2	324.2	318.6
Height/P _r (ft)	329.4	329.4	329.4	329.4	329.4	324.2	324.2	324.2	324.2	318.6
Platform Height	10.9 ft	1	1	1	1	1	1	1	1	1
	6.2 ft	1	1	1	1	1	1	1	1	1
	10.9 ft	2	2	2	2	2	2	0	0	1
	16.4 ft	18	18	18	18	18	18	18	19	18
F2 (Ust)	● 475	474	473	473	481	462	457	473	469	475
	■ 848	847	853	851	867	852	840	826	815	837
F3 (Ust)	● 329	325	321	318	319	306	302	309	309	311
	■ 724	720	724	718	727	718	707	685	677	696

8 ft - JM 850										
Height (ft)	115	131	148	164	180	197	213	230	246	262
Height (ft)	265.8	287.7	287.7	282.2	271.3	282.2	287.7	260.2	282.2	276.6
Height/P _r (ft)	265.8	271.3	271.3	271.3	260.2	254.9	260.2	254.9	282.2	260.2
Platform Height	10.9 ft	1	1	1	1	1	1	1	1	1
	6.2 ft	1	1	1	1	1	1	1	1	1
	10.9 ft	1	0	0	1	0	1	0	2	1
	16.4 ft	13	15	15	14	14	14	15	12	14
F1 (Ust)	● 159	171	171	168	161	172	173	160	172	175
	■ 184	215	215	206	188	210	214	176	211	218

8 ft - ZY 854										
Height (ft)	115	131	148	164	180	197	213	230	246	262
Height (ft)	285.1	279.5	285.1	285.1	279.5	279.5	279.5	279.5	268.7	268.7
Height/P _r (ft)	285.1	279.5	285.1	285.1	279.5	279.5	279.5	279.5	268.7	268.7
Platform Height	10.9 ft	1	1	1	1	1	1	1	1	1
	6.2 ft	1	1	1	1	1	1	1	1	1
	10.9 ft	2	0	2	2	0	0	0	2	2
	16.4 ft	15	16	15	15	16	16	16	16	14
F1 (Ust)	● 236	231	238	239	237	238	238	241	228	234
	■ 288	269	288	286	271	277	273	277	261	281

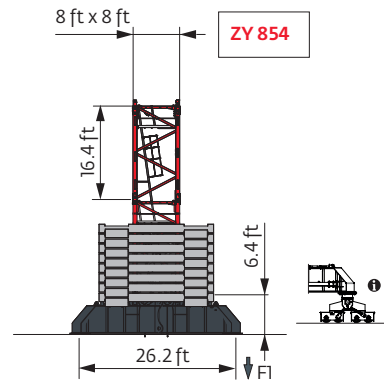
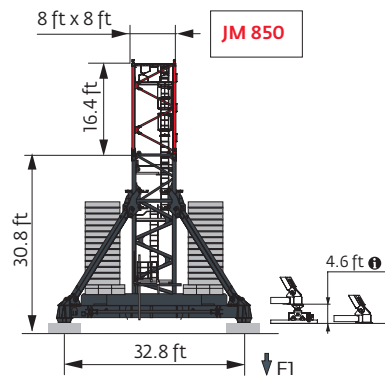
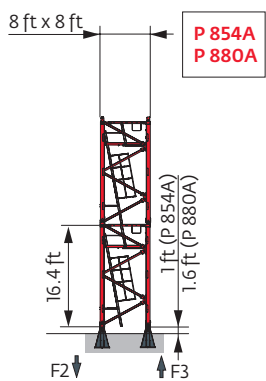

Other mast compositions - Please consult us.



Motorized accesses: adapted mast compositions, base ballast and reactions.



Note: When "ASCE" is noted in this data sheet it is referring to 115 mph Wind Zone, Exposure B, Design Wind Speed = 98 mph. See back cover for design wind speed calculations.

Anchorage



Base ballast

 (Ust) / 8 ft - JM 850 - 										
 (ft)	115	131	148	164	180	197	213	230	246	262
287.7		105.8	105.8				92.6			
282.2		105.8	92.6	92.6		92.6	79.4		79.4	
276.6		92.6	92.6	79.4		79.4	66.1		66.1	92.6
271.3		79.4	79.4	66.1	66.1	52.9	52.9		66.1	79.4
265.8	79.4	79.4	66.1	66.1	66.1	52.9	52.9		52.9	66.1
260.2	79.4	79.4	66.1	66.1	52.9	52.9	52.9	52.9	52.9	52.9
243.8	66.1	66.1	52.9	52.9	52.9	52.9	52.9	52.9	52.9	52.9
227.4	52.9	52.9	52.9	52.9	52.9	52.9	52.9	52.9	52.9	52.9
211	52.9	52.9	52.9	52.9	52.9	52.9	52.9	52.9	52.9	52.9
194.6	52.9	52.9	52.9	52.9	52.9	52.9	52.9	52.9	52.9	52.9
178.2	52.9	52.9	52.9	52.9	52.9	52.9	52.9	52.9	52.9	52.9
161.8	52.9	52.9	52.9	52.9	52.9	52.9	52.9	52.9	52.9	52.9
145.3	52.9	52.9	52.9	52.9	52.9	52.9	52.9	52.9	52.9	52.9
128.9	52.9	52.9	52.9	52.9	52.9	52.9	52.9	52.9	52.9	52.9
112.5	52.9	52.9	52.9	52.9	52.9	52.9	52.9	52.9	52.9	52.9
96.1	52.9	52.9	52.9	52.9	52.9	52.9	52.9	52.9	52.9	52.9
79.7	52.9	52.9	52.9	52.9	52.9	52.9	52.9	52.9	52.9	52.9

 (Ust) / 8 ft - ZY 854 - 										
 (ft)	115	131	148	164	180	197	213	230	246	262
285.1	198.4		185.2	185.2						
279.5	185.2	172	172	158.7	158.7	158.7	158.7	145.5		
268.7	158.7	145.5	145.5	132.3	132.3	132.3	132.3	119.1	132.3	158.7
252.3	132.3	119.1	119.1	119.1	119.1	119.1	119.1	119.1	105.8	105.8
235.9	105.8	105.8	105.8	105.8	105.8	92.6	92.6	92.6	92.6	105.8
219.5	92.6	92.6	92.6	92.6	92.6	79.4	79.4	92.6	92.6	92.6
203.1	79.4	79.4	79.4	79.4	79.4	79.4	79.4	92.6	92.6	92.6
186.7	79.4	79.4	79.4	79.4	79.4	79.4	79.4	79.4	92.6	92.6
170.3	79.4	79.4	79.4	79.4	79.4	79.4	79.4	79.4	79.4	92.6
153.9	79.4	79.4	79.4	79.4	79.4	79.4	79.4	79.4	79.4	92.6
137.5	79.4	79.4	79.4	79.4	79.4	79.4	79.4	79.4	79.4	79.4
121.1	79.4	79.4	79.4	79.4	79.4	79.4	79.4	79.4	79.4	79.4
104.7	79.4	79.4	79.4	79.4	79.4	79.4	79.4	79.4	79.4	79.4
88.3	79.4	79.4	79.4	79.4	79.4	79.4	79.4	79.4	79.4	79.4
71.9	79.4	79.4	79.4	79.4	79.4	79.4	79.4	79.4	79.4	79.4

Load curves



▲▲▲▲▲ (ft)		39	49	72	82	98	115	121	131	148	154	164	180	187	197	213	220	230	236	246	253	262	ft
▲▲▲▲▲	▲▲▲▲▲ 44.1 USt	▲▲▲▲▲ 22 USt					▲▲▲▲▲																
262	12.8 → 50.8 12.8 → 52.6	89 - 97	44.1 44.1 28.7 24.5	21.7 18.1 16.9 15.4 13.3 12.6 11.6 10.3 9.8 9.2 8.2 7.8 7.4 7.1 6.6 6.3 6	USt																		
246	12.8 → 53.2 12.8 → 56.6	87.8 - 93.8 93.5 - 100.6	44.1 44.1 29.1 24.3	20.7 16.8 15.5 13.9 12.5 12 11.3 10.4 10 9.6 8.7 8.4 7.9 7.7 7.3	USt																		
230	12.8 → 60 12.8 → 60.3	97.8 - 102 104 - 106.5	44.1 44.1 34.1 28.4	22 19.2 18.1 16.5 14.3 13.6 12.7 11.7 11.3 10.7 9.8 9.4 8.8	USt																		
213	12.8 → 57.3 12.8 → 60.4	100.2 - 107.4 107.8 - 112.8	44.1 44.1 33.3 28.4 22.6	20.4 19 17.3 15 14.2 13.1 11.6 11.1 10.4 9.3	USt																		
197	12.8 → 57.1 12.8 → 59.5	101.5 - 109 109.4 - 115.1	44.1 44.1 33.4 28.7 22.9	20.8 19.4 17.7 15.4 14.6 13.6 12.1 11.5 10.8	USt																		
180	12.8 → 58.5 12.8 → 60.8	105.3 - 113.3 112 - 119.1	44.1 44.1 34.6 29.8 23.9	21.7 20.4 18.6 16.2 15.4 14.3 12.8	USt																		
164	12.8 → 57.7 12.8 → 60.7	105 - 113.1 111.9 - 118.9	44.1 44.1 34.2 29.5 23.8	21.7 20.4 18.7 16.3 15.5 14.4	USt																		
148	12.8 → 57 12.8 → 59.8	103.8 - 111.8 110.2 - 117.1	44.1 44.1 33.7 29.1 23.5	21.4 20.1 18.4 16.1	USt																		
131	12.8 → 57.6 12.8 → 59.6	104.8 - 113 109.8 - 116.6	44.1 44.1 34.1 29.5 23.8	21.6 20.3 18.6	USt																		
115	12.8 → 58.1 12.8 → 59	106.5 - 114.8 108.5 - 114.8	44.1 44.1 34.6 29.9 24.2	22	USt																		

▲▲▲▲▲ = ▲▲▲▲▲ - 2.34 USt max.

Jib weight & counter-jib ballast

▲▲▲▲▲	▲▲▲▲▲ (lb) (+/- 5%)	▲▲▲▲▲		▲▲▲▲▲ (lb)
		13,228 lb	8,818 lb	
262 ft	63,405	6	0	79,366
246 ft	61,189	6	0	79,366
230 ft	59,976	5	1	74,957
213 ft	57,496	5	0	66,139
197 ft	56,901	4	1	61,729
180 ft	54,421	3	2	57,320
164 ft	50,794	2	2	44,092
148 ft	48,325	2	1	35,274
131 ft	44,158	1	2	30,865
115 ft	41,689	1	1	22,046

CBC - 13,228 lb



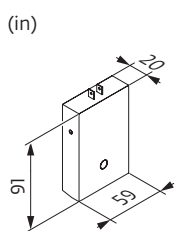
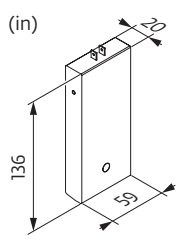

CBD - 8,818 lb





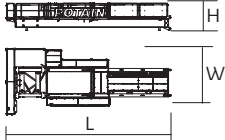
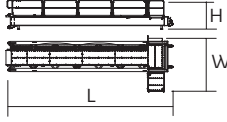
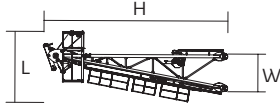

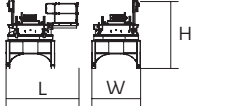
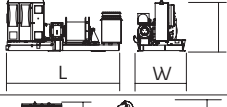
Dimensions and weight

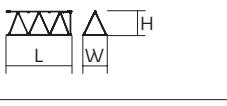
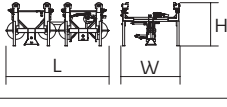
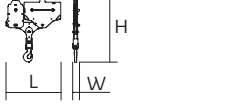
Slewing crane part :  262 ft -  320 LVF

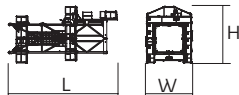
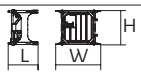

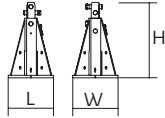
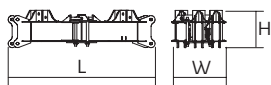
Slewing crane part		L (ft)	W (ft)	H (ft)	lb (+/- 5%)	
Counter-jib		38.4	15.4	6.4	14,551	
		36.2	12.3	6.8	10,858	
Cathead		11.6	6.5	32.3	18,221	
Cab	 Ultra View	16.4	8.2	9.1	4,134	
Towerhead	 8 ft	12.1	9.5	12.7	25,485	
Hoisting winch (+ rope)	 320 LVF	16.7	7.5	7.3	21,793	
Intermediate winch frame		10.7	9.5	5.4	12,485	
Jib section		①	34	6.2	8.3	11,241
		② 15 DVF	33.9	6.2	7.7	11,942
		③	33.6	6.2	7.9	6,634
		④	33.6	6.2	7.6	6,105
		⑤	33.6	6.2	7.6	6,279
⑨	33.5	6.2	6.6	3,075		
Jib section		⑥	17.5	6.2	7.4	4,222
		⑦	17.2	6.2	6.7	2,476
		⑧	17.2	6.2	6.7	2,211
		⑩	17	6.2	6.5	1,215
Trolley	 44.1 USt	13	7.2	5.5	3,131	
Pulley block	 44.1 USt	8.1	1.2	9.4	4,050	

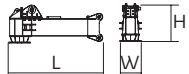
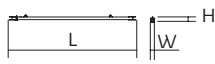
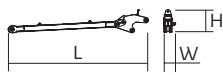
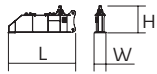
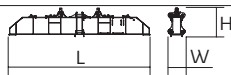
Crane Tower		L (ft)	W (ft)	H (ft)	lb (+/- 5%)	
Telescopic cage T 851		8 ft	36.7	15.9	19	34,723
K 85/K 85-2 Telescoping mast		8 ft	7.3	10.7	8.2	7,937
KM 850.10B KM 850.14B KMT 850.10A KMT 850.14A K 88/K 85A2 KM 880.10A KMT 850.10C		8 ft	33.9 33.9 17.5 17.5 17.5 17.8 12	8.3 8.3 8.3 8.3 8.2 8.3 8.3	8.2 8.2 8.2 8.2 8.2 8.3 8.2	22,201 24,670 12,015 13,206 18,281 18,453 9,326
Fixing angles		P 854A P 880A	3 3.3	3 3.3	4.9 6.2	2,072 3,536
Central cross (transport position)		JM 850	17.1	5.6	4.9	14,771
Basic mast unit		JM 850	28.7	8.2	8.2	32,187
Chassis girder		JM 850	17.1	3	5.1	7,055
Chassis ties		JM 850	23.6	0.8	1.1	551
Struts		JM 850	26.9	2.5	4.3	5,071
1/2 Cross girder		ZY 854	18.7	3.2	7.4	14,176
Cross girder		ZY 854	39	4.7	7.4	30,865

Mechanisms

480 V - 60 Hz													hp	kW			
	320 LVF 100 Optima	fpm	220	282	387	486	531	112	141	197	243	266	320	240	1,745 ft		
		USt	22	16.5	11	7.5	6.6	44.1	33.1	22	15.7	14					
	15 DVF 16 Optima	fpm	0 → 108 (44.1 USt) 0 → 164 (22 USt) 0 → 220 (11 USt) 0 → 328 (2.8 USt)												15	11	
	RVF 173 Optima+	rpm	0 → 0.8												3 x 10	3 x 7.5	

480 V (+6% -10%) 60 Hz	297 → 169 kVA	

These mast combinations meet the EN 14439 and ASME B30.3-2016 specifications for "out of service" wind conditions, provided the illustrated wind speed matches required design wind speed for the location of the tower crane. The "out of service" design wind speed was determined in accordance with ASCE 7-10, Figure 26.5-1A. The wind velocity, used for this configuration was 98 mph (158 kph), which represents a nominal design 3-second wind gust at 33 ft (10 m) above ground for Exposure B category. A factor of 0.85 was applied to the 700-year ultimate design wind speed of 115 mph (185 kph), per ASCE 37-02, with the assumption that this crane is considered a temporary structure used during a construction period of 2 years or less.

- Standard equipment
- Options
- Potain Plus function: Plus load curves
- Hook heights with Plus load curves
- Reactions in service
- Reactions out of service
- Total ballast weight
- Jib weight
- Lorry 44 ft
- Container High Cube 40 ft, and/or Flat Rack 20 ft
- Hoisting
- Trolleying
- Slewing
- Travelling
- Required power
- Power Control Function: winch speeds adapted to the available power
- Consult us

This commercial document is not legally binding. For any technical information, please refer to the corresponding instructions.

