

MD 569

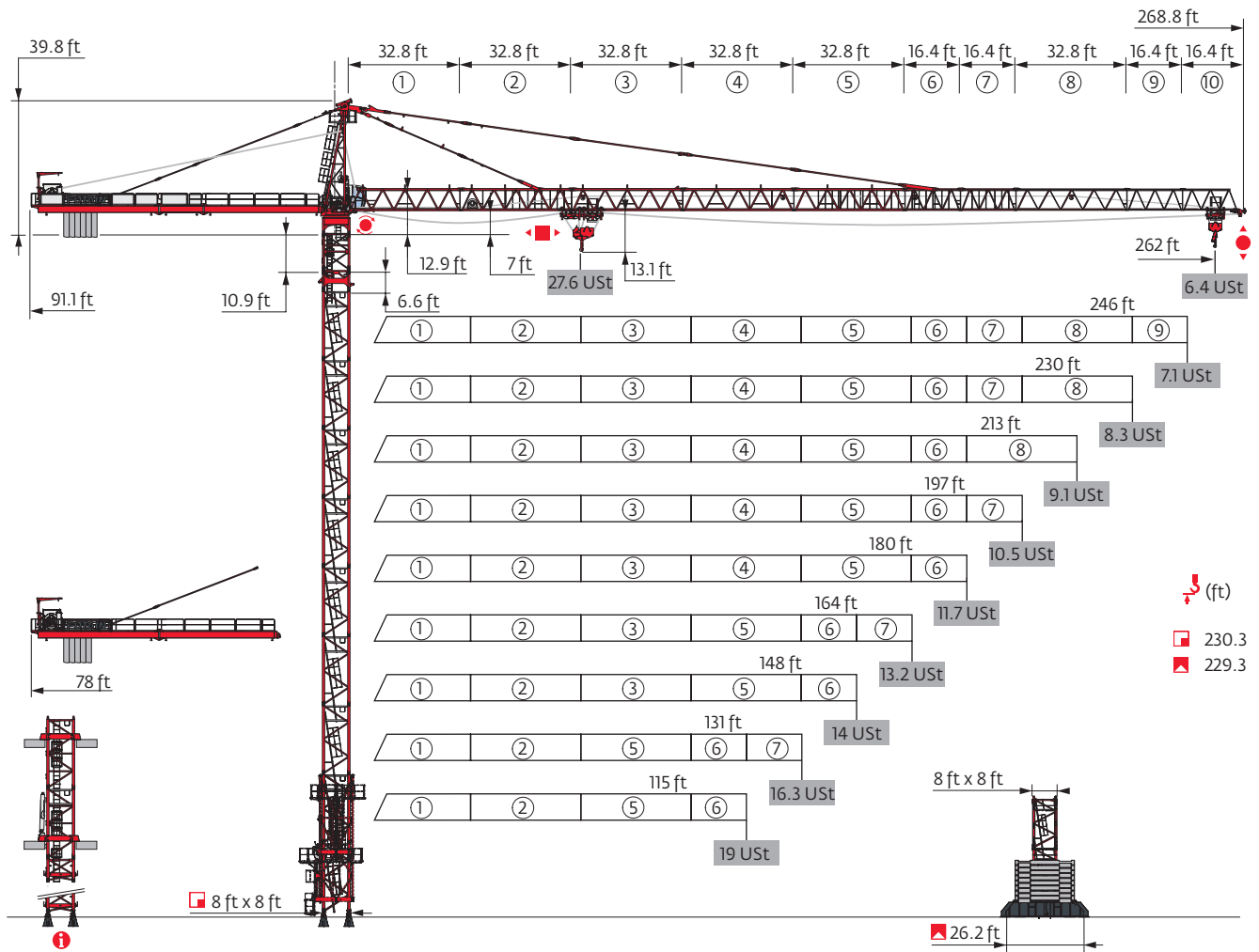

Potain Plus



Power Control

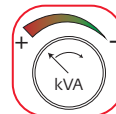

Top Site

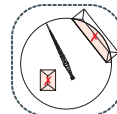

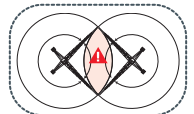

Top Tracing 3



Mast - Reactions

8 ft - P 800B										
Height (ft)	115	131	148	164	180	197	213	230	246	262
↓ (ft)	230.3	230.3	225.1	230.3	225.1	225.1	219.5	219.5	208.7	208.7
↓/P _r (ft)	230.3	230.3	225.1	230.3	225.1	225.1	219.5	219.5	208.7	208.7
	10.9 ft	1	1	1	1	1	1	1	1	1
	6.6 ft	1	1	1	1	1	1	1	1	1
	10.9 ft	2	2	0	2	0	0	1	1	0
	16.4 ft	12	12	13	12	13	13	12	12	12
F2 (Ust)	● 267	271	270	272	262	264	259	257	251	252
	■ 324	329	293	334	305	314	296	307	274	275
F3 (Ust)	● 171	172	183	169	173	159	168	150	149	150
	■ 242	244	206	245	215	223	205	214	181	180

8 ft - ZY 800 - 										
Height (ft)	115	131	148	164	180	197	213	230	246	262
↓ (ft)	229.3	229.3	207.7	229.3	218.5	218.5	212.9	218.5	207.7	202.1
↓/P _r (ft)	229.3	229.3	207.7	224.1	218.5	218.5	212.9	218.5	207.7	202.1
	10.9 ft	1	1	1	1	1	1	1	1	1
	6.6 ft	1	1	1	1	1	1	1	1	1
	10.9 ft	0	0	1	0	2	2	0	2	1
	16.4 ft	13	13	11	13	11	11	12	11	11
F1 (Ust)	● 148	147	139	142	143	147	140	146	143	141
	■ 144	146	115	149	133	137	129	140	130	127

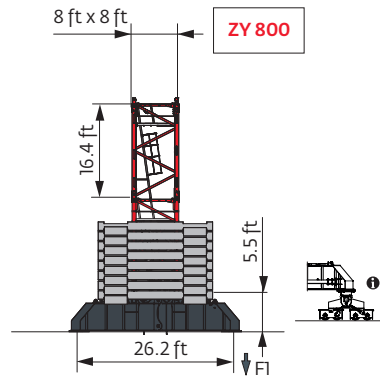
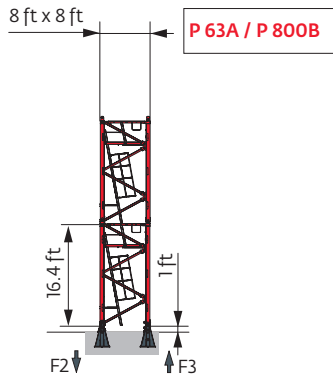

i Other mast compositions - Please consult us.

Motorized accesses: adapted mast compositions, base ballast and reactions.

Note: When "ASCE" is noted in this data sheet it is referring to 115 mph Wind Zone, Exposure B, Design Wind Speed = 98 mph. See back cover for design wind speed calculations.

Anchorage



Base ballast

(Ust) / 8 ft - ZY 800 -											
(ft)	115	131	148	164	180	197	213	230	246	262	
229.3	105.8	92.6		79.4							
218.5	92.6	92.6		79.4	92.6	92.6		92.6			
212.9	92.6	79.4		79.4	79.4	92.6	92.6	92.6			
207.7	79.4	79.4	79.4	79.4	79.4	79.4	92.6	92.6	92.6		
202.1	79.4	79.4	79.4	79.4	79.4	79.4	79.4	92.6	92.6	92.6	
185.7	79.4	79.4	79.4	79.4	79.4	79.4	79.4	92.6	92.6	92.6	
169.3	79.4	79.4	79.4	79.4	79.4	79.4	79.4	79.4	92.6	92.6	
152.9	79.4	79.4	79.4	79.4	79.4	79.4	79.4	79.4	79.4	92.6	
136.5	79.4	79.4	79.4	79.4	79.4	79.4	79.4	79.4	79.4	79.4	
120.1	79.4	79.4	79.4	79.4	79.4	79.4	79.4	79.4	79.4	79.4	
103.7	79.4	79.4	79.4	79.4	79.4	79.4	79.4	79.4	79.4	79.4	
87.3	79.4	79.4	79.4	79.4	79.4	79.4	79.4	79.4	79.4	79.4	
70.9	79.4	79.4	79.4	79.4	79.4	79.4	79.4	79.4	79.4	79.4	

Load curves



▼ (ft)			56	66	82	89	98	115	121	131	148	154	164	180	187	197	213	220	230	236	246	253	262	ft
▼	▼ 27.6 USt	▼ → ▼ 13.8 USt	▼										▼											
262	12 → 68	121 - 133	27.6	27.6	22.2	20.3	17.8	14.7	13.8	13.8	12.2	11.5	10.7	9.6	9.2	8.6	7.8	7.5	7.1	6.8	6.5	6.2	5.9	USt
	12 → 70	126 - 138	27.6	27.6	23	21.1	18.6	15.4	14.4	13.8	12.8	12.2	11.3	10.1	9.7	9.1	8.3	8	7.5	7.3	6.9	6.7	6.4	USt P+
246	12 → 69	123 - 134	27.6	27.6	22.5	20.5	18.1	15	14	13.8	12.3	11.7	10.9	9.7	9.3	8.7	7.9	7.6	7.2	6.9	6.6			USt
	12 → 71	128 - 140	27.6	27.6	23.4	21.4	18.9	15.8	14.7	13.8	13	12.4	11.5	10.3	9.9	9.3	8.4	8.1	7.7	7.5	7.1			USt P+
230	12 → 72	130 - 140	27.6	27.6	23.8	21.8	19.2	16	14.9	13.8	13	12.4	11.5	10.3	9.9	9.3	8.4	8.1	7.7					USt
	12 → 75	136 - 148	27.6	27.6	24.9	22.8	20.2	16.9	15.8	14.4	13.8	13.1	12.2	11	10.5	9.9	9	8.7	8.3					USt P+
213	12 → 73	130 - 141	27.6	27.6	23.9	21.9	19.3	16.1	15	13.8	13.1	12.4	11.6	10.3	9.9	9.3	8.5							USt
	12 → 76	137 - 149	27.6	27.6	25.1	23	20.4	17	15.9	14.5	13.8	13.2	12.3	11.1	10.6	10	9.1							USt P+
197	12 → 76	135 - 147	27.6	27.6	25.1	22.9	20.3	16.9	15.8	14.3	13.7	13	12.1	10.8	10.4	9.8								USt
	12 → 79	143 - 155	27.6	27.6	26.4	24.2	21.4	17.9	16.8	15.3	13.8	13.8	13	11.6	11.2	10.5								USt P+
180	12 → 76	136 - 148	27.6	27.6	25.2	23	20.3	16.9	15.8	14.4	13.7	13.1	12.2	10.9										USt
	12 → 79	144 - 156	27.6	27.6	26.6	24.3	21.6	18	16.9	15.4	13.8	13.8	13.1	11.7										USt P+
164	12 → 76	136 - 148	27.6	27.6	25.2	23.1	20.4	17	15.9	14.4	13.8	13.1	12.2											USt
	12 → 80	145 - 157	27.6	27.6	26.7	24.5	21.7	18.2	17	15.5	13.8	13.8	13.2											USt P+
148	12 → 76	136 - 148	27.6	27.6	25.2	23	20.4	16.9	15.8	14.4	13.8													USt
	12 → 80	145 - 148	27.6	27.6	26.8	24.5	21.8	18.2	17.1	15.5	13.8													USt P+
131	12 → 76		27.6	27.6	25.4	23.2	20.5	17.1	16	14.5														USt
	12 → 81		27.6	27.6	27	24.8	22	18.4	17.3	15.7														USt P+
115	12 → 76		27.6	27.6	25.4	23.2	20.5	17.1																USt
	12 → 81		27.6	27.6	27	24.9	22.1	18.5																USt P+

$USt = USt - 1.59 USt \text{ max.}$



▼ (ft)			56	66	82	89	98	115	121	131	148	154	164	180	187	197	213	220	230	236	246	253	262	ft
▼	▼ 27.6 USt	▼ → ▼ 13.8 USt	▼										▼											
262	9 → 70	127 - 129	27.6	27.6	23	21.1	18.6	15.5	14.5	13.5	11.7	11.1	10.3	9.1	8.7	8.2	7.3	7.1	6.6	6.4	6	5.8	5.5	USt
	9 → 72	132 - 135	27.6	27.6	23.8	21.8	19.4	16.2	15.2	13.8	12.4	11.7	10.9	9.7	9.3	8.7	7.9	7.5	7.1	6.9	6.5	6.3	6	USt P+
246	9 → 71	128 - 130	27.6	27.6	23.2	21.2	18.8	15.7	14.7	13.7	11.9	11.3	10.4	9.3	8.9	8.3	7.5	7.2	6.8	6.5	6.2			USt
	9 → 73	133 - 136	27.6	27.6	24.1	22.1	19.6	16.4	15.4	14.1	12.6	11.9	11.1	9.9	9.5	8.9	8	7.7	7.3	7	6.7			USt P+
230	9 → 74	134 - 137	27.6	27.6	24.4	22.4	19.8	16.6	15.5	14.1	12.6	12	11.1	9.9	9.5	8.9	8	7.7	7.3					USt
	9 → 76	141 - 144	27.6	27.6	25.5	23.4	20.8	17.4	16.4	15	13.4	12.7	11.8	10.6	10.1	9.5	8.6	8.3	7.9					USt P+
213	9 → 74	134 - 138	27.6	27.6	24.5	22.5	19.9	16.6	15.6	14.2	12.7	12	11.2	9.9	9.5	8.9	8							USt
	9 → 77	142 - 145	27.6	27.6	25.7	23.6	20.9	17.6	16.5	15.1	13.5	12.8	11.9	10.6	10.2	9.6	8.7							USt P+
197	9 → 77	140 - 143	27.6	27.6	25.6	23.5	20.8	17.4	16.3	14.9	13.3	12.6	11.7	10.4	10	9.4								USt
	9 → 80	148 - 151	27.6	27.6	26.9	24.7	22	18.5	17.4	15.9	13.8	13.5	12.6	11.2	10.8	10.1								USt P+
180	9 → 77	140 - 143	27.6	27.6	25.7	23.6	20.9	17.5	16.4	14.9	13.3	12.7	11.8	10.5										USt
	9 → 81	149 - 152	27.6	27.6	27.1	24.9	22.2	18.6	17.5	16	13.9	13.6	12.6	11.3										USt P+
164	9 → 77	141 - 144	27.6	27.6	25.8	23.7	21	17.6	16.4	15	13.4	12.7	11.8											USt
	9 → 81	150 - 153	27.6	27.6	27.3	25.1	22.3	18.8	17.6	16.1	14	13.7	12.7											USt P+
148	9 → 77	141 - 144	27.6	27.6	25.8	23.6	20.9	17.5	16.4	15	13.3													USt
	9 → 81		27.6	27.6	27.3	25.1	22.3	18.8	17.6	16.1	14													USt P+
131	9 → 78		27.6	27.6	26	23.8	21.1	17.7	16.6	15.1														USt
	9 → 82		27.6	27.6	27.6	25.4	22.6	19	17.8	16.3														USt P+
115	9 → 78		27.6	27.6	25.9	23.8	21.1	17.6																USt
	9 → 82		27.6	27.6	27.6	25.5	22.7	19																USt P+

$USt = USt - 0.38 USt \text{ max.}$

Jib weight & counter-jib ballast

▼ (ft)	▼ (lb) (+/- 5%)		132 HPL™			180 HPL™ GH		
	▼ → ▼	▼ → ▼	13,228 lb	8,818 lb	▼ (lb)	13,228 lb	8,818 lb	▼ (lb)
262 ft	56,516	57,596	6	0	79,366	4	2	70,548
246 ft	55,413	56,493	5	1	74,957	3	3	66,139
230 ft	54,201	55,281	5	1	74,957	2	4	61,729
213 ft	51,809	52,889	5	0	66,139	1	5	57,320
197 ft	51,136	52,216	5	0	66,139	2	3	52,911
180 ft	48,744	49,824	4	1	61,729	1	4	48,502
164 ft	45,040	46,121	5	0	66,139	2	3	52,911
148 ft	42,659	43,740	4	1	61,729	2	3	52,911
131 ft	38,592	39,672	2	3	52,911	1	3	39,683
115 ft	36,211	37,291	1	4	48,502	0	4	35,274

CBC - 13,228 lb

CBD - 8,818 lb

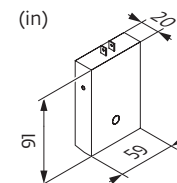
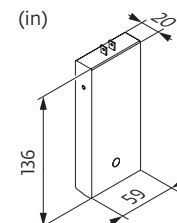



Dimensions and weight

Slewing crane: 262 ft - 132 HPL™

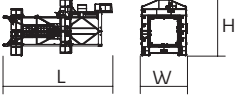

Slewing crane part		L (ft)	W (ft)	H (ft)	lb (+/- 5%)
Counter-jib		38.4	13.5	6.4	14,308
		13.8	6.6	6.4	4,365
		36.2	11.7	6.8	10,858
Cathead		11.6	6.5	32.3	18,221
Cab	Ultra View	16.4	8.2	9.1	4,134
Towerhead	8 ft	12.1	9.5	12.7	24,670
Hoisting winch (+ rope)	132 HPL™	12.4	6.1	6.2	11,387
	180 HPL™ GH	15.8	6.3	6.5	19,279
Jib section	①	34	6.2	8.3	11,188
	② 10 DVF	33.9	6.2	7.7	10,439
	③	33.6	6.2	7.9	6,625
	④	33.6	6.2	7.6	6,096
	⑤	33.6	6.2	7.6	6,250
Jib section	⑥	33.5	6.2	6.6	3,064
	⑦	17.5	6.2	7.4	3,792
	⑧	17.2	6.2	6.7	2,381
	⑨	17	6.2	6.5	1,213
Trolley	27.6 USt	5.9	7.4	4.7	1,676
	27.6 USt	3.9	1.4	7.8	1,874
Trolley	27.6 USt	13.5	7.2	3.8	2,635
Pulley block	27.6 USt	6	1.1	7.7	1,995

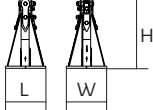
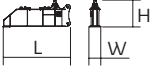
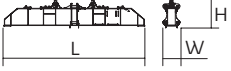
Crane Tower	L (ft)	W (ft)	H (ft)	lb (+/- 5%)
Telescopic cage T 851 	8 ft	36.7	15.9	19 34,723
K 84/K 84-2 Telescoping mast 	8 ft	7.3	10.6	8.2 6,724
KRM 849B KMT 849A KR 849A KRMT 849A KRMT 849C 	8 ft	33.6 17.2 17.2 17.2 11.7	8.4 8.4 8.3 8.4 8.4	8.3 8.3 8.2 8.3 8.3 17,196 6,945 9,458 9,017 7,066
Fixing angles 	P 63A / P 800B	2.5	2.5	4.2 1,025
1/2 Cross girder 	ZY 800	18.6	3.2	6.3 10,406
Cross girder 	ZY 800	39.2	4.6	6.3 22,212

Mechanisms

480 V - 60 Hz													hp	kW	
	132 HPL™ 63	fpm	133	172	243	363	502	67	87	125	185	251	132	98	2,815 ft
		USt	13.8	10.4	6.9	3.4	1.1	27.6	20.7	13.8	6.9	2.9			
	180 HPL™ 63 GH	fpm	179	220	289	438	640	90	112	149	238	320	180	132	3,937 ft
		USt	13.8	10.4	6.9	3.4	0.9	27.6	20.7	13.8	6.9	3.3			
	10 DVF 10 Optima	fpm	0 → 217 (27.6 USt) 0 → 262 (22 USt) 0 → 328 (13.8 USt) 0 → 361 (6.9 USt)					10	7.4						
	RVF 173 Optima+	rpm	0 → 0.8					3 x 10	3 x 7.5						
480 V(+6% -10%) 60 Hz			132 HPL™: 142 → 90 kVA 180 HPL™ GH: 181 → 109 kVA												

These mast combinations meet the EN 14439 and ASME B30.3-2016 specifications for "out of service" wind conditions, provided the illustrated wind speed matches required design wind speed for the location of the tower crane. The "out of service" design wind speed was determined in accordance with ASCE 7-10, Figure 26.5-1A. The wind velocity, used for this configuration was 98 mph (158 kph), which represents a nominal design 3-second wind gust at 33 ft (10 m) above ground for Exposure B category. A factor of 0.85 was applied to the 700-year ultimate design wind speed of 115 mph (185 kph), per ASCE 37-02, with the assumption that this crane is considered a temporary structure used during a construction period of 2 years or less.

- Standard equipment
- Options
- Potain Plus function: Plus load curves
- Hook heights with Plus load curves
- Reactions in service
- Reactions out of service
- Total ballast weight
- Jib weight
- Lorry 44 ft
- Container High Cube 40 ft, and/or Flat Rack 20 ft
- Hoisting
- Trolleying
- Slewing
- Travelling
- Required power
- Power Control Function: winch speeds adapted to the available power
- Consult us

This commercial document is not legally binding. For any technical information, please refer to the corresponding instructions.

