

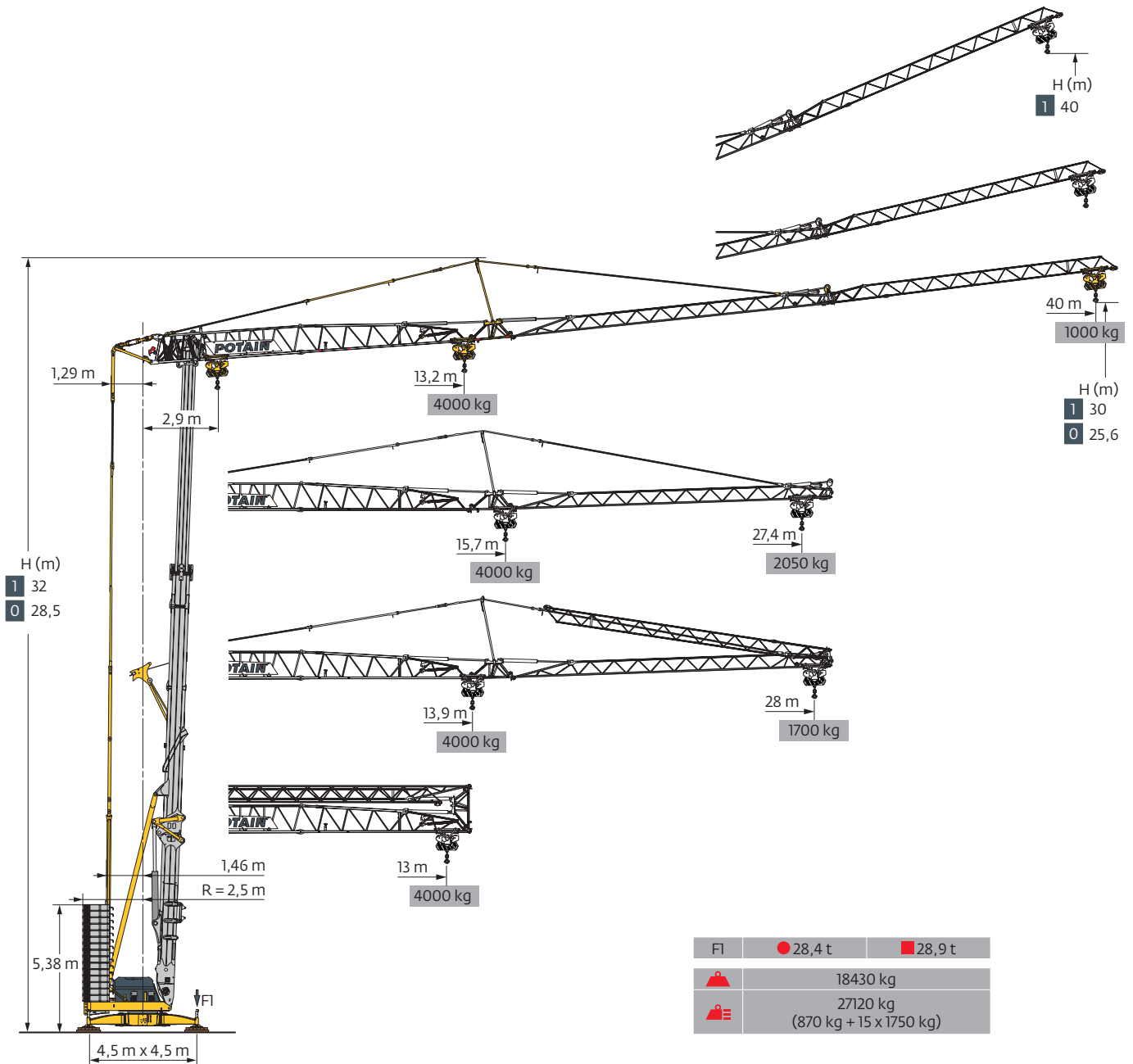

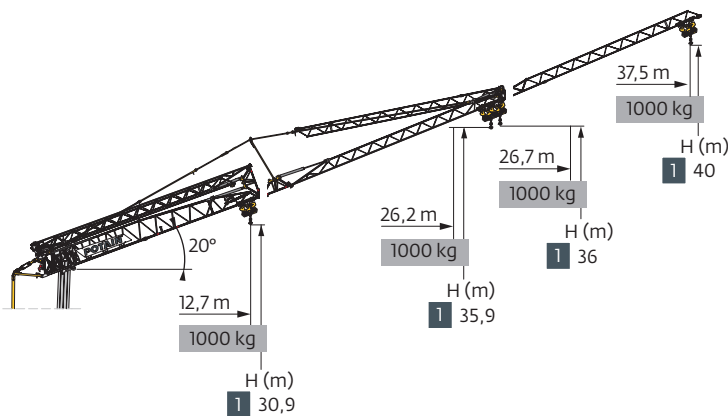

Hup 40-30

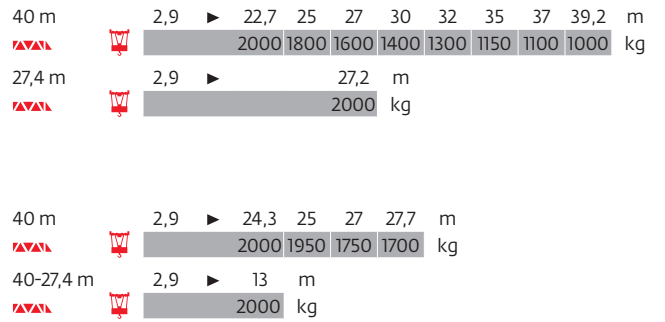

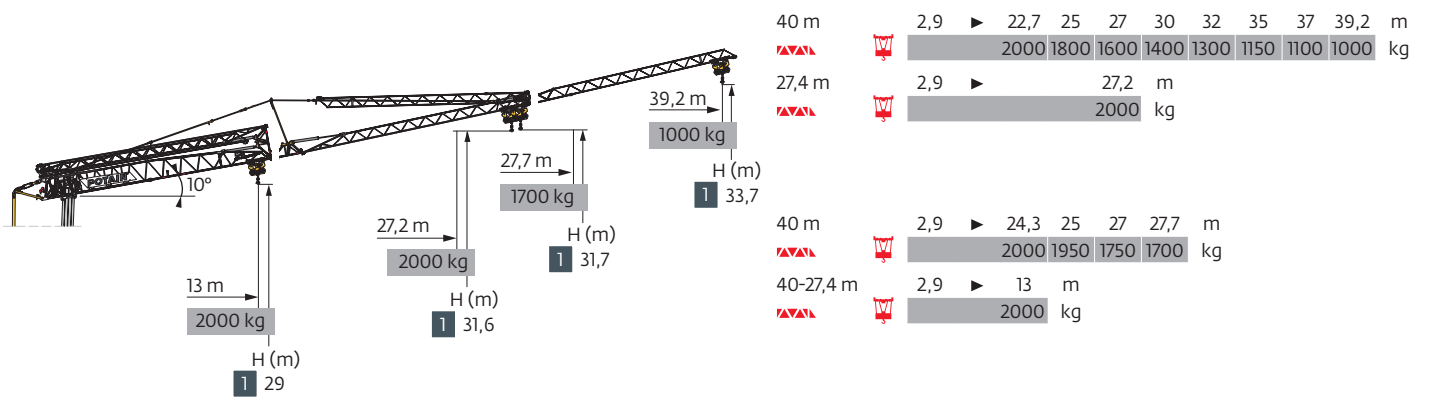
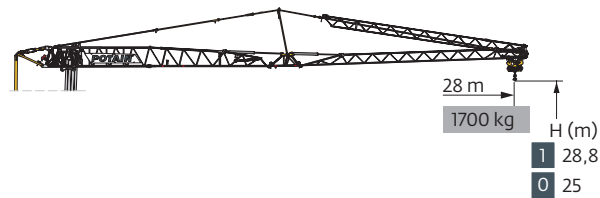
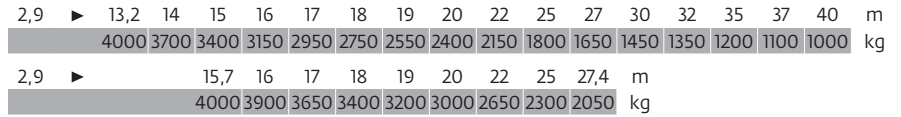
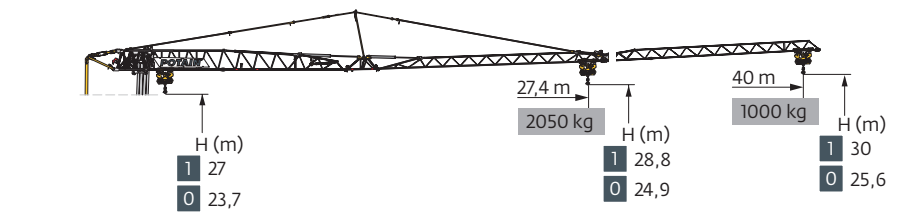
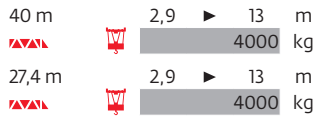
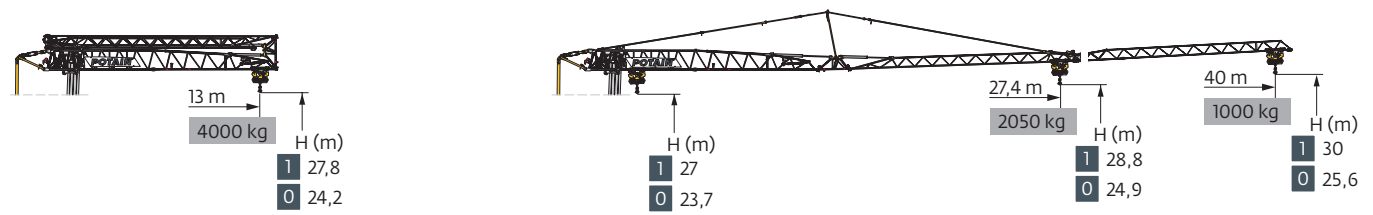



Courbes de charges / Lastkurven / Load curves / Curvas de cargas / Curve di carico
 Curvas de carga / Кривые нагрузок



Mécanismes / Triebwerke / Mechanisms / Mecanismos / Meccanismi
 Mecanismos / Механизмы

400 V - 50 Hz 480 V - 60 Hz								ch - PS hp	kW
	18 HPL™ 10	m/min	2,1	19	36	58	65	18	13
		kg	4000	4000	2000	1000	500		
	3 DVF 5	m/min	1 → 45 (0 → 1000 kg) 1 → 41 (1000 → 4000 kg)					3	2,2
	HPS 142	tr/min U/min rpm	0 → 0,9					2 x 5	2 x 3,7

 IEC 60204-32	 kVA	
400 V (+10% -10%) 50 Hz 480 V (+6% -10%) 60 Hz	23 → 17 kVA	

Montage / Montage / Erection / Montaje / Montaggio
 Montagem / Монтаж

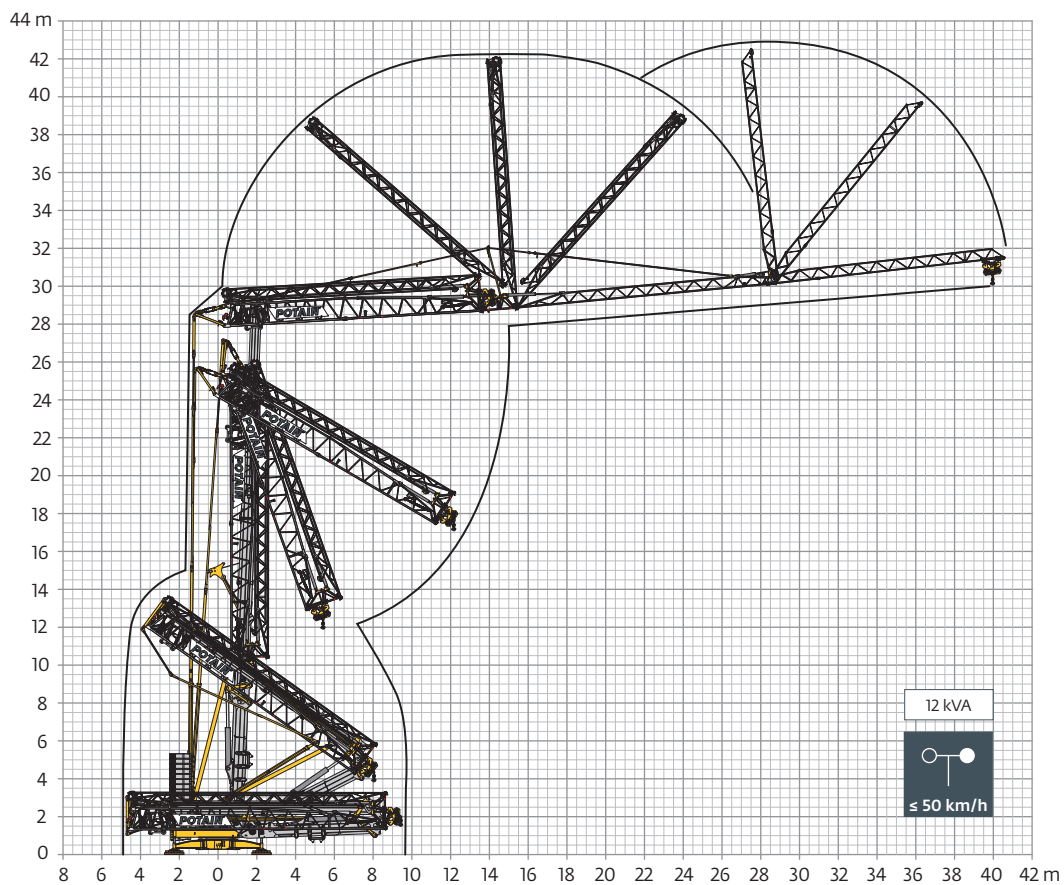

Transport / Transport / Transport / Transporte / Trasporto
Transporte / Транспортировка

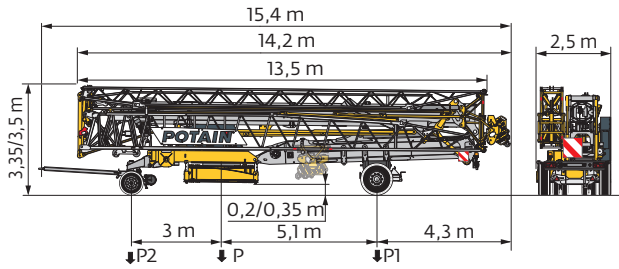

	km/h	P (kg)	P1 (kg)	P2 (kg)
DJ100/S120	10	20320	11870	8450
DJ105A/S125A	25	20580	11980	8600

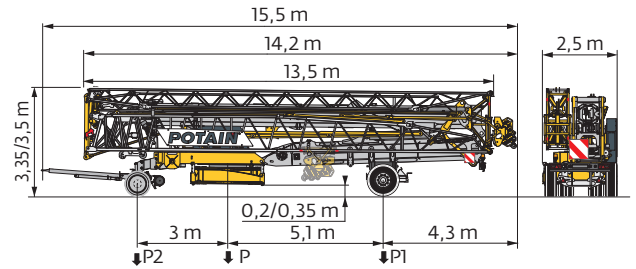

	km/h	P (kg)	P1 (kg)	P2 (kg)
DJ126MA/S125A	25	20780	12000	8780
..... /..... ⓘ				

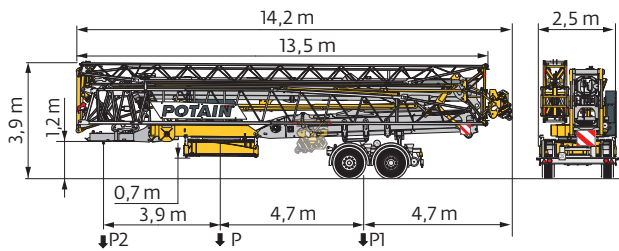

	km/h	P (kg)	P1 (kg)	P2 (kg)
SL121/S215M	25	21880	14710	7170

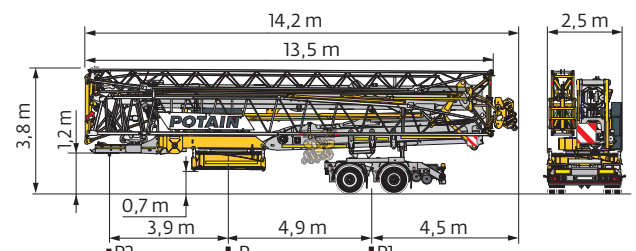

	km/h	P (kg)	P1 (kg)	P2 (kg)
SL122/J215M (EBS)	80	21680	14510	7170

	FR	DE	EN	ES	IT	PT	RU
R	Rayon de giration	Schwenk radius	Rear slewing radius	Radio de giro	Raggio di rotazione	Raio de rotação	Задний габарит
ⓘ	Nous consulter	Auf Anfrage	Consult us	Consultarnos	Consultateci	Consultar-nos	Проконсультируйтесь у нас
●	Réactions en service	Reaktionskräfte in Betrieb	Reactions in service	Reacciones en servicio	Reazioni in servizio	Reacções em serviço	Реакция при работе
■	Réactions hors service	Reaktionskräfte außer Betrieb	Reactions out of service	Reacciones fuera de servicio	Reazioni fuori servizio	Reacções fora de serviço	Реакция в покое
⚖	Poids à vide, sans lest, sans trains de transport, avec flèche maxi. et hauteur standard.	Gewicht ohne Last, ohne Ballast, ohne Transportachsen, mit max. Auslager und Standardhöhe	Weight without load, without ballast, without transport axes, with max. jib and standard height	Peso en vacío, sin lastre, sin trenes de transporte con flecha y altura estándar	Peso a vuoto, senza zavorra, senza assali di trasporto, con braccio max e altezza standard.	Peso em vazio, sem lastro, sem eixos de transporte com lança máxima e altura standard.	Вес без груза, без балласта, без осей для транспортировки, с максимальным вылетом стрелы и стандартной высотой
⚖	Poids total du lest	Ballast-Gesamtgewicht	Total ballast weight	Peso total del lastre	Peso totale della zavorra	Peso total do lastro	Общий вес балласта
□	Équipements standards	Standardausrüstungen	Standard equipment	Equipamiento de serie	Equipaggiamento standard	Equipamento de série	Стандартное оборудование
⊞	Équipements optionnels	Sonderausrüstungen	Options	Equipamiento opcional	Equipaggiamento in opzione	Equipamento opcional	Дополнительное оборудование (опция)
⬆	Levage	Heben	Hoisting	Elevación	Sollevaramento	Elevação	Подъем
➡	Distribution	Katzfahren	Trolleying	Distribución	Distribuzione	Distribuição	Перемещение по стреле
🔄	Orientation	Schwenken	Slewing	Orientación	Rotazione	Rotação	Поворот
kVA	Puissance requise	Erforderliche Leistung	Required power	Potencia Necesaria	Potenza richiesta	Potência Necessária	Потребляемая мощность
⚙	Fonction Power Control : vitesses treuils adaptées à la puissance disponible	Funktion Power Control: Geschwindigkeiten der Triebwerke werden an die verfügbare Leistung angepasst	Power Control Function: winch speeds adapted to the available power	Función Power Control: marchas de los cabrestantes adaptadas a la potencia disponible	Funzione Power Control: velocità degli argani adattate alla potenza disponibile	Função Power Control: velocidades de guincho adaptadas à potência disponível	Функция контроля мощности Power Control: регулировка скорости лебедок в зависимости от доступной мощности

⚠	Hauteurs sous crochet données moufle plaquée	Hakenhöhen werden mit plattiertem Haken angegeben	Hook heights given with plated pulley block	Altura bajo gancho con pasteca bloqueada	Altezza sotto gancio con bozzello in contatto con carrello	Altura ao gancho com o cadernal em contacto com o carrinho	высота под крюком дана при условии, что крюковая подвеска соприкасается с кареткой
	Document commercial non contractuel	Unverbindliches Vertriebsdokument	This commercial document is not legally binding	Documento comercial no contractual	Documento commerciale non vincolante	Documento comercial não contratual	Этот коммерческий документ не является юридически обязательным
	Pour toute information technique se référer à la notice correspondante	Für technische Informationen, siehe die entsprechenden Anweisungen	For any technical information, please refer to the corresponding instructions	Para cualquier información técnica, ver la noticia correspondiente	Per tutte le informazioni tecniche fare riferimento al catalogo istruzioni	Para qualquer informação técnica complementar consultar as respectivas instruções	Для получения технической информации, см. соответствующие инструкции

