

## MD 509 M20

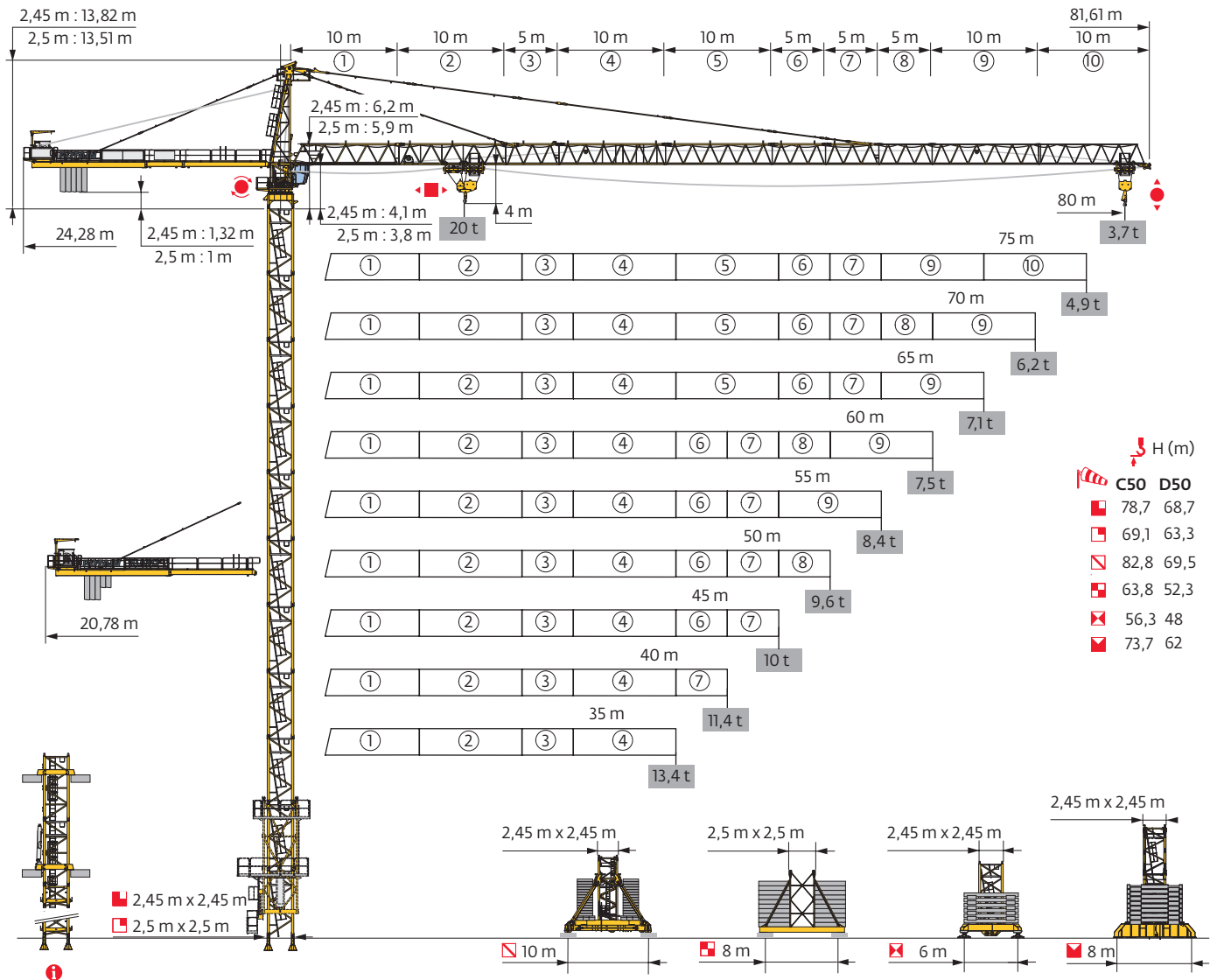

Potain Plus



Power Control

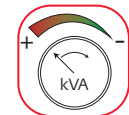

CraneSTAR



Top Site

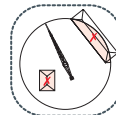

Top Tracing 3

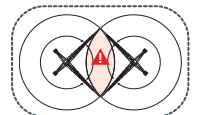

Mât - Réactions / Mast - Reaktionskräfte / Mast - Reactions / Mástil - Reacciones / Torre - Reazioni  
 Tramo - Reacções / Реакция опор мачты

**2,45 m - P 800B - C50**

AVAIL (m)	35	40	45	50	55	60	65	70	75	80
$\downarrow$ (m)	65,4	65,4	65,4	65,4	65,4	65,4	65,4	65,4	63,7	65,4
$\downarrow/P_+$ (m)	65,4	65,4	65,4	65,4	65,4	65,4	65,4	65,4	63,7	65,4
3,33 m	0	0	0	0	0	0	0	0	1	0
	5 m	13	13	13	13	13	13	13	12	13
F2 (t)	● 204	210	210	206	206	208	207	209	194	197
	■ 355	362	366	361	366	369	367	372	362	373
F3 (t)	● 142	145	143	137	139	140	136	137	123	123
	■ 304	307	309	302	309	311	306	310	301	309
$\downarrow$ (m) D50	55,4	55,4	55,4	55,4	55,4	55,4	55,4	55,4	55,4	55,4
$\downarrow/P_+$ (m) D50	55,4	55,4	55,4	55,4	55,4	55,4	55,4	55,4	55,4	55,4

**2,45 m - P 854A - C50**

AVAIL (m)	35	40	45	50	55	60	65	70	75	80
$\downarrow$ (m)	78,7	77	77	78,7	77	77	77	77	75,4	77
$\downarrow/P_+$ (m)	78,7	77	77	78,7	77	77	77	77	75,4	77
3,33 m	1	2	2	1	2	2	2	2	0	2
	5 m	15	14	14	15	14	14	14	15	14
F2 (t)	● 241	245	244	244	241	243	242	244	228	239
	■ 544	535	538	550	539	542	540	546	507	547
F3 (t)	● 171	171	169	166	166	166	162	163	149	156
	■ 484	470	473	482	473	475	470	475	438	474
$\downarrow$ (m) D50	68,7	67	67	68,7	67	67	67	67	67	67
$\downarrow/P_+$ (m) D50	68,7	67	67	68,7	67	67	67	67	67	67

**2,45 m - JM 850 - C50**

AVAIL (m)	35	40	45	50	55	60	65	70	75	80
$\downarrow$ (m)	81,1	81,1	81,1	82,8	81,1	81,1	82,8	81,1	81,1	81,1
$\downarrow/P_+$ (m)	81,1	81,1	81,1	82,8	81,1	81,1	82,8	81,1	81,1	81,1
3,33 m	2	2	2	1	2	2	1	2	2	2
	5 m	13	13	13	14	13	13	14	13	13
F1 (t)	● 148	151	151	153	151	152	154	150	152	151
	■ 232	234	235	241	236	237	244	237	240	237
$\downarrow$ (m) D50	67,8	67,8	69,5	69,5	69,5	69,5	69,5	69,5	69,5	69,5
$\downarrow/P_+$ (m) D50	67,8	67,8	69,5	69,5	69,5	69,5	69,5	69,5	69,5	69,5

**2,45 m - ZX 6830 - C50**

AVAIL (m)	35	40	45	50	55	60	65	70	75	80
$\downarrow$ (m)	56,3	56,3	56,3	56,3	56,3	56,3	56,3	56,3	56,3	56,3
$\downarrow/P_+$ (m)	56,3	56,3	56,3	56,3	56,3	56,3	56,3	56,3	56,3	56,3
3,33 m	0	0	0	0	0	0	0	0	0	0
	5 m	11	11	11	11	11	11	11	11	11
F1 (t)	● 134	138	138	135	137	138	136	137	135	131
	■ 161	164	166	161	166	168	164	168	171	167
$\downarrow$ (m) D50	46,3	46,3	46,3	48	46,3	46,3	48	48	46,3	48
$\downarrow/P_+$ (m) D50	46,3	46,3	46,3	48	46,3	46,3	48	48	46,3	48

**2,45 m - ZY 800 - C50**

AVAIL (m)	35	40	45	50	55	60	65	70	75	80
$\downarrow$ (m)	65,1	65,1	63,4	65,1	63,4	63,4	65,1	63,4	63,4	63,4
$\downarrow/P_+$ (m)	65,1	65,1	63,4	65,1	63,4	63,4	65,1	63,4	63,4	63,4
3,33 m	1	1	2	1	2	2	1	2	2	2
	5 m	12	12	11	12	11	11	12	11	11
F1 (t)	● 132	135	131	133	131	132	134	131	130	127
	■ 177	180	173	179	173	175	182	177	181	179
$\downarrow$ (m) D50	56,7	55	55	56,7	55	55	55	55	55	55
$\downarrow/P_+$ (m) D50	56,7	55	55	56,7	55	55	55	55	55	55

**2,45 m - ZY 854 - C50**

AVAIL (m)	35	40	45	50	55	60	65	70	75	80
$\downarrow$ (m)	72	72	72	73,7	72	72	73,7	73,7	72	73,7
$\downarrow/P_+$ (m)	72	72	72	73,7	72	72	73,7	73,7	72	73,7
3,33 m	0	0	0	2	0	0	2	2	0	2
	5 m	14	14	14	13	14	14	13	13	14
F1 (t)	● 155	156	157	163	156	157	164	166	156	163
	■ 223	227	230	244	230	232	247	252	239	254
$\downarrow$ (m) D50	60,3	60,3	60,3	62	60,3	60,3	62	62	60,3	62
$\downarrow/P_+$ (m) D50	60,3	60,3	60,3	62	60,3	60,3	62	62	60,3	62

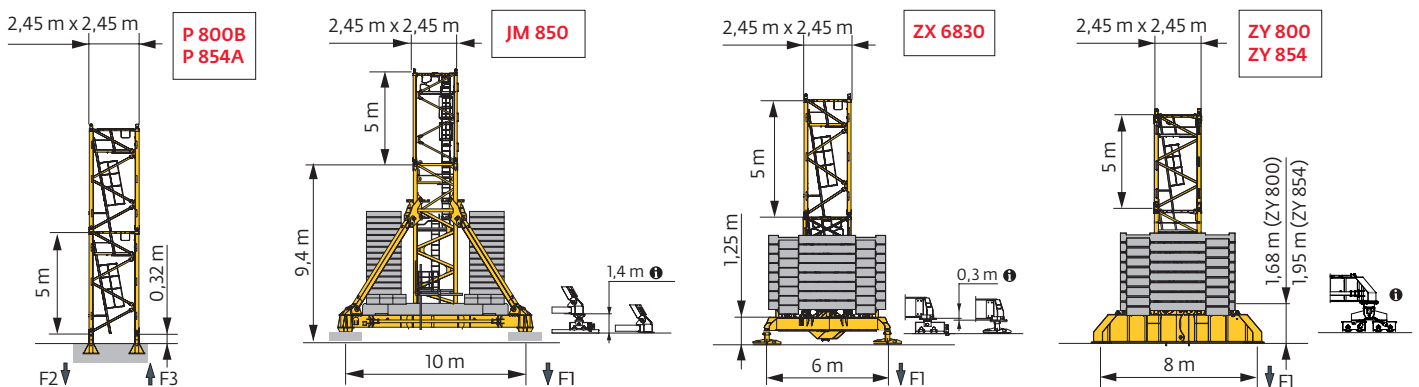

2,5 m - P 80A - C50										
▲▼▲ (m)	35	40	45	50	55	60	65	70	75	80
↕ (m)	69,1	69,1	69,1	69,1	69,1	69,1	69,1	69,1	69,1	69,1
↕/P+ (m)	69,1	69,1	69,1	69,1	69,1	69,1	69,1	69,1	69,1	69,1
⌘	11,2 m	1	1	1	1	1	1	1	1	1
	5,78 m	10	10	10	10	10	10	10	10	10
F2 (t)	● 186	192	192	189	189	190	190	191	182	184
	■ 299	306	309	304	309	312	310	315	319	316
F3 (t)	● 120	122	121	115	117	117	114	115	105	105
	■ 243	246	248	241	248	249	245	249	252	247
↕ (m) D50	63,3	57,6	57,6	57,6	57,6	57,6	57,6	57,6	57,6	57,6
↕/P+ (m) D50	63,3	57,6	57,6	57,6	57,6	57,6	57,6	57,6	57,6	57,6

2,5 m - Y 80A - C50										
▲▼▲ (m)	35	40	45	50	55	60	65	70	75	80
↕ (m)	58,1	58,1	58,1	63,8	58,1	63,8	63,8	63,8	63,8	63,8
↕/P+ (m)	58,1	58,1	58,1	63,8	58,1	63,8	63,8	63,8	63,8	63,8
⌘	11,2 m	1	1	1	1	1	1	1	1	1
	5,78 m	7	7	7	8	7	8	8	8	8
F1 (t)	● 95	98	98	108	97	108	109	110	106	104
	■ 104	107	108	128	108	133	131	134	136	133
↕ (m) D50	52,3	52,3	52,3	52,3	52,3	52,3	52,3	52,3	52,3	52,3
↕/P+ (m) D50	52,3	52,3	52,3	52,3	52,3	52,3	52,3	52,3	52,3	52,3

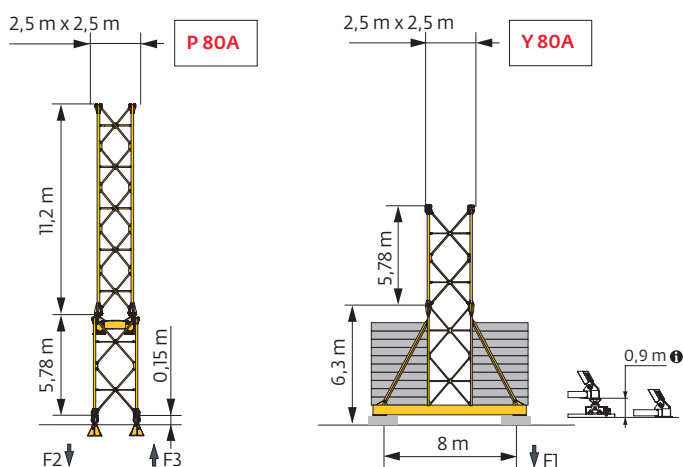

**i** Accès motorisés : compositions de mâture, de lest de base et réactions adaptées. / Motorisierter Zugang vom Mastzusammensetzung, Grundballast und Reaktionskräfte sind angepasst. / Motorized accesses: adapted mast composition, base ballast and reactions. / Acceso a cabina con elevador: Adaptación de composición de mástil, lastre de base y reacciones. / Accessi motorizzati: composizioni elementi torre, zavorre di base e reazioni aggiornate. / Acessos motorizados: composições de coluna, lastro da base e reações adaptadas. / Лифты : адаптированная композиция мачты, базовый балласт и нагрузки.

Ancrages / Verankerungen / Anchorages / Anclajes / Ancoraggi  
Ancoragem / нкрепа

**i**

Lest de base / Grundballast / Base ballast / Lastre de base / Zavorra di base  
 Lastro da base / Базовый Балласт

**⚖️(t) / 📏2,45 m - JM 850 - 🏗️ - C50**

📏 (m)	35	40	45	50	55	60	65	70	75	80
82,8	216				216					
81,1	216	216	216	204	216	216	204	204	216	204
76,1	180	168	168	156	168	168	156	168	168	156
71,1	144	132	132	132	132	132	132	132	132	120
66,1	108	108	108	96	108	108	96	96	96	96
61,1	84	72	72	60	72	72	60	60	72	60
56,1	48	48	48	48	48	48	48	48	48	48
51,1	48	48	48	48	48	48	48	48	48	48
46,1	48	48	48	48	48	48	48	48	48	48
41,1	48	48	48	48	48	48	48	48	48	48
36,1	48	48	48	48	48	48	48	48	48	48
31,1	48	48	48	48	48	48	48	48	48	48
26,1	48	48	48	48	48	48	48	48	48	48
21,1	48	48	48	48	48	48	48	48	48	48

**⚖️(t) / 📏2,45 m - ZX 6830 - 🏗️ - C50**

📏 (m)	35	40	45	50	55	60	65	70	75	80
56,3	171	171	171	161	171	171	161	161	171	161
51,3	131	121	121	121	121	121	121	121	121	131
46,3	111	101	101	101	111	111	111	111	111	111
41,3	101	101	91	91	101	101	111	101	101	101
36,3	101	101	91	91	101	101	101	101	101	101
31,3	101	101	91	91	101	101	101	101	101	101
26,3	101	101	91	91	101	101	101	101	101	101
21,3	101	101	91	91	101	101	101	101	101	101

**⚖️(t) / 📏2,45 m - ZY 800 - 🏗️ - C50**

📏 (m)	35	40	45	50	55	60	65	70	75	80
65,1	156	156	144		144					
63,4	144	144	144	132	144	144	132	132	144	132
58,4	108	108	108	96	108	108	96	96	108	96
53,4	72	72	72	60	72	72	60	60	72	60
48,4	60	48	48	48	60	60	60	60	60	60
43,4	48	48	48	48	60	60	60	60	60	60
38,4	48	48	48	48	60	60	60	60	60	60
33,4	48	48	48	48	60	60	60	60	60	60
28,4	48	48	48	48	60	60	60	60	60	60
23,4	48	48	48	48	60	60	60	60	60	60

**⚖️(t) / 📏2,45 m - ZY 854 - 🏗️ - C50**

📏 (m)	35	40	45	50	55	60	65	70	75	80
73,7	216			216			216	216		
72	216	204	204	204	204	204	204	204	204	192
67	168	168	168	156	168	168	156	168	168	156
62	132	132	132	120	132	132	120	120	132	120
57	96	96	96	84	96	96	84	84	96	84
52	60	60	60	48	48	48	60	48	48	60
47	48	36	36	36	48	48	48	48	48	48
42	36	36	36	36	48	48	48	48	48	48
37	36	36	36	36	48	48	48	48	48	48
32	36	36	36	36	48	48	48	48	48	48
27	36	36	36	36	48	48	48	48	48	48
22	36	36	36	36	48	48	48	48	48	48

**⚖️(t) / 📏2,5 m - Y 80A - 🏗️ - C50**

📏 (m)	35	40	45	50	55	60	65	70	75	80
63,8	96				96	96	96	96	84	
58,1	72	72	72	72	72	72	72	72	72	72
52,3	72	72	72	72	72	72	72	72	72	72
46,5	72	72	72	72	72	72	72	72	72	72
40,7	72	72	72	72	72	72	72	72	72	72
34,9	72	72	72	72	72	72	72	72	72	72
29,2	72	72	72	72	72	72	72	72	72	72
23,4	72	72	72	72	72	72	72	72	72	72

Courbes de charges / Lastkurven / Load curves / Curvas de cargas / Curve di carico / Curvas de carga / Кривые нагрузок



		(m)																								
	20 t	10 t																								
			17	20	25	27	30	35	37	40	45	47	50	55	57	60	65	67	70	72	75	77	80	m		
80	3,7 → 18,7 3,7 → 20,4	33,1 - 37,2 35,7 - 40,1	20	18,5	14,2	12,9	11,4	10	10	9,2	8	7,6	7	6,2	6	5,6	5	4,8	4,5	4,3	4	3,8	3,5	t		
75	3,7 → 20,4 3,7 → 21,2	36,5 - 40,8 38,1 - 42,7	20	20	15,9	14,5	12,8	10,6	10	10	8,9	8,5	7,9	7	6,7	6,3	5,6	5,4	5,1	4,9	4,5	t				
70	3,7 → 22,8 3,7 → 23,5	40,6 - 44,9 42,2 - 46,7	20	20	18	16,5	14,6	12,1	11,3	10,2	9,9	9,5	8,8	7,9	7,5	7,1	6,4	6,1	5,8	t						
65	3,7 → 23,2 3,7 → 23,9	41,1 - 45,5 43,5 - 48	20	20	18,3	16,8	14,8	12,3	11,4	10,4	10	9,6	9	8	7,7	7,2	6,6	t								
60	3,7 → 23,2 3,7 → 23,5	41,4 - 45,1 42,4 - 46,6	20	20	18,4	16,8	14,8	12,3	11,5	10,4	10	9,6	9	8	7,7	7,2	t									
55	3,7 → 23,6 3,7 → 23,6	41,9 - 46,4 42,7 - 47	20	20	18,7	17,1	15,1	12,5	11,7	10,6	10	9,9	9,2	8,2	t											
50	3,7 → 24,1 3,7 → 24,3	42,7 - 47,2 43,6 - 48,2	20	20	19,1	17,5	15,4	12,8	12	10,9	10	10	9,4	t												
45	3,7 → 23,9 3,7 → 23,9	42,4 - 45 42,4 - 45	20	20	18,9	17,3	15,2	12,6	11,8	10,7	10	t														
40	3,7 → 24,3 3,7 → 24,3		20	20	19,3	17,6	15,5	12,8	12	10,9	t															
35	3,7 → 24,3 3,7 → 24,3		20	20	19,3	17,7	15,6	12,8	t																	

= - 1,52 t max.



		(m)																								
	20 t	10 t																								
			17	20	25	27	30	35	37	40	45	47	50	55	57	60	65	67	70	72	75	77	80	m		
80	2,5 → 19,2 2,5 → 20,9	34,6 - 35,6 37,2 - 38,4	20	19,1	14,8	13,5	11,9	10	9,6	8,7	7,5	7,1	6,5	5,7	5,4	5	4,5	4,3	4	3,8	3,5	3,3	2,95	t		
75	2,5 → 20,9 2,5 → 21,7	38,2 - 39,4 39,9 - 41,2	20	20	16,5	15,1	13,4	11,1	10,4	9,8	8,5	8,1	7,5	6,6	6,3	5,8	5,2	4,9	4,6	4,4	4,1	t				
70	2,5 → 23,3 2,5 → 24	42,5 - 43,7 44,2 - 45,5	20	20	18,5	17	15,1	12,6	11,8	10,8	9,7	9,2	8,5	7,5	7,2	6,7	6,1	5,8	5,5	t						
65	2,5 → 23,8 2,5 → 24,5	43 - 44,3 45,6 - 46,7	20	20	18,9	17,3	15,3	12,8	12	10,9	9,8	9,3	8,6	7,7	7,4	6,9	6,2	t								
60	2,5 → 23,8 2,5 → 24,1	43,3 - 43,9 44,4 - 45,3	20	20	18,9	17,4	15,4	12,9	12,1	11	9,7	9,3	8,6	7,7	7,4	6,9	t									
55	2,5 → 24,2 2,5 → 24,2	43,9 - 45,1 44,7 - 45,8	20	20	19,3	17,7	15,7	13,1	12,3	11,2	10	9,5	8,8	7,9	t											
50	2,5 → 24,6 2,5 → 24,8	44,6 - 46 45,6 - 46,8	20	20	19,7	18	16	13,4	12,5	11,4	10	9,7	9	t												
45	2,5 → 24,5 2,5 → 24,5	44,4 - 45 44,4 - 45	20	20	19,5	17,8	15,8	13,2	12,3	11,3	10	t														
40	2,5 → 24,9 2,5 → 24,9		20	20	19,9	18,2	16,1	13,4	12,5	11,4	t															
35	2,5 → 24,9 2,5 → 24,9		20	20	19,9	18,2	16,2	13,4	t																	

= - 0,45 t max.

Poids de flèche & lest de contre-flèche / Auslegergewicht & Gegenauslegerballast / Jib weight & counter-jib ballast / Peso de flecha y lastre de contra-flecha/Peso del braccio & zavorra di contro-braccio/Peso da lança & lastro da contra lança/Вес стрелы и балласт контр-стрелы



	(kg) (+/- 5%)			100 LVF / 110 HPL™			150 HPL™ GH		
				6000 kg	4000 kg	(kg)	6000 kg	4000 kg	(kg)
80 m	19730	19280	20270	5	0	30000	3	2	26000
75 m	19095	18645	19635	4	1	28000	3	1	22000
70 m	18930	18480	19470	4	1	28000	3	1	22000
65 m	18200	17750	18740	3	2	26000	2	2	20000
60 m	17110	16660	17650	3	1	22000	2	1	16000
55 m	16385	15935	16925	2	2	20000	1	2	14000
50 m	15840	15390	16380	3	2	26000	2	2	20000
45 m	15115	14665	15655	3	1	22000	2	1	16000
40 m	14130	13680	14670	2	2	20000	1	2	14000
35 m	13005	12555	13545	2	1	16000	1	1	10000

CBC - 6000 kg

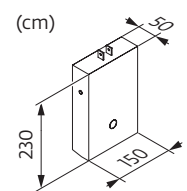
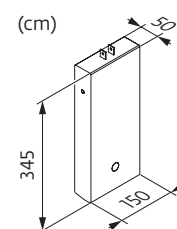









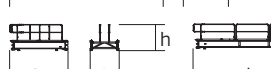
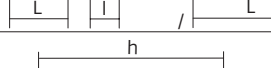
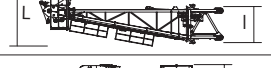









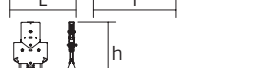

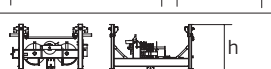

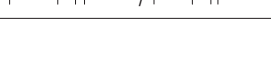
CBD - 4000 kg











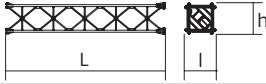
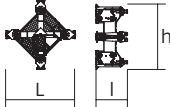

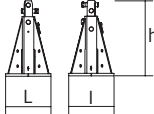
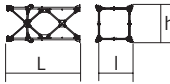
Encombremet et poids / Abmessungen und Gewicht / Dimensions and weight / Dimensiones y peso / Ingombro e peso  
dimensões e pesos / габаритные размеры и вес

Partie tournante / Drehender Kranteil / Slewing crane part / Parte giratoria  
Parte rotante / Parte rotativa / Поворотная часть :  80 m -  100 LVF

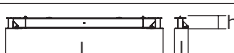
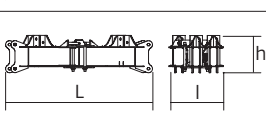

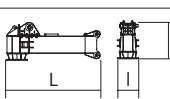
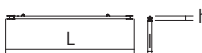
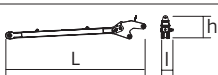
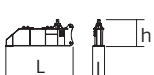
Partie tournante / Drehender Kranteil / Slewing crane part Parte giratoria / Parte rotante / Parte rotativa / Поворотная часть	L (m)	l (m)	h (m)	kg (+/- 5%)		
Contre-flèche / Gegenausleger Counter-jib / Contra-flecha Controbraccio / Contra-lança Контр-стрела		10,8	3,1	1,7	3765	
		3,7	1,89	1,7	985	
		8,2	1,89	1,7	2075	
Porte-flèche / Auslegerträger Cathead / Porta-flecha Cuspide / Suporte de lança Оголовок		4,2	2,24	11,8	7495	
Cabine / Kabine Cab / Cabina Cabina / Cabina Кабина	 Ultra View	5,04	2,24	2,51	1680	
Pivot / Krankopf Towerhead / Pivote Portaralla / Pivot Секция поворотной части		$\nabla$ 2,45 m $\nabla$ 2,5 m	3,81	4,26	2,96	9230
			3,81	4,26	2,65	8530
Treuil de levage (+ câble) / Hubwerk (+ Seil) Hoisting winch (+ rope) / Mecanismo de elevación (+ cabo) Argano di sollevamento (+ fune) Guincho de elevação (+ cabo) Подъемная лебедка (+ канатом)		100 LVF	3,18	1,6	1,88	4455
		110 HPL™	3,78	1,85	1,88	5860
		150 HPL™ GH	4,82	1,93	1,97	8745
Elément de flèche / Auslegerelement Jib section / Elemento de flecha Elemento di braccio / Elemento de lança Секция стрелы		①	10,28	2,02	2,37	3205
		② 10 DVF	10,27	1,9	2,25	3730
		④	10,24	1,9	2,23	2145
		⑤	10,23	1,9	2,22	1815
		⑨	10,17	1,9	1,99	1270
Elément de flèche / Auslegerelement Jib section / Elemento de flecha Elemento di braccio / Elemento de lança Секция стрелы		③	5,35	1,9	2,27	1450
		⑥	5,23	1,9	2,22	990
		⑦	5,21	1,9	2,23	1125
		⑧	5,2	1,9	2	730
Chariot + Moufle / Laufkatze + Hubflasche Trolley + Pulley block / Carrello + Aparejo Carro + Bozzello / Carro-distribuidor + Cadernal Тележка + Полиспаст			1,8	2,23	1,62	660
		20 t	1,18	0,44	2,26	880
Chariot / Laufkatze Trolley / Carrello Carro / Carro-distribuidor Тележка			4,1	2,19	1,16	1195
		20 t				
Chariot / Laufkatze Trolley / Carrello Carro / Carro-distribuidor Тележка			2,14	2,19	1,16	645
		10 t				
Moufle / Hubflasche Pulley block / Aparejo Bozzello / Cadernal Полиспаст			1,83	0,34	2,23	885
		20 t	1,17	0,22	1,77	445
		10 t				
<b>Pylône / Kranturm / Crane tower Mástil / Torre / Torre / Башня крана</b>						
T 851		$\nabla$ 2,45 m	11,18	4,84	5,8	15750

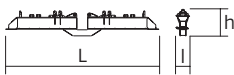
		L (m)	l (m)	h (m)	kg (+/- 5%)	
Coulisse / Gleitstück Slider / Corredera Scorrimento / Tramo interior de telescopagem выдвигная мачта		2,5				
		11,08	2,1	2,1	7100	
Bas de coulisse / Gleitstückunterteil Slider base / Parte baja de corredera Parte inferiore di scorrimento Base do tramo interior de telescopagem основание выдвигной мачты		2,5				
		2,35	1,58	2,35	5960	
K 85/KR 84B2 KM 850.10B KM 850.14B K 849A KMT 849A KRMT 849A KR 849A K 85/KR 84A2 KMT 850.10A KMT 850.14A KRMT 849C		2,45				
		10,24 10,32 10,32 5,23 5,23 5,23 5,24 5,32 5,32 3,57	2,54 2,54 2,54 2,53 2,55 2,55 2,54 2,54 2,54 2,55	2,5 2,51 2,51 2,5 2,53 2,53 2,5 2,5 2,51 2,51 2,53	9635 10070 11190 3400 3150 4090 4290 5550 5450 5990 3205	
R 87 R 86 R 85		2,5				
		6,4 6,4 6,4	2,9 2,9 2,9	2,9 2,9 2,9	4260 3820 3700	
Pieds de scellement / VerankerungsfüÙe Fixing angles / Pie de empotramiento Montante da anngare / Angulos fixadores анкера						
			P 800B P 854A P 80A	0,75 0,9 0,8	1,28 1,5 1,21	465 940 1970
Mât-châssis / Grundmasteinheit Basic mast unit / Tramo-chasis Elemento base / Tramo-chassis Мачта для крепления к шасси						
		Y 80A	6	3	3	7400
Haubans / Mastabstützungen / Struts / Tornapuntas Puntoni / Escoras / Растяжка						
		Y 80A	5,48	0,42	0,37	800
1/2 Longeron / 1/2 Längsträger / 1/2 Side member / 1/2 Larguero 1/2 Longherone / 1/2 Longarina / 1/2 боковина						
		Y 80A	5,62	1,17	0,6	1000
Longeron / Längsträger / Side member / Larguero Longherone / Longarina / боковина						
		Y 80A	11,86	1,17	0,6	2100
Support lest / Ballasträger / Ballast support / Soporte de lastre Supporto zavorra / Suporte de lastro / Опора балласта						
		Y 80A	4,65	0,32	0,66	270
Traverse de châssis / Unterwagentraverse / Chassis beam Traviesa chasis / Traversa carro / Travessa chassis / балка шасси						
		Y 80A	8,6	0,7	1,15	2000
Croix centrale (position transport) / Zentralkreuz (Transport- position) / Central cross (transport position) / Brazo central (posición transporte) / Croce centrale (posizione di trasporto) Braço central chassis (posição transporte) / крестообразное основание (транспортное положение)						
		JM 850	5,2	1,7	1,5	6700
Mât-châssis / Grundmasteinheit Basic mast unit / Tramo-chasis Elemento base / Tramo-chassis Мачта для крепления к шасси						
		JM 850	8,75	2,5	2,5	14600
Bras de châssis / Unterwagenträger / Chassis girder / Brazo de base en cruz / Traverse del carro / Braço de chassis / опорная балка шасси						
		JM 850	5,2	0,9	1,55	3200
Tirant de châssis / Unterwagenstreben / Chassis ties / Tirante de base en cruz / Tiranti del carro / Tirante de chassis / тяга крепления шасси						
		JM 850	7,2	0,25	0,35	250
Haubans / Mastabstützungen Struts / Tornapuntas Puntoni / Escoras / Растяжка						
		JM 850	8,2	0,75	1,3	2300
1/2 Bras de croix / 1/2 Fundamentkreuzträger 1/2 Cross girder / 1/2 Brazo en cruz 1/2 Braccio croce / 1/2 Braço da cruz 1/2 Поперечная балка						
		ZY 800 ZY 854	5,68 5,66	0,98 0,98	1,92 2,27	4720 5940
Bras de croix / Fundamentkreuzträger Cross girder / Brazo en cruz Braccio croce / Braço da cruz Поперечная балка						
		ZY 800 ZY 854	11,96 11,9	1,39 1,42	1,92 2,27	10075 13350
						
			9,1	1,12	1,1	5265
						
		ZX 6830	9,1	0,76	1,48	5445

Mécanismes / Triebwerke / Mechanisms / Mecanismos / Meccanismi  
 Mecanismos / Механизмы

400 V - 50 Hz												ch - PS hp	kW		
	<b>100 LVF 50 Optima</b>	m/min	36,5	46,5	61,5	78,5	94	18,5	24	32	44,5	47	100	75	1018 m
		t	10	7,5	5	2,5	1,25	20	15	10	5	3,9			
	<b>110 HPL™ 50</b>	m/min	42	54,5	76	115	172,5	21	27,5	39	59	93			
	<b>150 HPL™ 50 GH</b>	m/min	55	68,5	92,5	144	195	28	35	48,5	80	97,5	150	110	1200 m
		t	10	7,5	5	2,5	0,8	20	15	10	5	3			
	<b>10 DVF 10 Optima</b>	m/min	0 → 80 (20 t) 0 → 100 (12,5 t) 0 → 110 (6,3 t)									10	7,4		
	<b>RVF 173 Optima+</b>	tr/min U/min rpm	0 → 0,8									3 x 10	3 x 7,5		

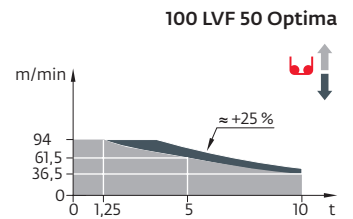

	<b>IEC 60204-32</b>		<b>kVA</b>
400 V (+10% -10%) 50 Hz		100 LVF : 117 → 77 kVA 110 HPL™ : 125 → 81 kVA 150 HPL™ GH : 157 → 97 kVA	

	<b>FR</b>	<b>DE</b>	<b>EN</b>	<b>ES</b>	<b>IT</b>	<b>PT</b>	<b>RU</b>
	Profil de vent suivant EN 14439 C50-D50	Windbedingungen gemäss EN 14439 C50-D50	Wind conditions according to EN 14439 C50-D50	Conformidad de los condiciones de viento EN 14439 C50-D50	Condizioni del vento secondo EN 14439 C50-D50	Perfil de vento conforme EN 14439 C50-D50	Ветровой режим в соответствии с EN 14439 C50-D50
	Équipements standards	Standardausrüstungen	Standard equipment	Equipamiento de serie	Equipaggiamento standard	Equipamento de série	Стандартное оборудование
	Équipements optionnels	Sonderausrüstungen	Options	Equipamiento opcional	Equipaggiamento in opzione	Equipamento opcional	Дополнительное оборудование (опция)
	Fonction Potain Plus : Courbes de charges Plus	Funktion Potain Plus: Plus-Lastkurven	Potain Plus function: Plus load curves	Función Potain Plus: Diagrama de cargas Plus	Funzione Potain Plus: Curve di carico Plus	Função Potain Plus: Diagrama de cargas Plus	Функция контроля мощности Potain Plus: Диаграммы грузоподъемности Plus
	Hauteurs sous crochet associées aux courbes de charges Plus	Hakenhöhen mit Plus-Lastkurven	Hook heights with Plus load curves	Altura bajo gancho, usando el diagrama de cargas Plus	Altezze sotto gancio con curve di carico Plus	Altura livre, utilizando o diagrama de cargas Plus	Высота под крюком для диаграмм грузоподъемности Plus
	Réactions en service	Reaktionskräfte in Betrieb	Reactions in service	Reacciones en servicio	Reazioni in servizio	Reacções em serviço	Реакция при работе
	Réactions hors service	Reaktionskräfte außer Betrieb	Reactions out of service	Reacciones fuera de servicio	Reazioni fuori servizio	Reacções fora de serviço	Реакция в покое
	Poids total du lest	Ballast-Gesamtgewicht	Total ballast weight	Peso total del lastre	Peso totale della zavorra	Peso total do lastro	Общий вес балласта
	Poids de flèche	Auslegergewicht	Jib weight	Peso de flecha	Peso del braccio	Peso da lança	вес стрелы
	Camion 13,4 m	Lkw 13,4 m	Lorry 13,4 m	Camión 13,4 m	Camion 13,4 m	Camião 13,4 m	Рзуровой автомобиль 13,4 м
	Conteneur High Cube 40', et/ou Flat Rack 20'	Container High Cube 40', und/oder Flat Rack 20'	Container High Cube 40', and/or Flat Rack 20'	Contenedor High Cube 40', y/o Flat Rack 20'	Container High Cube 40', e/o Flat Rack 20'	Contentor High Cube 40', e/ou Flat Rack 20'	40-футовый контейнер повышенной вместимости High Cube, и/или 20-футовая открытая платформа Flat Rack
	Levage	Heben	Hoisting	Elevación	Sollevamento	Elevação	Подъем
	Distribution	Katzfahren	Trolleying	Distribución	Ditribuzione	Distribuição	Перемещение по стреле
	Orientation	Schwenken	Slewing	Orientación	Rotazione	Rotação	Поворот
	Translation	Kranfahren	Travelling	Traslación	Traslazione	Translação	Перемещение крана
	Puissance requise	Erforderliche Leistung	Required power	Potencia Necesaria	Potenza richiesta	Potência Necessária	Потребляемая мощность
	Fonction Power Control : vitesses treuils adaptées à la puissance disponible	Funktion Power Control: Geschwindigkeiten der Triebwerke werden an die verfügbare Leistung angepasst	Power Control Function: winch speeds adapted to the available power	Función Power Control: marchas de los cabrestantes adaptadas a la potencia disponible	Funzione Power Control: velocità degli argani adattate alla potenza disponibile	Função Power Control: velocidades de guincho adaptadas à potência disponível	Функция контроля мощности Power Control: регулировка скорости лебедок в зависимости от доступной мощности
	Nous consulter	Auf Anfrage	Consult us	Consultarnos	Consultateci	Consultar-nos	Проконсультируйтесь у нас
	Document commercial non contractuel. Pour toute information technique se référer à la notice correspondante.	Unverbindliches Vertriebsdokument. Für technische Informationen, siehe die entsprechenden Anweisungen.	This commercial document is not legally binding. For any technical information, please refer to the corresponding instructions.	Documento comercial no contractual. Para cualquier información técnica, ver la noticia correspondiente.	Documento commerciale non vincolante, per tutte le informazioni tecniche fare riferimento al catalogo istruzioni.	Documento comercial não contratual. Para qualquer informação técnica complementar consultar as respectivas instruções.	Этот коммерческий документ не является юридически обязательным. Для получения технической информации, см. соответствующие инструкции.

