

NATIONAL CRANE®

NBT50L Series Product Guide

ASME B30.5 • Imperial 85%



Features

- NBT50L: 45,4 t (50 USt)
- NBT55L: 49,9 t (55 USt)
- 46 m (151 ft) five-section, full-power boom
- 11 m (36 ft) lattice, offsettable jib
- Hydraulically removable counterweight system with multiple configurations
- Hydraulically tilting operator cab
- NTC Performance Package (NTC50L/NTC55L)

NATIONAL CRANE NBT50L SERIES

Introducing the NBT50L, NBT55L and NTC55L: The next evolution of the proven NBT50 Series taking you to new heights.

Features

> Five-section boom

The NBT50L Series is equipped with a 46 m (151 ft) boom. An optional 11 m (36 ft) fixed length offsettable jib and a 7,9 m to 13,7 m (26 ft to 45 ft) two-section offsettable manual extension is available.

> Extreme versatility and strength

The NBT50L Series offers three product configurations based on the successful NBT50 Series including both 45,4 t (50 USt) and 49,9 t (55 USt) capacities.

> Operator-focused design

The NBT50L Series is designed specifically with the operator in mind, with up to 20° cab tilt, a graphical RCL with integrated control system, optional side-view and hoist-view cameras, optional dual axis electronic joysticks and lighter polymeric outrigger floats for easy setup.

> NTC Performance Package

National Crane truck crane features the easy roadability of a boom truck. The NTC Performance Package provides key features such as four-position outriggers (100%, 75%, 50% and fully retracted charts), integrated two-camera system for hoist-view and rearviews, and built-in wireless windspeed indicator. NTC Performance Package machines come with special NTC50L and NTC55L model designations.

> Options and Customizations

The NBT50L Series can be enhanced with these factory options and Lift Solutions to tailor to your needs. See the Truck Mod Customization Catalog for additional turn-key options.

- Factory-installed toolbox, pintle hitches, outrigger cribbing mats
- Wireless anti-two-block system
- Radio remote controls
- Wind speed indicator
- Hoist-view and sideview camera system



Jobsite benefits

- Long reach and solid crane foundation.
 - 49,1 m (161 ft) working height without needing to swing a jib. If additional reach is needed, two jib options are available in the 11 m (36 ft) lattice offsettable jib and the manual two-section 7,9 m to 13,7 m (26 ft to 45 ft) telescoping jib to a working height over 61 m (200 ft).
 - Four outrigger positions, including a unique 6,1 m (20 ft) span for tight operating spaces (similar to 40 USt truck cranes)
 - Rock-solid operating performance with less carrier flex and twist than an average boom truck
 - Hydraulically self-removable counterweight with multiple slabs for easy roading
- Simpler, smoother and smarter operation.
 - Graphical RCL for easy setup
 - Class-leading features, such as adjustable joystick speeds, onboard diagnostics, and service capabilities without the need for a laptop
 - Offsettable jib options
- Enhanced comfort, access and egress, and setup.
 - Comfort of a commercial truck chassis from leading manufacturers
 - 20° hydraulically tilting, ergonomic operator cab
 - Strong aluminum decking with multiple ladders for easy access
 - Lighter polymeric operator floats that are easy to use and less prone to theft on the job
 - Easy-access hydraulics for maintenance and increased serviceability



What you need, when you need it.

Get right to work with the right equipment — Manitowoc Finance gives you access to flexible, affordable financing you can use to seize profitable new opportunities as they arise.

Feel confident in your investment — rest easy with the assurance of the world's most advanced crane service and support network.

Contents

Dimensions and weights 5–6

Mounting configurations 7

Working range 8, 17

Load charts 9–16, 18–21

Specifications 22–25

Symbols glossary 26

Dimensions

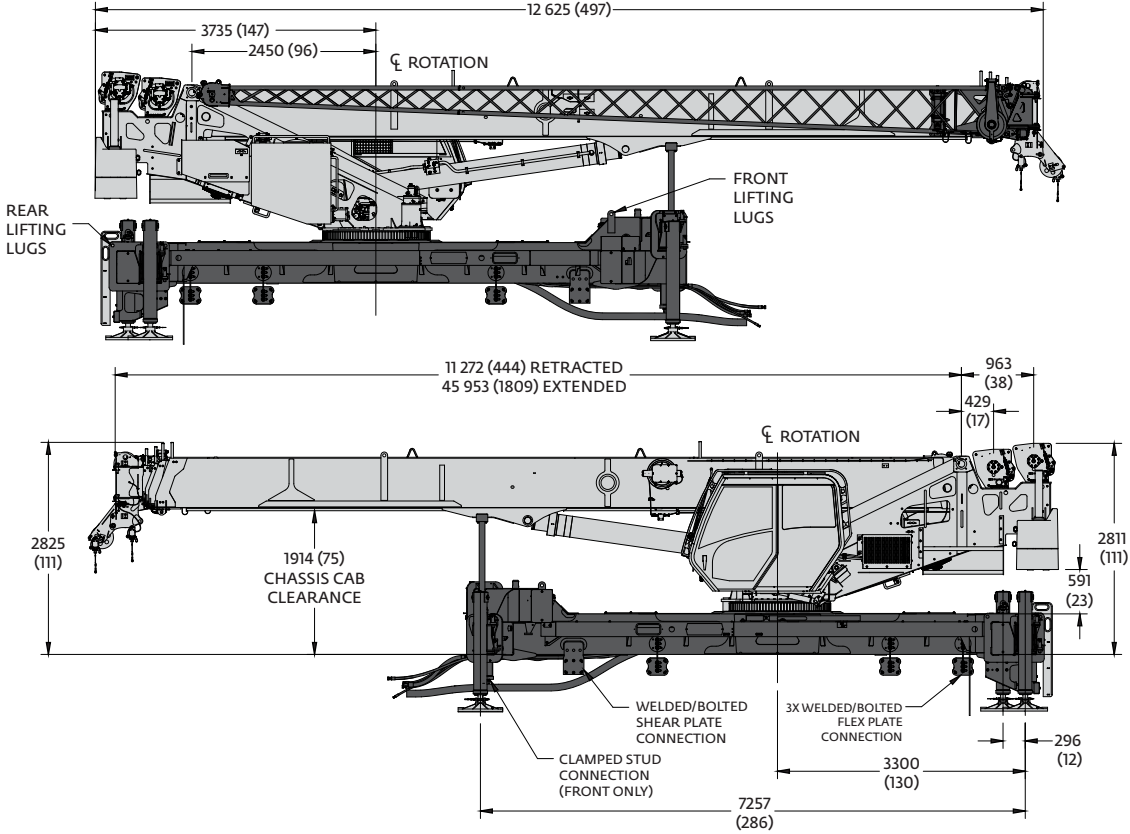

Dimensions are in mm (in) unless otherwise specified

Note: 75% span available ONLY with the NTC Performance Package.

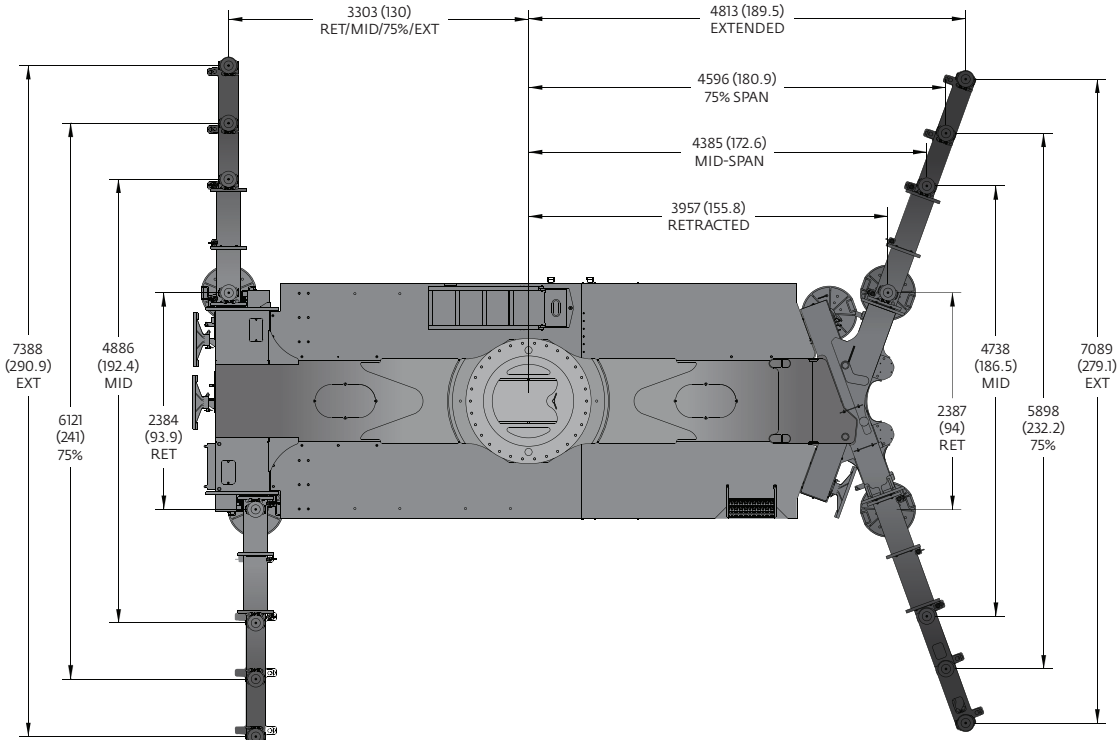

Dimensions

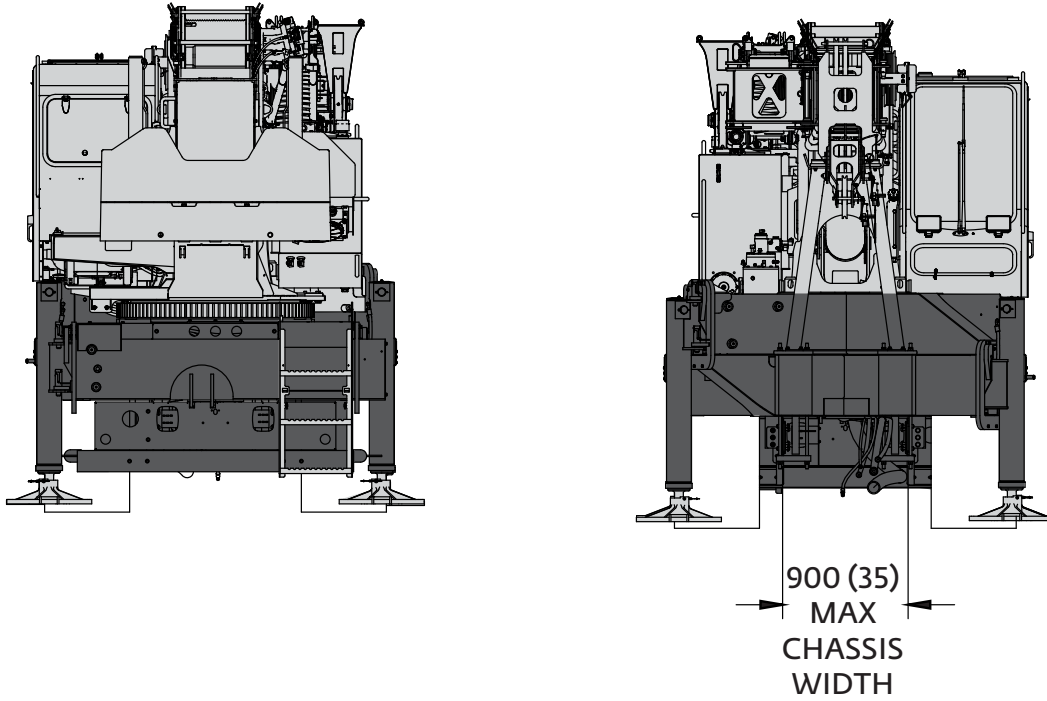

Dimensions are in mm (in) unless otherwise specified

Weight and CG Estimates			
Configuration	Horizontal CG mm (in)	Weight w/ Fluids kg (lb)	CWT Pinned kg (lb)
NBT50L/NTC50L	895 (35.25)	21 907 (48,297)	680 (1500)
NBT50L/NTC50L	762 (30)	22 589 (49,800)	1361 (3000)
NBT55L/NTC55L	520 (20.5)	23 953 (52,807)	2722 (6000)

Mounting configurations

The configurations are based on the NBT50L Series with an 85% stability factor. The complete unit must be installed in accordance with factory requirements and a test performed to determine actual stability and counterweight requirements since individual truck chassis vary.

NBT50L, NBT55L and NTC55L Recommended Minimum Truck Specification

Working area: 360°

Gross Axle Weight Rating Front: 9072 kg (20,000 lb)

Gross Axle Weight Rating Rear: 28 122 kg (62,000 lb)

Wheelbase: 708 cm (279 in)

Cab to Axle/trunnion (CA/CT): 488 cm (192 in)

Frame Strength: 785 MPa (110,000 PSI)

Frame Section Modulus (SM),
front axle to end of AF: 327 cm³ (20 in³)

Stability Weight, Front: 4355 kg (9600 lb) minimum

Stability Weight, Rear: 4609 kg (10,160 lb) minimum

NOTE: Estimated axle scale weights prior to installation of crane assembly for 85% stability. This configuration does not meet Federal Bridge Law.

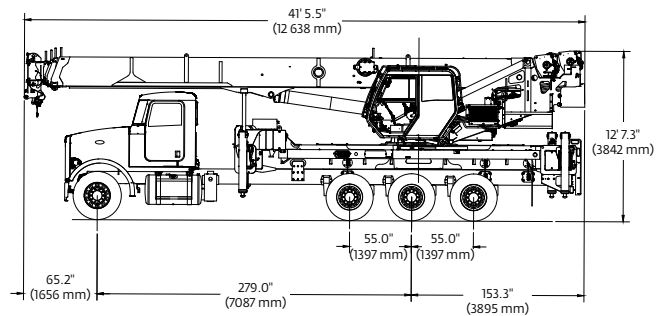

Minimum truck requirements

Many factors must be considered in the selection of proper truck for an NBT50L Series crane. Items which must be considered are:

1. Axle Rating. Axle ratings are determined by the axles, tires, rims, springs, brakes, steering and frame strength of the truck. If any one of these components is below the required rating, the gross axle rating is reduced to its weakest component value.

2. Wheelbase (WB), Cab-to-Trunnion (CT) and Bare Chassis Weight. The wheelbase, CT and chassis weights shown are required so the basic NBT50L Series can be legally driven in most states and meet stability requirements. The dimensions given assume the sub-base is installed properly behind the truck cab. If exhaust stacks, transmission protrusions, etc., do not allow a close installation to the cab, the WB and CT dimensions must be increased. Refer to the Mounting Configuration pages for additional information.

3. Truck Frame. Try to select a truck frame that will minimize or eliminate frame reinforcement or extension of the after frame (AF). Many frames are available that have the necessary AF section modulus (SM) and resistance to bending moment (RBM) so that reinforcing is not required. The front hydraulic jack is used for a

360° working range around the truck. The frame under the cab through the front suspension must have the minimum SM and RBM because reinforcing through the front suspension is often difficult because of engine, radiator mounts and steering mechanics. See Truck Requirements and Frame Strength pages for the necessary SM and RBM values. Integral extended front frame rails are required for front center stabilizer installation.

4. Additional Equipment. In addition to the axle ratings, wheelbase, cab-to-axle requirements and frame, it is recommended that the truck is equipped with electronic engine control, increased cooling and a transmission with a PTO opening available with an extra heavy-duty PTO. A conventional cab truck should be used for standard crane mounts.

5. Neutral Start Switch. The chassis must be equipped with a switch that prevents operation of the engine starter when the transmission is in gear.

Notes:

Gross Vehicle Weight Rating (GVWR) is dependent on all components of the vehicle (axles, tires, springs, frame, etc.) meeting manufacturers' recommendations; always specify GVWR when purchasing trucks

Diesel engines require a variable speed governor for smooth crane operation; electronic fuel injection requires EET engine remote throttle

All mounting data is based on a National Crane NBT50L Series with an 85% stability factor.

The complete unit must be installed in accordance with factory requirements, and a test performed to determine actual stability and counterweight requirements per SAE J765; contact the factory for details.

Working range



46,0 m (151 ft)



11 m (36 ft)



100%



360°

Boom deflection not shown

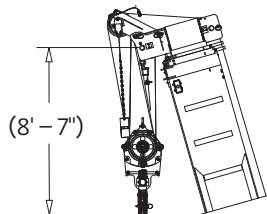
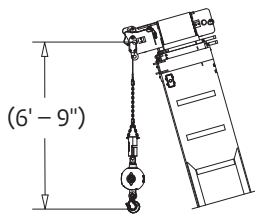
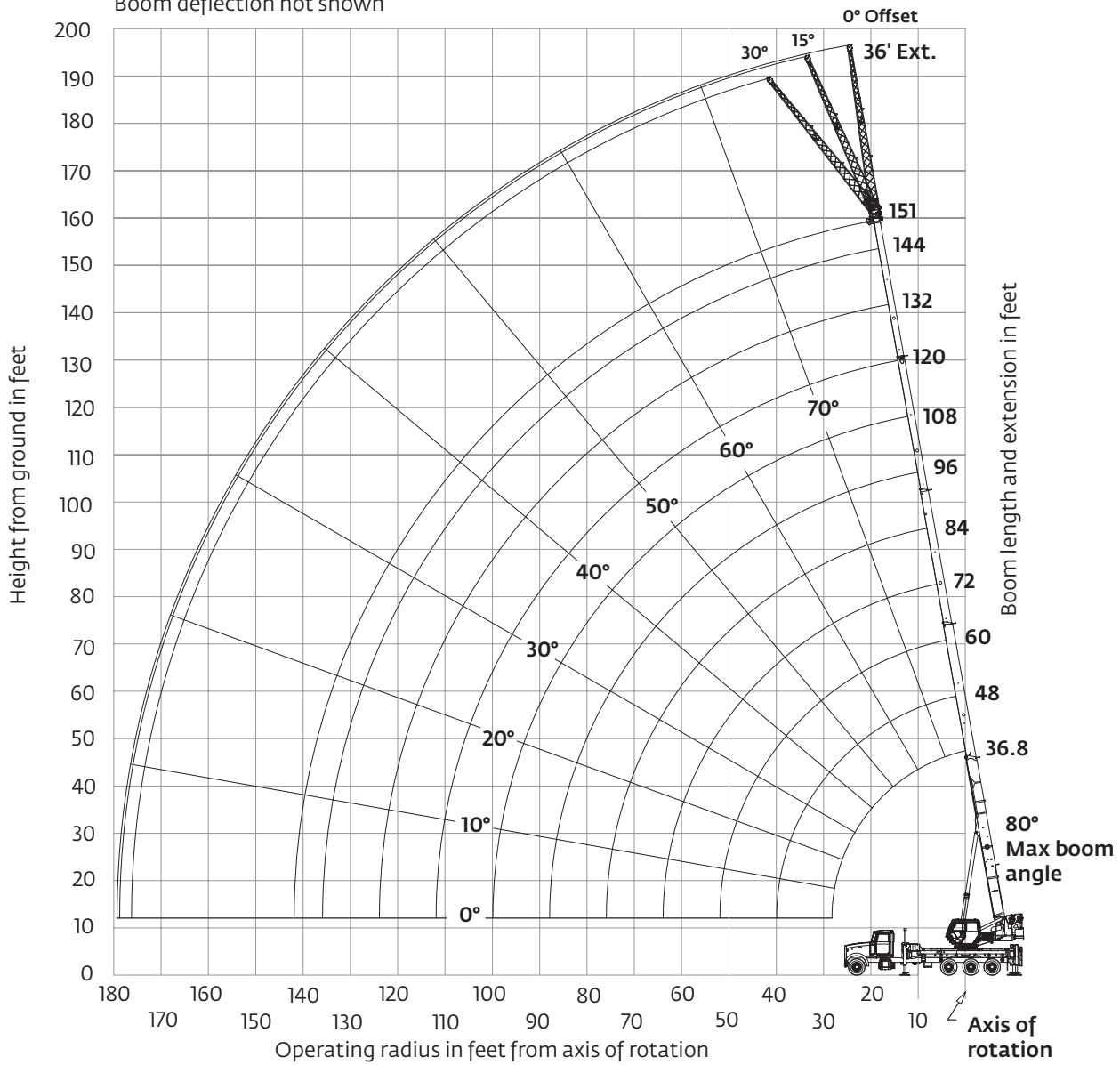

Dimensions are for largest furnished hook block and headache ball with anti-two-block activated.

* This drawing shows the physical reach of the machine. Always refer to load chart to see which portions of this diagram are valid for the specific machine configuration and where the loads are structurally or stability limited.

Load charts

NBT55L/NTC55L



11 m – 46 m (36 ft – 151 ft)



2722 kg (6000 lb)



100%



360°



Pounds

Radius in Feet	Main Boom Length in Feet											
	36.8	48	60	72	84	96	108	120	132	144	151	
6	110,000 (71.5)	41,500 (76.7)	—	—	—	—	—	—	—	—	—	—
8	106,500 (68)	41,500 (74.2)	41,500 (78.2)	—	—	—	—	—	—	—	—	—
10	93,200 (64.4)	41,500 (71.6)	41,500 (76.2)	41,500 (79.4)	—	—	—	—	—	—	—	—
12	82,600 (60.7)	41,500 (69)	41,500 (74.2)	41,500 (77.8)	—	—	—	—	—	—	—	—
15	70,150 (54.9)	41,500 (64.9)	41,500 (71.1)	41,500 (75.3)	39,700 (78)	33,200 (79.9)	—	—	—	—	—	—
20	55,100 (43.7)	41,500 (57.8)	41,500 (65.8)	41,500 (71)	36,100 (74.5)	30,250 (77)	23,550 (79.3)	—	—	—	—	—
25	37,200 (28.9)	41,500 (49.9)	41,500 (60.3)	38,150 (66.7)	32,950 (71)	27,400 (74.1)	21,150 (76.7)	18,600 (78.9)	—	—	—	—
30	—	32,650 (40.5)	33,400 (54.3)	33,850 (62.1)	30,250 (67.4)	24,700 (71.1)	19,100 (74.2)	16,950 (76.7)	14,500 (78.4)	11,300 (79.9)	—	—
35	—	26,200 (28.5)	26,950 (47.6)	27,450 (57.2)	27,700 (63.6)	22,350 (68)	17,250 (71.5)	15,450 (74.3)	13,900 (76.4)	11,300 (78)	10,050 (78.8)	10,050 (78.8)
40	—	—	21,350 (39.6)	22,600 (52)	22,300 (59.5)	20,300 (64.8)	15,700 (68.8)	14,150 (72)	12,800 (74.3)	11,300 (76.1)	10,050 (77)	10,050 (77)
45	—	—	17,050 (30)	18,300 (46.1)	18,050 (55.3)	17,750 (61.4)	14,350 (66.1)	12,950 (69.6)	11,750 (72.1)	10,700 (74.2)	10,050 (75.2)	10,050 (75.2)
50	—	—	13,050 (15.5)	14,950 (39.2)	14,800 (50.7)	14,850 (57.8)	13,200 (63)	11,900 (67.1)	10,850 (70)	9930 (72.3)	9470 (73.4)	9470 (73.4)
55	—	—	—	12,250 (31.1)	12,250 (45.2)	12,550 (54)	12,150 (59.8)	11,000 (64.4)	10,000 (67.8)	9200 (70.3)	8780 (71.5)	8780 (71.5)
60	—	—	—	10,000 (20.4)	10,050 (39.1)	10,650 (49.9)	10,500 (56.5)	10,150 (61.5)	9300 (65.4)	8540 (68.3)	8160 (69.6)	8160 (69.6)
65	—	—	—	—	8490 (32)	9090 (44.8)	8930 (53)	9450 (58.5)	8640 (62.8)	7940 (66.2)	7590 (67.7)	7590 (67.7)
70	—	—	—	—	7080 (23.3)	7760 (39.2)	7610 (48.9)	8160 (55.4)	7870 (60.2)	7380 (63.9)	7070 (65.6)	7070 (65.6)
75	—	—	—	—	5380 (8.2)	6610 (32.9)	6490 (44.2)	7030 (52.1)	6790 (57.4)	6550 (61.5)	6420 (63.4)	6420 (63.4)
80	—	—	—	—	—	5620 (25.4)	5530 (39.1)	6030 (48.2)	5840 (54.6)	5650 (59.1)	5740 (61.2)	5740 (61.2)
85	—	—	—	—	—	4750 (15)	4550 (33.4)	5140 (43.8)	5010 (51.6)	4880 (56.6)	5100 (58.9)	5100 (58.9)
90	—	—	—	—	—	—	3850 (26.9)	4340 (39.1)	4270 (47.7)	4200 (54)	4490 (56.5)	4490 (56.5)
95	—	—	—	—	—	—	3240 (18.6)	3630 (34)	3610 (43.6)	3590 (51)	3910 (54)	3910 (54)
100	—	—	—	—	—	—	—	2980 (28.1)	2790 (39.2)	2820 (47.4)	3360 (51.1)	3360 (51.1)
105	—	—	—	—	—	—	—	2380 (21.1)	2300 (34.5)	2320 (43.5)	2830 (47.5)	2830 (47.5)
110	—	—	—	—	—	—	—	1840 (10.5)	1870 (29.2)	1890 (39.4)	2320 (43.8)	2320 (43.8)
115	—	—	—	—	—	—	—	—	1480 (23)	1490 (35)	1840 (39.8)	1840 (39.8)
120	—	—	—	—	—	—	—	—	1130 (14.8)	1130 (30.1)	1370 (35.6)	1370 (35.6)
125	—	—	—	—	—	—	—	—	—	810 (24.6)	930 (31)	930 (31)
130	—	—	—	—	—	—	—	—	—	520 (17.7)	500 (25.7)	500 (25.7)

NOTE: () Boom angles are in degrees.

Boom Angle	Main Boom Length in Feet											
	36.8	48	60	72	84	96	108	120	132	144	151	
0°	14,400 (28.3)	10,000 (39.5)	6570 (51.5)	4360 (63.5)	2820 (75.5)	1690 (87.5)	820 (99.5)	—	—	—	—	—

NOTE: () Reference radii in feet.

Load charts

NBT55L/NTC55L



11 m – 46 m (36 ft – 151 ft)



2722 kg (6000 lb)



100%



Over rear



Pounds

Radius in Feet	Main Boom Length in Feet										
	36.8	48	60	72	84	96	108	120	132	144	151
6	110,000 (71.5)	41,500 (76.7)	—	—	—	—	—	—	—	—	—
8	106,500 (68)	41,500 (74.2)	41,500 (78.2)	—	—	—	—	—	—	—	—
10	96,050 (64.4)	41,500 (71.6)	41,500 (76.2)	41,500 (79.4)	—	—	—	—	—	—	—
12	87,300 (60.7)	41,500 (69)	41,500 (74.2)	41,500 (77.8)	—	—	—	—	—	—	—
15	75,400 (54.9)	41,500 (64.9)	41,500 (71.1)	41,500 (75.3)	39,700 (78)	33,200 (79.9)	—	—	—	—	—
20	57,600 (43.7)	41,500 (57.8)	41,500 (65.8)	41,500 (71)	36,100 (74.5)	30,250 (77)	23,550 (79.3)	—	—	—	—
25	37,200 (28.9)	41,500 (49.9)	41,500 (60.3)	38,150 (66.7)	32,950 (71)	27,400 (74.1)	21,150 (76.7)	18,600 (78.9)	—	—	—
30	—	35,300 (40.5)	36,050 (54.3)	34,950 (62.1)	30,250 (67.4)	24,700 (71.1)	19,100 (74.2)	16,950 (76.7)	14,500 (78.4)	11,300 (79.9)	—
35	—	27,200 (28.5)	29,450 (47.6)	29,500 (57.2)	27,950 (63.6)	22,350 (68)	17,250 (71.5)	15,450 (74.3)	13,900 (76.4)	11,300 (78)	10,050 (78.8)
40	—	—	23,700 (39.6)	24,300 (52)	24,450 (59.5)	20,300 (64.8)	15,700 (68.8)	14,150 (72)	12,800 (74.3)	11,300 (76.1)	10,050 (77)
45	—	—	19,250 (30)	20,200 (46.1)	20,050 (55.3)	18,600 (61.4)	14,350 (66.1)	12,950 (69.6)	11,750 (72.1)	10,700 (74.2)	10,050 (75.2)
50	—	—	13,050 (15.5)	16,850 (39.2)	16,650 (50.7)	17,100 (57.8)	13,200 (63)	11,900 (67.1)	10,850 (70)	9930 (72.3)	9470 (73.4)
55	—	—	—	14,100 (31.1)	14,250 (45.2)	14,900 (54)	12,150 (59.8)	11,000 (64.4)	10,000 (67.8)	9200 (70.3)	8780 (71.5)
60	—	—	—	11,750 (20.4)	12,050 (39.1)	12,800 (49.9)	11,250 (56.5)	10,150 (61.5)	9300 (65.4)	8540 (68.3)	8160 (69.6)
65	—	—	—	—	10,250 (32)	11,050 (44.8)	10,450 (53)	9460 (58.5)	8640 (62.8)	7940 (66.2)	7590 (67.7)
70	—	—	—	—	8720 (23.3)	9760 (39.2)	9760 (48.9)	8800 (55.4)	8030 (60.2)	7380 (63.9)	7070 (65.6)
75	—	—	—	—	5380 (8.2)	8330 (32.9)	8480 (44.2)	8210 (52.1)	7460 (57.4)	6840 (61.5)	6550 (63.4)
80	—	—	—	—	—	7230 (25.4)	7350 (39.1)	7570 (48.2)	6840 (54.6)	6260 (59.1)	5980 (61.2)
85	—	—	—	—	—	5920 (15)	5970 (33.4)	6630 (43.8)	6290 (51.6)	5720 (56.6)	5460 (58.9)
90	—	—	—	—	—	—	5190 (26.9)	5770 (39.1)	5560 (47.7)	5240 (54)	4990 (56.5)
95	—	—	—	—	—	—	4520 (18.6)	4970 (34)	4820 (43.6)	4670 (51)	4550 (54)
100	—	—	—	—	—	—	—	4220 (28.1)	4140 (39.2)	4060 (47.4)	4110 (51.1)
105	—	—	—	—	—	—	—	3520 (21.1)	3510 (34.5)	3500 (43.5)	3690 (47.5)
110	—	—	—	—	—	—	—	2430 (10.5)	2940 (29.2)	2990 (39.4)	3260 (43.8)
115	—	—	—	—	—	—	—	—	2400 (23)	2540 (35)	2820 (39.8)
120	—	—	—	—	—	—	—	—	1910 (14.8)	2120 (30.1)	2380 (35.6)
125	—	—	—	—	—	—	—	—	—	1730 (24.6)	1960 (31)
130	—	—	—	—	—	—	—	—	—	1380 (17.7)	1550 (25.7)
135	—	—	—	—	—	—	—	—	—	—	1140 (19.5)
140	—	—	—	—	—	—	—	—	—	—	720 (10.5)

NOTE: () Boom angles are in degrees.

Boom Angle	Main Boom Length in Feet										
	36.8	48	60	72	84	96	108	120	132	144	151
0°	14,400 (28.3)	10,000 (39.5)	6570 (51.5)	4360 (63.5)	2820 (75.5)	1690 (87.5)	820 (99.5)	—	—	—	—

NOTE: () Reference radii in feet.

Load charts

NBT55L/NTC55L and NBT50L/NTC50L



11 m – 46 m (36 ft – 151 ft)



1361 kg (3000 lb)



100%



360°



Pounds

Radius in Feet	Main Boom Length in Feet											
	36.8	48	60	72	84	96	108	120	132	144	151	
6	110,000 (71.5)	41,500 (76.7)	—	—	—	—	—	—	—	—	—	—
8	105,500 (68)	41,500 (74.2)	41,500 (78.2)	—	—	—	—	—	—	—	—	—
10	92,550 (64.4)	41,500 (71.6)	41,500 (76.2)	41,500 (79.4)	—	—	—	—	—	—	—	—
12	82,000 (60.7)	41,500 (69)	41,500 (74.2)	41,500 (77.8)	—	—	—	—	—	—	—	—
15	69,650 (54.9)	41,500 (64.9)	41,500 (71.1)	41,500 (75.3)	39,700 (78)	33,200 (79.9)	—	—	—	—	—	—
20	52,800 (43.7)	41,500 (57.8)	41,500 (65.8)	41,500 (71)	36,100 (74.5)	30,250 (77)	23,550 (79.3)	—	—	—	—	—
25	37,200 (28.9)	40,150 (49.9)	40,900 (60.3)	38,150 (66.7)	32,950 (71)	27,400 (74.1)	21,150 (76.7)	18,600 (78.9)	—	—	—	—
30	—	31,200 (40.5)	31,950 (54.3)	32,400 (62.1)	30,250 (67.4)	24,700 (71.1)	19,100 (74.2)	16,950 (76.7)	14,500 (78.4)	11,300 (79.9)	—	—
35	—	24,300 (28.5)	24,900 (47.6)	26,200 (57.2)	26,000 (63.6)	22,350 (68)	17,250 (71.5)	15,450 (74.3)	13,900 (76.4)	11,300 (78)	10,050 (78.8)	—
40	—	—	19,250 (39.6)	20,500 (52)	20,200 (59.5)	19,900 (64.8)	15,700 (68.8)	14,150 (72)	12,800 (74.3)	11,300 (76.1)	10,050 (77)	—
45	—	—	15,250 (30)	16,300 (46.1)	16,100 (55.3)	16,400 (61.4)	14,350 (66.1)	12,950 (69.6)	11,750 (72.1)	10,700 (74.2)	10,050 (75.2)	—
50	—	—	12,350 (15.5)	13,200 (39.2)	13,100 (50.7)	13,600 (57.8)	12,950 (63)	11,800 (67.1)	10,850 (70)	9930 (72.3)	9470 (73.4)	—
55	—	—	—	10,800 (31.1)	10,750 (45.2)	11,250 (54)	10,750 (59.8)	10,150 (64.4)	10,000 (67.8)	9200 (70.3)	8780 (71.5)	—
60	—	—	—	8900 (20.4)	8820 (39.1)	9340 (49.9)	8950 (56.5)	8730 (61.5)	8810 (65.4)	8540 (68.3)	8160 (69.6)	—
65	—	—	—	—	7370 (32)	7690 (44.8)	7450 (53)	7500 (58.5)	7510 (62.8)	7510 (66.2)	7300 (67.7)	—
70	—	—	—	—	6170 (23.3)	6280 (39.2)	6190 (48.9)	6420 (55.4)	6400 (60.2)	6370 (63.9)	6400 (65.6)	—
75	—	—	—	—	5130 (8.2)	5050 (32.9)	5110 (44.2)	5470 (52.1)	5430 (57.4)	5400 (61.5)	5540 (63.4)	—
80	—	—	—	—	—	3960 (25.4)	4170 (39.1)	4630 (48.2)	4600 (54.6)	4560 (59.1)	4720 (61.2)	—
85	—	—	—	—	—	3010 (15)	3350 (33.4)	3880 (43.8)	3860 (51.6)	3840 (56.6)	3940 (58.9)	—
90	—	—	—	—	—	—	2630 (26.9)	3200 (39.1)	3200 (47.7)	3200 (54)	3190 (56.5)	—
95	—	—	—	—	—	—	1980 (18.6)	2590 (34)	2610 (43.6)	2640 (51)	2480 (54)	—
100	—	—	—	—	—	—	—	2030 (28.1)	2090 (39.2)	2140 (47.4)	1790 (51.1)	—
105	—	—	—	—	—	—	—	1520 (21.1)	1610 (34.5)	1690 (43.5)	1140 (47.5)	—
110	—	—	—	—	—	—	—	1060 (10.5)	1180 (29.2)	1280 (39.4)	510 (43.8)	—
115	—	—	—	—	—	—	—	—	780 (23)	910 (35)	—	—
120	—	—	—	—	—	—	—	—	—	580 (30.1)	—	—

NOTE: () Boom angles are in degrees.

Boom Angle	Main Boom Length in Feet											
	36.8	48	60	72	84	96	108	120	132	144	151	
0°	14,400 (28.3)	10,000 (39.5)	6570 (51.5)	4360 (63.5)	2820 (75.5)	1690 (87.5)	—	—	—	—	—	—

NOTE: () Reference radii in feet.

Load charts

NBT55L/NTC55L and NBT50L/NTC50L

 11 m – 46 m (36 ft – 151 ft)
  1361 kg (3000 lb)
  100%
  Over rear

 Pounds

Radius in Feet	Main Boom Length in Feet										
	36.8	48	60	72	84	96	108	120	132	144	151
6	110,000 (71.5)	41,500 (76.7)	—	—	—	—	—	—	—	—	—
8	106,500 (68)	41,500 (74.2)	41,500 (78.2)	—	—	—	—	—	—	—	—
10	96,050 (64.4)	41,500 (71.6)	41,500 (76.2)	41,500 (79.4)	—	—	—	—	—	—	—
12	87,100 (60.7)	41,500 (69)	41,500 (74.2)	41,500 (77.8)	—	—	—	—	—	—	—
15	75,200 (54.9)	41,500 (64.9)	41,500 (71.1)	41,500 (75.3)	39,700 (78)	33,200 (79.9)	—	—	—	—	—
20	55,700 (43.7)	41,500 (57.8)	41,500 (65.8)	41,500 (71)	36,100 (74.5)	30,250 (77)	23,550 (79.3)	—	—	—	—
25	37,200 (28.9)	41,500 (49.9)	41,500 (60.3)	38,150 (66.7)	32,950 (71)	27,400 (74.1)	21,150 (76.7)	18,600 (78.9)	—	—	—
30	—	34,050 (40.5)	34,750 (54.3)	34,950 (62.1)	30,250 (67.4)	24,700 (71.1)	19,100 (74.2)	16,950 (76.7)	14,500 (78.4)	11,300 (79.9)	—
35	—	27,200 (28.5)	28,050 (47.6)	28,350 (57.2)	27,950 (63.6)	22,350 (68)	17,250 (71.5)	15,450 (74.3)	13,900 (76.4)	11,300 (78)	10,050 (78.8)
40	—	—	22,150 (39.6)	22,400 (52)	22,550 (59.5)	20,300 (64.8)	15,700 (68.8)	14,150 (72)	12,800 (74.3)	11,300 (76.1)	10,050 (77)
45	—	—	17,950 (30)	18,250 (46.1)	18,400 (55.3)	18,550 (61.4)	14,350 (66.1)	12,950 (69.6)	11,750 (72.1)	10,700 (74.2)	10,050 (75.2)
50	—	—	13,050 (15.5)	15,100 (39.2)	15,250 (50.7)	15,350 (57.8)	13,200 (63)	11,900 (67.1)	10,850 (70)	9930 (72.3)	9470 (73.4)
55	—	—	—	12,650 (31.1)	12,750 (45.2)	12,900 (54)	12,150 (59.8)	11,000 (64.4)	10,000 (67.8)	9200 (70.3)	8780 (71.5)
60	—	—	—	10,700 (20.4)	10,850 (39.1)	11,000 (49.9)	11,100 (56.5)	10,150 (61.5)	9300 (65.4)	8540 (68.3)	8160 (69.6)
65	—	—	—	—	9290 (32)	9410 (44.8)	9480 (53)	9460 (58.5)	8640 (62.8)	7940 (66.2)	7590 (67.7)
70	—	—	—	—	7960 (23.3)	8070 (39.2)	8140 (48.9)	8210 (55.4)	8030 (60.2)	7380 (63.9)	7070 (65.6)
75	—	—	—	—	5380 (8.2)	6950 (32.9)	7010 (44.2)	7070 (52.1)	7120 (57.4)	6840 (61.5)	6550 (63.4)
80	—	—	—	—	—	5980 (25.4)	6040 (39.1)	6100 (48.2)	6140 (54.6)	6160 (59.1)	5980 (61.2)
85	—	—	—	—	—	5130 (15)	5210 (33.4)	5260 (43.8)	5300 (51.6)	5320 (56.6)	5270 (58.9)
90	—	—	—	—	—	—	4480 (26.9)	4530 (39.1)	4570 (47.7)	4580 (54)	4540 (56.5)
95	—	—	—	—	—	—	3830 (18.6)	3880 (34)	3920 (43.6)	3930 (51)	3890 (54)
100	—	—	—	—	—	—	—	3310 (28.1)	3350 (39.2)	3360 (47.4)	3320 (51.1)
105	—	—	—	—	—	—	—	2800 (21.1)	2830 (34.5)	2850 (43.5)	2800 (47.5)
110	—	—	—	—	—	—	—	2340 (10.5)	2380 (29.2)	2390 (39.4)	2340 (43.8)
115	—	—	—	—	—	—	—	—	1960 (23)	1970 (35)	1930 (39.8)
120	—	—	—	—	—	—	—	—	1580 (14.8)	1600 (30.1)	1550 (35.6)
125	—	—	—	—	—	—	—	—	—	1260 (24.6)	1210 (31)
130	—	—	—	—	—	—	—	—	—	940 (17.7)	900 (25.7)
135	—	—	—	—	—	—	—	—	—	—	610 (19.5)

NOTE: () Boom angles are in degrees.

Boom Angle	Main Boom Length in Feet										
	36.8	48	60	72	84	96	108	120	132	144	151
0°	14,400 (28.3)	10,000 (39.5)	6570 (51.5)	4360 (63.5)	2820 (75.5)	1690 (87.5)	—	—	—	—	—

NOTE: () Reference radii in feet.

Load charts

NBT55L/NTC55L



11 m – 46 m (36 ft – 151 ft)

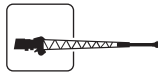

11 m (36 ft)



2722 kg (6000 lb)



100%



360°



Pounds

Radius in Feet	Main Boom Length in Feet											
	0° OFFSET ANGLE				15° OFFSET ANGLE				30° OFFSET ANGLE			
	120	132	144	151	120	132	144	151	120	132	144	151
30	7720 (78.4)	—	—	—	—	—	—	—	—	—	—	—
35	7720 (76.9)	6370 (78.5)	—	4300 (80)	—	—	—	—	—	—	—	—
40	7720 (75.4)	6370 (77)	5200 (78.5)	4300 (78.8)	7000 (79)	—	—	—	—	—	—	—
45	7720 (73.9)	6370 (75.6)	5200 (77.2)	4300 (77.6)	6730 (77.5)	6620 (78.4)	—	—	—	—	—	—
50	7670 (72.3)	6370 (74.1)	5200 (75.8)	4300 (76.3)	6540 (76.1)	6400 (77.1)	—	—	5660 (78.8)	5550 (79.8)	—	—
55	7260 (70.7)	6370 (72.7)	5200 (74.5)	4300 (75.1)	6360 (74.6)	6150 (75.8)	5590 (76.8)	4940 (77.3)	5530 (77.3)	5440 (78.4)	5290 (79.4)	—
60	6880 (69.1)	6370 (71.2)	5200 (73.1)	4300 (73.8)	6100 (73.1)	5880 (74.4)	5590 (75.6)	4940 (76.1)	5420 (75.7)	5350 (77)	5190 (78.1)	5050 (78.6)
65	6520 (67.4)	6260 (69.7)	5200 (71.7)	4300 (72.6)	5810 (71.6)	5620 (73.1)	5370 (74.3)	4940 (74.9)	5320 (74.1)	5190 (75.6)	5000 (76.8)	4870 (77.4)
70	6180 (65.7)	5960 (68.1)	5200 (70.2)	4300 (71.3)	5550 (70)	5380 (71.7)	5160 (73)	4940 (73.7)	5140 (72.5)	4990 (74.1)	4810 (75.5)	4700 (76.2)
75	5870 (64)	5690 (66.5)	5200 (68.8)	4300 (70)	5300 (68.4)	5150 (70.2)	4960 (71.7)	4840 (72.5)	4940 (70.8)	4800 (72.6)	4640 (74.2)	4540 (74.9)
80	5580 (62.2)	5400 (64.9)	4990 (67.3)	4300 (68.6)	5070 (66.7)	4930 (68.7)	4760 (70.4)	4660 (71.2)	4760 (68.8)	4630 (71.1)	4470 (72.8)	4380 (73.6)
85	5310 (59.9)	5060 (63.2)	4680 (65.7)	4300 (67.2)	4860 (64.4)	4730 (67.2)	4580 (69)	4480 (69.9)	4580 (66.1)	4460 (69.5)	4320 (71.4)	4230 (72.3)
90	4710 (57.4)	4590 (61.3)	4380 (64.2)	4200 (65.8)	4660 (61.9)	4550 (65.3)	4400 (67.6)	4250 (68.6)	4420 (63.4)	4310 (67.2)	4170 (70)	4090 (71)
95	4080 (54.8)	3960 (59.1)	3840 (62.6)	3740 (64.1)	4480 (59.3)	4370 (62.9)	4150 (66.1)	3980 (67.2)	4270 (60.6)	4160 (64.6)	4030 (68.1)	3960 (69.6)
100	3520 (52.2)	3400 (56.8)	3290 (60.6)	3190 (62.2)	3900 (56.7)	3810 (60.4)	3720 (63.8)	3640 (65.5)	4130 (57.7)	4020 (62)	3900 (65.7)	3820 (67.5)
105	3030 (49.4)	2910 (54.4)	2790 (58.5)	2690 (60.2)	3370 (53.9)	3280 (57.9)	3190 (61.5)	3100 (63.2)	3630 (54.6)	3580 (59.3)	3520 (63.3)	3450 (65.2)
110	2580 (46.5)	2460 (51.9)	2340 (56.3)	2250 (58.2)	2890 (51)	2800 (55.3)	2710 (59.1)	2630 (60.9)	3120 (51.5)	3070 (56.5)	3010 (60.8)	2940 (62.8)
115	2180 (43.4)	2060 (49.4)	1940 (54.1)	1850 (56.1)	2450 (47.9)	2370 (52.6)	2280 (56.6)	2200 (58.6)	2650 (48.1)	2600 (53.6)	2540 (58.2)	2480 (60.4)
120	1820 (40.1)	1700 (46.7)	1580 (51.8)	1480 (53.9)	2060 (44.6)	1970 (49.8)	1890 (54.1)	1800 (56.1)	2230 (44.5)	2180 (50.6)	2120 (55.5)	2060 (57.8)
125	1500 (36.6)	1370 (43.9)	1250 (49.5)	1150 (51.2)	1700 (41.1)	1620 (46.8)	1530 (51.4)	1450 (53.6)	1830 (40.6)	1800 (47.4)	1740 (52.8)	1680 (55.2)
130	1200 (32.7)	1070 (40.9)	950 (47)	850 (48.3)	1370 (37.2)	1290 (43.7)	1200 (48.7)	1120 (51)	1470 (36)	1440 (44)	1390 (49.9)	1330 (52.5)
135	930 (27.8)	800 (37.6)	670 (44.4)	580 (45.3)	1070 (31.6)	990 (40.3)	900 (45.8)	820 (48.3)	—	1110 (40.4)	1070 (46.8)	1000 (49.7)
140	690 (20.9)	550 (34.1)	—	—	790 (24.1)	710 (36.6)	630 (42.8)	550 (45.5)	—	810 (36.3)	770 (43.6)	700 (46.8)

NOTE: () Boom angles are in degrees.

Load charts

NBT55L/NTC55L



11 m – 46 m (36 ft – 151 ft)

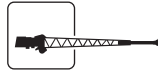

11 m (36 ft)



2722 kg (6000 lb)



100%



Over rear



Pounds

Radius in Feet	Main Boom Length in Feet											
	0° OFFSET ANGLE				15° OFFSET ANGLE				30° OFFSET ANGLE			
	120	132	144	151	120	132	144	151	120	132	144	151
30	7720 (78.4)	—	—	—	—	—	—	—	—	—	—	—
35	7720 (76.9)	6370 (78.5)	—	4300 (80)	—	—	—	—	—	—	—	—
40	7720 (75.4)	6370 (77)	5200 (78.5)	4300 (78.8)	7000 (79)	—	—	—	—	—	—	—
45	7720 (73.9)	6370 (75.6)	5200 (77.2)	4300 (77.6)	6730 (77.5)	6620 (78.4)	—	—	—	—	—	—
50	7670 (72.3)	6370 (74.1)	5200 (75.8)	4300 (76.3)	6540 (76.1)	6400 (77.1)	—	—	5660 (78.8)	5550 (79.8)	—	—
55	7260 (70.7)	6370 (72.7)	5200 (74.5)	4300 (75.1)	6360 (74.6)	6150 (75.8)	5590 (76.8)	4940 (77.3)	5530 (77.3)	5440 (78.4)	5290 (79.4)	—
60	6880 (69.1)	6370 (71.2)	5200 (73.1)	4300 (73.8)	6100 (73.1)	5880 (74.4)	5590 (75.6)	4940 (76.1)	5420 (75.7)	5350 (77)	5190 (78.1)	5050 (78.6)
65	6520 (67.4)	6260 (69.7)	5200 (71.7)	4300 (72.6)	5810 (71.6)	5620 (73.1)	5370 (74.3)	4940 (74.9)	5320 (74.1)	5190 (75.6)	5000 (76.8)	4870 (77.4)
70	6180 (65.7)	5960 (68.1)	5200 (70.2)	4300 (71.3)	5550 (70)	5380 (71.7)	5160 (73)	4940 (73.7)	5140 (72.5)	4990 (74.1)	4810 (75.5)	4700 (76.2)
75	5870 (64)	5690 (66.5)	5200 (68.8)	4300 (70)	5300 (68.4)	5150 (70.2)	4960 (71.7)	4840 (72.5)	4940 (70.8)	4800 (72.6)	4640 (74.2)	4540 (74.9)
80	5580 (62.2)	5400 (64.9)	4990 (67.3)	4300 (68.6)	5070 (66.7)	4930 (68.7)	4760 (70.4)	4660 (71.2)	4760 (68.8)	4630 (71.1)	4470 (72.8)	4380 (73.6)
85	5310 (59.9)	5060 (63.2)	4680 (65.7)	4300 (67.2)	4860 (64.4)	4730 (67.2)	4580 (69)	4480 (69.9)	4580 (66.1)	4460 (69.5)	4320 (71.4)	4230 (72.3)
90	5070 (57.4)	4750 (61.3)	4380 (64.2)	4200 (65.8)	4660 (61.9)	4550 (65.3)	4400 (67.6)	4250 (68.6)	4420 (63.4)	4310 (67.2)	4170 (70)	4090 (71)
95	4830 (54.8)	4450 (59.1)	4100 (62.6)	3930 (64.1)	4480 (59.3)	4370 (62.9)	4150 (66.1)	3980 (67.2)	4270 (60.6)	4160 (64.6)	4030 (68.1)	3960 (69.6)
100	4540 (52.2)	4170 (56.8)	3840 (60.6)	3670 (62.2)	4310 (56.7)	4200 (60.4)	3890 (63.8)	3730 (65.5)	4130 (57.7)	4020 (62)	3900 (63.3)	3820 (67.5)
105	4140 (49.4)	3920 (54.4)	3600 (58.5)	3380 (60.2)	4150 (53.9)	3950 (57.9)	3650 (61.5)	3500 (63.2)	4010 (54.6)	3900 (59.3)	3730 (63.3)	3580 (65.2)
110	3650 (46.5)	3530 (51.9)	3370 (56.3)	3020 (58.2)	3950 (51)	3710 (55.3)	3420 (59.1)	3240 (60.9)	3890 (51.5)	3780 (56.5)	3500 (60.8)	3360 (62.8)
115	3210 (43.4)	3080 (49.4)	2970 (54.1)	2690 (56.1)	3470 (47.9)	3390 (52.6)	3200 (56.6)	2900 (58.6)	3670 (48.1)	3550 (53.6)	3280 (58.2)	3060 (60.4)
120	2800 (40.1)	2680 (46.7)	2560 (51.8)	2390 (53.9)	3040 (44.6)	2950 (49.8)	2870 (54.1)	2580 (56.1)	3200 (44.5)	3160 (50.6)	3070 (55.5)	2730 (57.8)
125	2440 (36.6)	2310 (43.9)	2200 (49.5)	2100 (51.2)	2640 (41.1)	2560 (46.8)	2470 (51.4)	2290 (53.6)	2770 (40.6)	2730 (47.4)	2680 (52.8)	2430 (55.2)
130	2110 (32.7)	1980 (40.9)	1860 (47)	1760 (48.3)	2280 (37.2)	2200 (43.7)	2110 (48.7)	2020 (51)	2380 (36)	2340 (44)	2290 (49.9)	2140 (52.5)
135	1810 (27.8)	1670 (37.6)	1550 (44.4)	1460 (45.3)	1940 (31.6)	1860 (40.3)	1780 (45.8)	1700 (48.3)	—	1980 (40.4)	1940 (46.8)	1880 (49.7)
140	1530 (20.9)	1390 (34.1)	1270 (41.6)	1170 (42.2)	1630 (24.1)	1550 (36.6)	1470 (42.8)	1390 (45.5)	—	1650 (36.3)	1610 (43.6)	1550 (46.8)
145	1290 (12)	1140 (29.8)	1010 (38.6)	910 (39)	—	1270 (31.9)	1190 (39.5)	1110 (42.5)	—	—	1300 (40.2)	1240 (43.7)
150	—	900 (23.4)	770 (35.4)	670 (35.6)	—	1010 (25.4)	920 (36)	850 (39.4)	—	—	1010 (36.4)	960 (40.4)
155	—	690 (15.7)	550 (31.8)	—	—	760 (17.5)	680 (31.9)	600 (36)	—	—	—	690 (36.8)

NOTE: () Boom angles are in degrees.

Load charts

NBT55L/NTC55L and NBT50L/NTC50L



11 m – 46 m (36 ft – 151 ft)

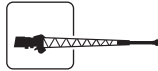

11 m (36 ft)



1361 kg (3000 lb)



100%



360°



Pounds

Radius in Feet	Main Boom Length in Feet											
	0° OFFSET ANGLE				15° OFFSET ANGLE				30° OFFSET ANGLE			
	120	132	144	151	120	132	144	151	120	132	144	151
30	7640 (78.4)	—	—	—	—	—	—	—	—	—	—	—
35	7640 (76.9)	6310 (78.5)	5060 (79.9)	4300 (80)	—	—	—	—	—	—	—	—
40	7640 (75.4)	6310 (77)	5060 (78.5)	4300 (78.8)	7000 (79)	—	—	—	—	—	—	—
45	7640 (73.9)	6310 (75.6)	5060 (77.2)	4300 (77.6)	6730 (77.5)	—	—	—	—	—	—	—
50	7640 (72.3)	6310 (74.1)	5060 (75.8)	4300 (76.3)	6540 (76.1)	6400 (77.1)	—	—	5660 (78.8)	—	—	—
55	7260 (70.7)	6310 (72.7)	5060 (74.5)	4300 (75.1)	6360 (74.6)	6150 (75.8)	5410 (76.8)	4650	5530 (77.3)	5440 (78.4)	—	—
60	6880 (69.1)	6310 (71.2)	5060 (73.1)	4300 (73.8)	6100 (73.1)	5880 (74.4)	5410 (75.6)	4650 (76.1)	5420 (75.7)	5350 (77)	5190 (78.1)	—
65	6520 (67.4)	6260 (69.7)	5060 (71.7)	4300 (72.6)	5810 (71.6)	5620 (73.1)	5370 (74.3)	4650 (74.9)	5320 (74.1)	5190 (75.6)	5000 (76.8)	4870 (77.4)
70	6180 (65.7)	5960 (68.1)	5060 (70.2)	4300 (71.3)	5550 (70)	5380 (71.7)	5160 (73)	4650 (73.7)	5140 (72.5)	4990 (74.1)	4810 (75.5)	4700 (76.2)
75	5870 (64)	5690 (66.5)	5060 (68.8)	4300 (70)	5300 (68.4)	5150 (70.2)	4960 (71.7)	4650 (72.5)	4940 (70.8)	4800 (72.6)	4640 (74.2)	4540 (74.9)
80	5380 (62.2)	5260 (64.9)	4990 (67.3)	4300 (68.6)	5070 (66.7)	4930 (68.7)	4760 (70.4)	4650 (71.2)	4760 (68.8)	4630 (71.1)	4470 (72.8)	4380 (73.6)
85	4620 (59.9)	4490 (63.2)	4380 (65.7)	4270 (67.2)	4860 (64.4)	4730 (67.2)	4580 (69)	4480 (69.9)	4580 (66.1)	4460 (69.5)	4320 (71.4)	4230 (72.3)
90	3950 (57.4)	3830 (61.3)	3710 (64.2)	3610 (65.8)	4410 (61.9)	4320 (65.3)	4230 (67.6)	4140 (68.6)	4420 (63.4)	4310 (67.2)	4170 (70)	4090 (71)
95	3360 (54.8)	3240 (59.1)	3130 (62.6)	3030 (64.1)	3780 (59.3)	3690 (62.9)	3600 (66.1)	3520 (67.2)	4130 (60.6)	4070 (64.6)	4000 (68.1)	3930 (69.6)
100	2850 (52.2)	2730 (56.8)	2610 (60.6)	2510 (62.2)	3220 (56.7)	3140 (60.4)	3040 (63.8)	2960 (65.5)	3530 (57.7)	3470 (62)	3410 (65.7)	3340 (67.5)
105	2390 (49.4)	2270 (54.4)	2150 (58.5)	2050 (60.2)	2730 (53.9)	2640 (57.9)	2550 (61.5)	2460 (63.2)	2990 (54.6)	2940 (59.3)	2880 (63.3)	2810 (65.2)
110	1980 (46.5)	1850 (51.9)	1740 (56.3)	1640 (58.2)	2280 (51)	2190 (55.3)	2100 (59.1)	2020 (60.9)	2510 (51.5)	2460 (56.5)	2400 (60.8)	2330 (62.8)
115	1610 (43.4)	1480 (49.4)	1370 (54.1)	1270 (56.1)	1880 (47.9)	1790 (52.6)	1700 (56.6)	1620 (58.6)	2070 (48.1)	2030 (53.6)	1970 (58.2)	1900 (60.4)
120	1270 (40.1)	1150 (46.7)	1030 (51.8)	930 (53.9)	1510 (44.6)	1420 (49.8)	1340 (54.1)	1250 (56.1)	1680 (44.5)	1630 (50.6)	1570 (55.5)	1510 (57.8)
125	970 (36.6)	840 (43.9)	720 (49.5)	630 (51.2)	1170 (41.1)	1090 (46.8)	1000 (51.4)	920 (53.6)	1310 (40.6)	1270 (47.4)	1220 (52.8)	1150 (55.2)
130	700 (32.7)	570 (40.9)	—	—	870 (37.2)	790 (43.7)	700 (48.7)	620 (51)	970 (36)	940 (44)	890 (49.9)	820 (52.5)
135	—	—	—	—	590 (31.6)	500 (40.3)	—	—	—	630 (40.4)	580 (46.8)	520 (49.7)

NOTE: () Boom angles are in degrees.

Load charts

NBT55L/NTC55L and NBT50L/NTC50L



11 m – 46 m (36 ft – 151 ft)

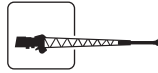

11 m (36 ft)



1361 kg (3000 lb)



100%



Over rear



Pounds

Radius in Feet	Main Boom Length in Feet											
	0° OFFSET ANGLE				15° OFFSET ANGLE				30° OFFSET ANGLE			
	120	132	144	151	120	132	144	151	120	132	144	151
30	7640 (78.4)	—	—	—	—	—	—	—	—	—	—	—
35	7640 (76.9)	6310 (78.5)	5060 (79.9)	4300 (80)	—	—	—	—	—	—	—	—
40	7640 (75.4)	6310 (77)	5060 (78.5)	4300 (78.8)	7000 (79)	—	—	—	—	—	—	—
45	7640 (73.9)	6310 (75.6)	5060 (77.2)	4300 (77.6)	6730 (77.5)	—	—	—	—	—	—	—
50	7640 (72.3)	6310 (74.1)	5060 (75.8)	4300 (76.3)	6540 (76.1)	6400 (77.1)	—	—	5660 (78.8)	—	—	—
55	7260 (70.7)	6310 (72.7)	5060 (74.5)	4300 (75.1)	6360 (74.6)	6150 (75.8)	5410 (76.8)	4650 (77.3)	5530 (77.3)	5440 (78.4)	—	—
60	6880 (69.1)	6310 (71.2)	5060 (73.1)	4300 (73.8)	6100 (73.1)	5880 (74.4)	5410 (75.6)	4650 (76.1)	5420 (75.7)	5350 (77)	5190 (78.1)	—
65	6520 (67.4)	6260 (69.7)	5060 (71.7)	4300 (72.6)	5810 (71.6)	5620 (73.1)	5370 (74.3)	4650 (74.9)	5320 (74.1)	5190 (75.6)	5000 (76.8)	4870 (77.4)
70	6180 (65.7)	5960 (68.1)	5060 (70.2)	4300 (71.3)	5550 (70)	5380 (71.7)	5160 (73)	4650 (73.7)	5140 (72.5)	4990 (74.1)	4810 (75.5)	4700 (76.2)
75	5870 (64)	5690 (66.5)	5060 (68.8)	4300 (70)	5300 (68.4)	5150 (70.2)	4960 (71.7)	4650 (72.5)	4940 (70.8)	4800 (72.6)	4640 (74.2)	4540 (74.9)
80	5580 (62.2)	5400 (64.9)	4990 (67.3)	4300 (68.6)	5070 (66.7)	4930 (68.7)	4760 (70.4)	4650 (71.2)	4760 (68.8)	4630 (71.1)	4470 (72.8)	4380 (73.6)
85	5310 (59.9)	5060 (63.2)	4680 (65.7)	4300 (67.2)	4860 (64.4)	4730 (67.2)	4580 (69)	4480 (69.9)	4580 (66.1)	4460 (69.5)	4320 (71.4)	4230 (72.3)
90	5070 (57.4)	4750 (61.3)	4380 (64.2)	4200 (65.8)	4660 (61.9)	4550 (65.3)	4400 (67.6)	4250 (68.6)	4420 (63.4)	4310 (67.2)	4170 (70)	4090 (71)
95	4650 (54.8)	4450 (59.1)	4100 (62.6)	3930 (64.1)	4480 (59.3)	4370 (62.9)	4150 (66.1)	3980 (67.2)	4270 (60.6)	4160 (64.6)	4030 (68.1)	3960 (69.6)
100	4070 (52.2)	3960 (56.8)	3840 (60.6)	3670 (62.2)	4310 (56.7)	4200 (60.4)	3890 (63.8)	3730 (65.5)	4130 (57.7)	4020 (62)	3900 (65.7)	3820 (67.5)
105	3560 (49.4)	3440 (54.4)	3320 (58.5)	3230 (60.2)	3890 (53.9)	3800 (57.9)	3650 (61.5)	3500 (63.2)	4010 (54.6)	3900 (59.3)	3730 (63.3)	3580 (65.2)
110	3090 (46.5)	2970 (51.9)	2860 (56.3)	2760 (58.2)	3390 (51)	3310 (55.3)	3220 (59.1)	3140 (60.9)	3620 (51.5)	3570 (56.5)	3500 (60.8)	3360 (62.8)
115	2680 (43.4)	2550 (49.4)	2440 (54.1)	2340 (56.1)	2940 (47.9)	2860 (52.6)	2770 (56.6)	2690 (58.6)	3140 (48.1)	3090 (53.6)	3030 (58.2)	2970 (60.4)
120	2300 (40.1)	2180 (46.7)	2060 (51.8)	1960 (53.9)	2530 (44.6)	2450 (49.8)	2360 (54.1)	2280 (56.1)	2700 (44.5)	2650 (50.6)	2600 (55.5)	2530 (57.8)
125	1950 (36.6)	1830 (43.9)	1710 (49.5)	1620 (51.2)	2160 (41.1)	2070 (46.8)	1990 (51.4)	1910 (53.6)	2290 (40.6)	2250 (47.4)	2200 (52.8)	2130 (55.2)
130	1640 (32.7)	1520 (40.9)	1400 (47)	1300 (48.3)	1810 (37.2)	1730 (43.7)	1650 (48.7)	1570 (51)	1910 (36)	1880 (44)	1830 (49.9)	1770 (52.5)
135	1360 (27.8)	1230 (37.6)	1110 (44.4)	1010 (45.3)	1500 (31.6)	1420 (40.3)	1330 (45.8)	1250 (48.3)	—	1540 (40.4)	1490 (46.8)	1430 (49.7)
140	1110 (20.9)	970 (34.1)	840 (41.6)	750 (42.2)	1210 (24.1)	1130 (36.6)	1040 (42.8)	960 (45.5)	—	1220 (36.3)	1180 (43.6)	1120 (46.8)
145	880 (12)	730 (29.8)	600 (38.6)	500 (39)	—	860 (31.9)	780 (39.5)	700 (42.5)	—	—	890 (40.2)	830 (43.7)
150	—	510 (23.4)	—	—	—	610 (25.4)	530 (36)	—	—	—	620 (36.4)	560 (40.4)

NOTE: () Boom angles are in degrees.

Working range diagram



46,0 m (151 ft)



8 m - 14 m (26 ft - 45 ft)



100%



360°

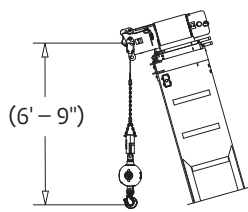
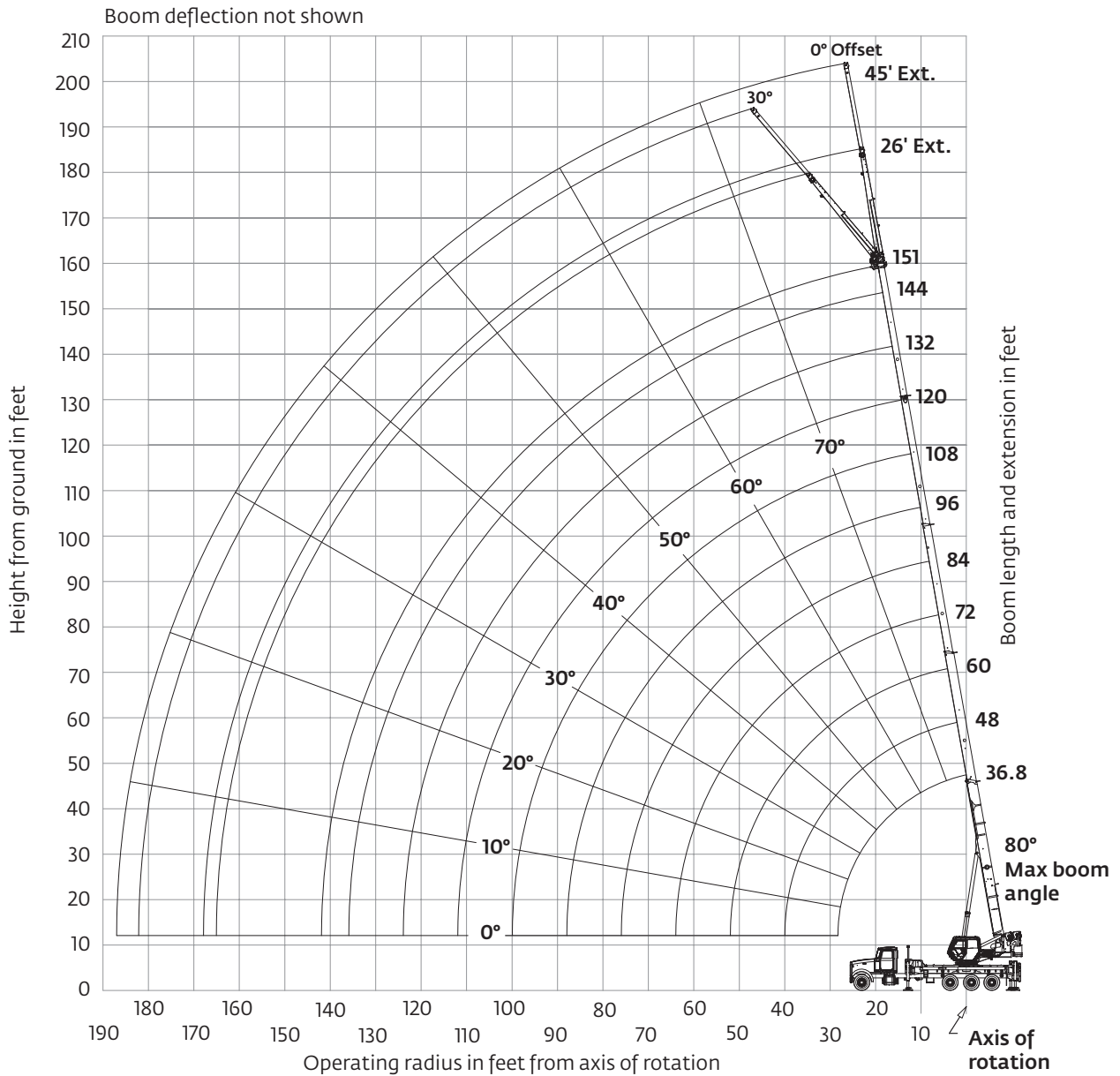

(6' - 9'')

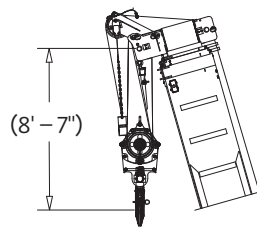

(8' - 7'')

Dimensions are for largest furnished hook block and headache ball with anti-two-block activated.

**This drawing shows the physical reach of the machine. Always refer to load chart to see which portions of this diagram are valid for the specific machine configuration and where the loads are structurally or stability limited.*

Load charts

NBT55L/NTC55L



11 m – 46 m
(36 ft – 151 ft)



8 m – 14 m
(26 ft – 45 ft)



2722 kg
(6000 lb)



100%



360°



Pounds

Radius in Feet	Main Boom Length in Feet			
	26 FT EXTENSION AT 0° OFFSET ANGLE	26 FT EXTENSION AT 30° OFFSET ANGLE	45 FT EXTENSION AT 0° OFFSET ANGLE	45 FT EXTENSION AT 30° OFFSET ANGLE
	151	151	151	151
40	5200 (79.6)	—	3700 (79.1)	—
45	5200 (78)	—	3700 (78)	—
50	5200 (76.4)	—	3700 (76.8)	—
55	5200 (74.8)	4800 (78.3)	3700 (75.7)	—
60	5200 (73.2)	4710 (76.6)	3700 (74.5)	—
65	4900 (71.6)	4530 (74.7)	3700 (73.3)	2500 (78.8)
70	4600 (69.9)	4320 (72.9)	3700 (72.1)	2500 (77.5)
75	4350 (68.2)	4130 (71)	3700 (70.9)	2500 (76.1)
80	4110 (66.5)	4000 (69.1)	3610 (69.7)	2500 (74.7)
85	3900 (64.7)	3850 (67.5)	3430 (68.3)	2500 (73.2)
90	3410 (62.9)	3710 (65.9)	3190 (66.8)	2500 (71.7)
95	2790 (61)	3440 (64.3)	2980 (65.3)	2480 (70.2)
100	2250 (58.9)	2830 (62.4)	2740 (63.7)	2440 (68.7)
105	1760 (56.7)	2280 (59.9)	2480 (62)	2400 (66.9)
110	1320 (54.4)	1790 (57.5)	2030 (60.3)	2360 (65)
115	930 (52)	1350 (55.1)	1630 (58.4)	2320 (63)
120	570 (49.6)	950 (52.6)	1260 (56.5)	2000 (61)
125	—	580 (49.9)	930 (54.5)	1610 (58.9)
130	—	—	630 (52.5)	1240 (56.8)
135	—	—	—	910 (54.5)
140	—	—	—	600 (52.2)

NOTE: () Boom angles are in degrees.

Load charts

NBT55L/NTC55L



11 m – 46 m
(36 ft – 151 ft)



8 m – 14 m
(26 ft – 45 ft)



2722 kg
(6000 lb)



100%



Over rear



Pounds

Radius in Feet	Main Boom Length in Feet			
	26 FT EXTENSION AT 0° OFFSET ANGLE	26 FT EXTENSION AT 30° OFFSET ANGLE	45 FT EXTENSION AT 0° OFFSET ANGLE	45 FT EXTENSION AT 30° OFFSET ANGLE
	151	151	151	151
40	5200 (79.6)	—	3700 (79.1)	—
45	5200 (78)	—	3700 (78)	—
50	5200 (76.4)	—	3700 (76.8)	—
55	5200 (74.8)	4800 (78.3)	3700 (75.7)	—
60	5200 (73.2)	4710 (76.6)	3700 (74.5)	—
65	4900 (71.6)	4530 (74.7)	3700 (73.3)	2500 (78.8)
70	4600 (69.9)	4320 (72.9)	3700 (72.1)	2500 (77.5)
75	4350 (68.2)	4130 (71)	3700 (70.9)	2500 (76.1)
80	4110 (66.5)	4000 (69.1)	3610 (69.7)	2500 (74.7)
85	3900 (64.7)	3850 (67.5)	3430 (68.3)	2500 (73.2)
90	3750 (62.9)	3710 (65.9)	3190 (66.8)	2500 (71.7)
95	3450 (61)	3530 (64.3)	2980 (65.3)	2480 (70.2)
100	3160 (58.9)	3280 (62.4)	2740 (63.7)	2440 (68.7)
105	2810 (56.7)	2940 (59.9)	2560 (62)	2400 (66.9)
110	2400 (54.4)	2670 (57.5)	2390 (60.3)	2360 (65)
115	1960 (52)	2370 (55.1)	2230 (58.4)	2320 (63)
120	1560 (49.6)	1930 (52.6)	2020 (56.5)	2280 (61)
125	1200 (47.2)	1530 (49.9)	1810 (54.5)	2220 (58.9)
130	870 (44.6)	1150 (47.2)	1540 (52.5)	2040 (56.8)
135	—	810 (44.4)	1230 (50.3)	1770 (54.5)
140	—	—	940 (48.1)	1430 (52.2)
145	—	—	—	1120 (49.7)
150	—	—	—	820 (47.1)

NOTE: () Boom angles are in degrees.

Load charts

NBT55L/NTC55L and NBT50L/NTC50L



11 m – 46 m
(36 ft – 151 ft)



8 m – 14 m
(26 ft – 45 ft)



1361 kg
(3000 lb)



100%



360°



Pounds

Radius in Feet	Main Boom Length in Feet			
	26 FT EXTENSION AT 0° OFFSET ANGLE	26 FT EXTENSION AT 30° OFFSET ANGLE	45 FT EXTENSION AT 0° OFFSET ANGLE	45 FT EXTENSION AT 30° OFFSET ANGLE
	151	151	151	151
40	5200 (79.6)	—	3700 (79.1)	—
45	5200 (78)	—	3700 (78)	—
50	5200 (76.4)	—	3700 (76.8)	—
55	5200 (74.8)	4800 (78.3)	3700 (75.7)	—
60	5200 (73.2)	4710 (76.6)	3700 (74.5)	—
65	4900 (71.6)	4530 (74.7)	3700 (73.3)	2500 (78.8)
70	4600 (69.9)	4320 (72.9)	3700 (72.1)	2500 (77.5)
75	4350 (68.2)	4130 (71)	3700 (70.9)	2500 (76.1)
80	4060 (66.5)	4000 (69.1)	3610 (69.7)	2500 (74.7)
85	3310 (64.7)	3850 (67.5)	3430 (68.3)	2500 (73.2)
90	2650 (62.9)	3360 (65.9)	3190 (66.8)	2500 (71.7)
95	2080 (61)	2720 (64.3)	2820 (65.3)	2480 (70.2)
100	1570 (58.9)	2150 (62.4)	2300 (63.7)	2440 (68.7)
105	1120 (56.7)	1640 (59.9)	1840 (62)	2400 (66.9)
110	710 (54.4)	1180 (57.5)	1420 (60.3)	2310 (65)
115	—	770 (55.1)	1050 (58.4)	1860 (63)
120	—	—	710 (56.5)	1450 (61)
125	—	—	—	1080 (58.9)
130	—	—	—	740 (56.8)

NOTE: () Boom angles are in degrees.

Load charts

NBT55L/NTC55L and NBT50L/NTC50L



11 m – 46 m
(36 ft – 151 ft)



8 m – 14 m
(26 ft – 45 ft)



1361 kg
(3000 lb)



100%



360°



Pounds

Radius in Feet	Main Boom Length in Feet			
	26 FT EXTENSION AT 0° OFFSET ANGLE	26 FT EXTENSION AT 30° OFFSET ANGLE	45 FT EXTENSION AT 0° OFFSET ANGLE	45 FT EXTENSION AT 30° OFFSET ANGLE
	151	151	151	151
40	5200 (79.6)	—	3700 (79.1)	—
45	5200 (78)	—	3700 (78)	—
50	5200 (76.4)	—	3700 (76.8)	—
55	5200 (74.8)	4800 (78.3)	3700 (75.7)	—
60	5200 (73.2)	4710 (76.6)	3700 (74.5)	—
65	4900 (71.6)	4530 (74.7)	3700 (73.3)	2500 (78.8)
70	4600 (69.9)	4320 (72.9)	3700 (72.1)	2500 (77.5)
75	4350 (68.2)	4130 (71)	3700 (70.9)	2500 (76.1)
80	4110 (66.5)	4000 (69.1)	3610 (69.7)	2500 (74.7)
85	3900 (64.7)	3850 (67.5)	3430 (68.3)	2500 (73.2)
90	3750 (62.9)	3710 (65.9)	3190 (66.8)	2500 (71.7)
95	3380 (61)	3530 (64.3)	2980 (65.3)	2480 (70.2)
100	2810 (58.9)	3280 (62.4)	2740 (63.7)	2440 (68.7)
105	2300 (56.7)	2810 (59.9)	2560 (62)	2400 (66.9)
110	1840 (54.4)	2310 (57.5)	2390 (60.3)	2360 (65)
115	1430 (52)	1840 (55.1)	2120 (58.4)	2320 (63)
120	1060 (49.6)	1430 (52.6)	1740 (56.5)	2280 (61)
125	720 (47.2)	1040 (49.9)	1390 (54.5)	2060 (58.9)
130	—	690 (47.2)	1070 (52.5)	1680 (56.8)
135	—	—	780 (50.3)	1330 (54.5)
140	—	—	520 (48.1)	1010 (52.2)
145	—	—	—	710 (49.7)

NOTE: () Boom angles are in degrees.

Specifications

Superstructure

Boom

11,1 m – 46 m (36.5 ft – 151 ft) five-section boom with a maximum tip height of 49,1 m (161 ft). Includes proportional extension via multi-stage hydraulic cylinder and cable operation, four-plate, high-strength steel construction, three-sheave, quick-reeve boom nose and Easy-Glide wear pads.

Boom elevation

One (1) double-acting, hydraulic cylinder with integral holding valve and integral pressure transducers provides elevation from -8° to +80°.

Rated Capacity Limiting (RCL) and anti-two-block (ATB) systems

Graphical display capacity limiter and ATB system with audio visual warning and crane function lockout. The graphical display is a 178 mm (7 in) color and polarized screen for real-time display of boom angle, length, radius, tip height, maximum permissible load, load indication, and warning of impending overload or ATB condition. Work area definition system (WADS) provides operator definable non-lockout warning limits for crane operations, and CANbus sensors and hard-wired ATB circuit routed internally to the boom. Outrigger monitoring system (OMS) to sense the configuration of the outriggers and aid the operator in selecting an appropriate setup. Onboard setup and diagnostics for RCL sensors allow for improved service and an event recorder to protect your investment.

Control System

Fully integrated RCL and CANbus crane control system for maximum performance. Real-time diagnostics for truck chassis data such as engine regeneration, fuel level, engine coolant, oil pressure, engine rpm and battery voltage. Onboard setup and diagnostics for all sensors and control modules allows for improved service and little need for a laptop or diagnostic cables. Fault codes to quickly identify service needs, and event recorder to protect your investment.

Operator cab and controls

Cab structure: rigid galvanealed steel structure, well insulated, offering optimum operator visibility and comfort. Equipped with tilting cab feature from horizontal to +20°, tinted safety glass, fixed front window with windshield wiper and washer, sliding skylight window with windshield wiper, sliding left side glass door, sliding right side window for ventilation w/ safety grille, tilting rear window for ventilation, four-way adjustable, cushioned/heated seat and armrests with seat belt, diesel-fired warm-water heater with air ducts at operators feet, left side of cab and front dash — standard, hydraulic-powered

air conditioner — standard, circulation fan, bubble level, adjustable sun visor, dome light, cup holder, fire extinguisher, load chart binder with tear-proof paper load charts and operator manual.

Armrest control functions are arranged per ASME B30.5: Two single axis electric joystick controllers for swing, boom telescope, main hoist, auxiliary hoist (optional), boom lift, warning horn button, swing park brake switch, hoist rotation indicator, tilt cab up/down, main hoist high/low speed switch, and aux hoist high/low speed switch (optional).

Outrigger controls: front console-mounted electronic keypad allowing the operator to activate all horizontal beams and vertical jacks. Pre-selection capabilities to easily activate more than one function for ease of setup.

Rigging remote: Standard wireless rigging remote stored and charged inside the crane cab which allows the operation of the main and (optional) aux hoist to stow and unstow the hookblocks at the front bumper of the truck chassis for transport or operation. If the crane is equipped with an optional single front outrigger (SFO), this remote allows for raising and lowering of this vertical outrigger.

Foot controls: engine throttle (electronic), dynamic swing brake (electronic), boom telescope (electronic, if equipped with aux hoist option).

Front console controls and indicators for RCL display, outriggers, engine ignition key, emergency stop switch, and RCL override keyswitch (momentary). 12VDC power outlet.

Overhead console controls and indicators for heater, A/C and fan speed, windshield wiper and washer, skylight wiper, cab-mounted work lights, crane function power, radio remote power.

Removable counterweight

Hydraulically removable counterweight system consisting of (2) vertical double-acting hydraulic cylinders equipped with holding valves to independently raise and lower the desired counterweight slabs. Controls can be activated at both the left and right side of the turret near the counterweight for ease of activation during counterweight pin reconfiguration. When not in use, one or all of the slabs can be stowed on top of the front outrigger box. One or all of the slabs can also be removed from the crane by using the crane itself after stowing on front outrigger box first.

NBT50L/NTC50L:

Counterweight consists of one slab for two unique load chart configurations:

- (1) slab installed on turret: (1) x 1360 kg (3000 lb)
- (0) slabs installed on turret: no slabs installed
- Single 680 kg (1500 lb) counterweight option is available for maximizing the roading weight configurations in areas where road weights limits are more restricting.

Specifications

NBT55L/NTC55L:

Counterweight consists of (2) slabs for (3) unique load chart configurations:

- (2) slabs installed on turret: (2) x 1360 kg (6000 lb)
- (1) slabs installed on turret: (1) x 1360 kg (3000 lb)
- (0) slabs installed on turret: no slabs installed

Slewing

Continuous 360° rotation using (a) low-speed, high-torque motor with a manually adjustable swing adjustment valve integrated to the hydraulic motor control manifold mounted to a planetary reduction gear. A proportional electronic brake pedal located in the operator cab allows for the dynamic application of the multi-disk swing brake circuit. A separate spring-applied, hydraulic-released brake for disabling rotation can be activated from the left-hand seat armrest. Free-swing functionality is disabled when using the optional crane radio remote control.

Hydraulic system

Efficient closed-center, load-sense hydraulics system featuring flow-sharing technology allowing for smooth multifunction operation of all crane functions. One (1) SAE-C mounted, 130cc axial piston pump for all functions and optimized system performance. Shaft input of 2200 rpm, generating 288 lpm (76 gpm) max flow at 310 bar (4500 psi) max operating pressure. 143 gal (541 L) hydraulic reservoir with SAE o-ring connections and integrated butterfly shut-off valve for easy maintenance. SAE o-ring hydraulic fittings and hoses throughout. Boom lift, boom telescope, main and aux hoist(s), and vertical outrigger jacks are all equipped with counterbalance valves for controlled movement and load holding.

Hydraulic oil cooler: standard electric fan, plate- and fin-style oil cooler mounted in the rear of the superstructure to remove heat from the hydraulic oil under heavy operating conditions.

Electrical system

Automotive grade, fully wire harnessed 12VDC electrical system using state-of-the-art sealed connectors and control modules. Dual-tone backup and outrigger motion alarm located at rear of machine. LED marker and triple ID lights.

Lower

Chassis mounting

Torsion-resistant, high-strength steel sub frame attached using high-strength steel mounting brackets that are welded to the sub-frame and bolted to the truck chassis using Huck® bolts to ensure a secure and maintenance-free connection. Rear bumper under ride protection standard. Fixed boom rest mounted to front outrigger box and fabricated from structural steel.

Outriggers

Out- and down-style outriggers at both the front and rear with individual control of each horizontal beam extension and vertical jack cylinder. Each outrigger jack is equipped with a 500 m (19.7 in) polymeric outrigger float standard. Horizontal beams are non-proportional and can be pinned in (4) different configurations for operation. Front outriggers are angled toward the truck cab, minimizing the need for an SFO. Ground-level control stations located at the left and right side for all vertical jacks and only the horizontal beams for each station. Operator cab features an electronic keypad mounted on the front console to control all outrigger functions.

100% span: Front = 7,09 m (23 ft 3 in)

Rear = 7,39 m (24 ft 3 in)

75% span: Front = 5,9 m (19 ft 4 in)

Rear = 6,12 m (20 ft 1 in)

Note: 75% span available ONLY with the NTC Performance Package.

50% span: Front = 4,72 m (15 ft 6 in)

Rear = 4,90 m (16 ft 1 in)

0% span: Front and Rear = 2,39 m (7 ft 10 in)

Outrigger monitoring system for horizontal beam extension is standard. Inverted cylinder rods for vertical outrigger jack cylinders for best protection of chromed rod. Optional single front outrigger (SFO) is available for heavy front axle mounting configurations.

Specifications

Optional items

• NTC Performance Package (NTC50L/NTC55L)

- > Four-position outriggers
- > Wireless windspeed sensor package
- > NTC50L and NTC55L model designation decals and materials

• Operator aids

- > Six-function wireless radio remote control of approximately 75 m (250 ft) (NB6R)

• Telescopic offsettable jib

- > 7,9 m – 13,7 m (26 ft – 45 ft) telescoping boom extension (side fold for stowing), includes 5,8 m (19 ft) manual pull out section
- > Max tip height of 61,9 m (203 ft)
- > Offsets of 0° and 30°
- > RCL calibration for future jib option

• Lattice fixed offsettable jib

- > 11 m (36 ft) fixed boom extension (side fold for stowing)
- > Max tip height of 59,1 m (194 ft)
- > Offsets of 0°, 15° and 30°
- > RCL calibration for future jib option

• Auxiliary hoist

- > A second turret-mounted hoist located to the rear of the standard main hoist
- > Standard with rotation-resistant wire rope and round, top-swivel downhaul weight

• Personnel handling platforms

- > (2) person steel, non-insulated, platform options
- > Rapid Attach Platform system available in both the rotating (R-RAP2) and yoke-style (Y-RAP2) options
- > Capacities up to 544,3 kg (1200 lb) on main boom and 226,8 kg (500 lb) on jib
- > Platform test weight sets available for each
- > Compliant to ASME B30.23 requirements

• K100™ synthetic rope

- > 137,2 m (450 ft) 18 mm (0.71 in) K100™ synthetic hoist rope (in lieu of standard rope)
- > Available for either main, aux or both hoists
- > 80% lighter than steel wire rope with same available linepull
- > Easy handling/reaving and installation
- > Reduces number of change outs due to mitigation of kinking, birdcaging or damage from diving
- > Corrosion resistant — no rusting, no lubrication requirements

• Wireless windspeed sensor

- > Real-time feedback of current speed
- > Display on in-dash RCL display and on optional wireless radio remote

• Camera package

- > Camera package offering visibility of the rear quadrant of the machine including counterweight area and view of the hoist(s)
- > Video camera at hoist location
- > Rearview video camera on rear of turntable providing a 170-degree view angle enabling operator to see outriggers fully deployed and then some for enhanced jobsite visibility

• Hook blocks

- > Single sheave, 18,1 t (20 USt) quick-reeve hook block for 2-3 part reeving [186 kg (410 lb)]
- > Triple sheave, 36,3 t (40 USt) quick-reeve hook block for 4-7 part reeving including auxiliary sheave case assembly (272 kg [600 lb])
- > Five sheave, 49,9 t (55 USt) quick-reeve hook block for 8-10 part reeving including auxiliary sheave case assembly (498 kg [1098 lb])

• Single Front Outrigger

- > 63,5 m (25 in) vertical stroke
- > Available for certain mounting configurations

• Aluminum outrigger floats

- > 610 mm (24 in) aluminum floats in lieu of the standard 500 mm (19.7 in) polymeric floats

Specifications



Main and (optional) auxiliary hoist(s)

Two-speed displacement, bent-axis piston motor driving a planetary gearset and a grooved drum with cable tensioner/follower, drum rotation indicator, and last layer and minimum wrap indicators.

Parts of Line	1 part line	2 part line	3 part line	4 part line	5 part line	6 part line	7 part line	8 part line	9 part line	10 part line	11 part line
Max boom length (ft) at max elevations with stated rigging and load block and ground level	196 (includes 45 ft ext.)	144	108	84	72	60	48	36.8	36.8	36.8	36.8
Low speed lift (lb)	11,280	22,500	33,750	45,000	56,250	67,500	78,750	90,000	100,000	111,250	110,000
High speed lift (lb)	5000	10,000	15,000	20,000	25,000	30,000	35,000	40,000	45,000	50,000	55,000

Line Pulls and Reeving Information			
Hoists	Cable specs.	Permissible line pulls	Nominal cable length
Main and Auxiliary	16 mm (5/8 in) Dyform 34 LR Rotation Resistant (non-rotating) Min. Breaking Strength 56,420 lb	11,280 lb*	498 ft (152 m)
Main and Auxiliary	18 mm Synthetic K-100™ Hoist Rope (ISO) Min. Breaking Strength 63,700 lb	12,740 lb*	498 ft (152 m)

The approximate weight of 5/8 in wire rope is 1.0 lb/ft.

The approximate weight of 18 mm synthetic rope is 0.16 lb/ft.

*With certain boom and hoist tackle combinations, the allowable line pull may be limited by hoist performance. Refer to Hoist Performance table for lift planning to ensure adequate hoist performance on drum rope layer required.

Hoist Performance				
Wire rope layer	Hoist line pulls		Drum capacity (ft)	
	Two speed hoist		Layer	Total
	Low	High		
	Available lb	Available lb		
1	17,250	7040	78	78
2	15,450	6310	87	165
3	14,000	5720	96	261
4	12,790	5220	105	366
5	11,780	4810	114	480

*Refer to Line Pulls and Reeving Information table for max. lifting capacity of wire rope.

Synthetic rope layer height may vary and may reduce available line pull per layer.

Weight Reductions for Load Handling Devices	
Auxiliary boom nose (single sheave)	35,5 kg (78.1 lb)
Auxiliary boom nose (double sheave)	44,3 kg (97.7 lb)
Hook blocks and headache balls	
55 USt, 5-sheave (14 in sheave) CE	498,0 kg (1098 lb)+
40 USt, 3-sheave (12 in sheave)	272,2 kg (600 lb)+
20 USt, 1-sheave	204 kg (450 lb)+
7 USt overhaul ball	163,7 kg (250 lb)+

+ Refer to rating plate for actual weight

When lifting over boom extension, deduct total weight of all load handling devices reeved over main boom nose directly from boom extension capacity.

NOTE: All load handling devices and boom attachments are considered part of the load and suitable allowances MUST BE MADE for their combined weights. Weights are for Manitowoc furnished equipment.

Symbols glossary



Boom



Chassis



Extension



Outriggers



Boom elevation



Counterweight



Extension



Radius



Boom extension



Crane control system



Hoist



Rotation



Cab



Electrical system



Hydraulic system

Notes

The Manitowoc Company, Inc.

Regional headquarters

Americas

Milwaukee, Wisconsin, USA

Tel: +1 414 760 4600

Shady Grove, Pennsylvania, USA

Tel: +1 717 597 8121

Europe and Africa

Dardilly, France - TOWERS

Tel: +33 (0) 4 72 18 20 20

Wilhelmshaven, Germany - MOBILE

Tel: +49 (0) 4421 294 0

APAC

Shanghai, China

Tel: +86 21 6457 0066

Singapore

Tel: +65 6264 1188

Middle East and India

Dubai, UAE

Tel: +971 4 8862677

This document is non-contractual. Constant improvement and engineering progress make it necessary that we reserve the right to make specification, equipment, and price changes without notice. Illustrations shown may include optional equipment and accessories and may not include all standard equipment.

©2022 The Manitowoc Company, Inc.
Form No. NBT50L Series PG
Part No. 18-003/PDF/1022



www.manitowoc.com