

MLC165-1

Product Guide

ASME B30.5
Metric



Features

- 165 t capacity
- 762 m-kg maximum load moment
- 84 m main boom
- Max boom + fixed jib combination:
69 m + 24,4 m
- Max boom + luffing jib combination:
51 m + 51,8 m
- 231 kW Tier 4 Final engine
- 242 kW Tier 3 engine

MANITOWOC MLC165-1

The MLC165-1 provides a broad range of features that will undoubtedly be translated into jobsite benefits that increase productivity and save money.

Features

> Crawler Connection

Each crawler is FACT™ aligned and securely fastened to the carbody with hydraulic powered pins for fast, easy assembly. Hydraulic connections utilize screw style quick disconnect couplers.



> Counterweight

Single part number for upperworks counterweight can be stacked in any order and raised into position using optional self-assembly counterweight raising cylinders. Counterweight tray is retained in position using hydraulic powered pins with incorporated locking system for quick and hassle-free installation.



> Asset Utilization

The MLC165-1 is able to be equipped with attachments that are already in common in the field. The No. 134 fixed jib has been used on the 777, 888, 999, 14000 and MLC165. In addition the No. 135 luffing jib has been used on the 888, 999, 14000 and MLC165.

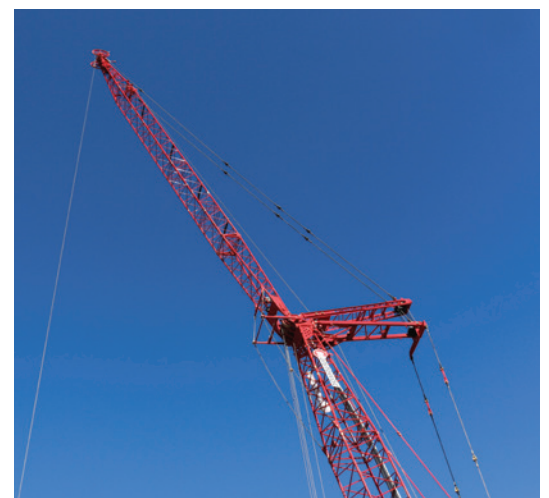

CraneSTAR®

> CraneSTAR is an exclusive and innovative crane asset management system

that helps improve your profitability and reduce costs by remotely monitoring critical crane data.

Visit www.cranestar.com for more information.

Jobsite benefits

Increased productivity

The MLC165-1 delivers superior performance to finish the job quicker.

- 12 500 kg single line pull and 135 m/min maximum line speed
- 2,5 rpm swing speed
- Travel, swing and counter-rotate with full rated capacity



Rugged durability and ease of service

The MLC165-1 comes equipped with numerous upgrades to spend less time performing maintenance.

- Individual function hour tracking to optimize service intervals
- Remote mounted filters for easy access inside enclosures
- Sealed intermediate rollers eliminating the need for greasing

Easy and quick assembly

The MLC165-1 helps you spend less time on the truck and more time on the job.

- Raise full boom and luffing jib combinations without assist
- Self-erect mast cylinder eliminates need to reeve self assembly block
- Ability to completely self assemble machine without an assist crane



Manitowoc Crane Care when you need it.
The assurance of the world's most advanced crane service and support to get you back to work fast.



Manitowoc Finance helps you get right to work generating profits for your business.
Financial tools that help you capitalize on opportunity with solutions that fit your needs.

Contents

Outline dimensions	5
Transport data	11
Performance data	12
Boom combinations	14
Working range/load charts – Main boom	16
Working range/ load charts – Fixed jib	18
Working range/ load charts – Luffing jib	21
Specifications	23
Symbols glossary	25

Outline dimensions

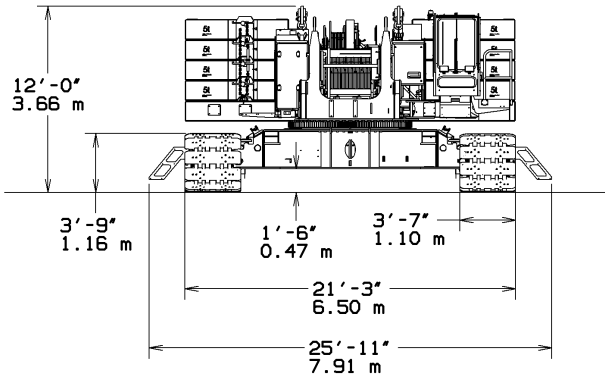
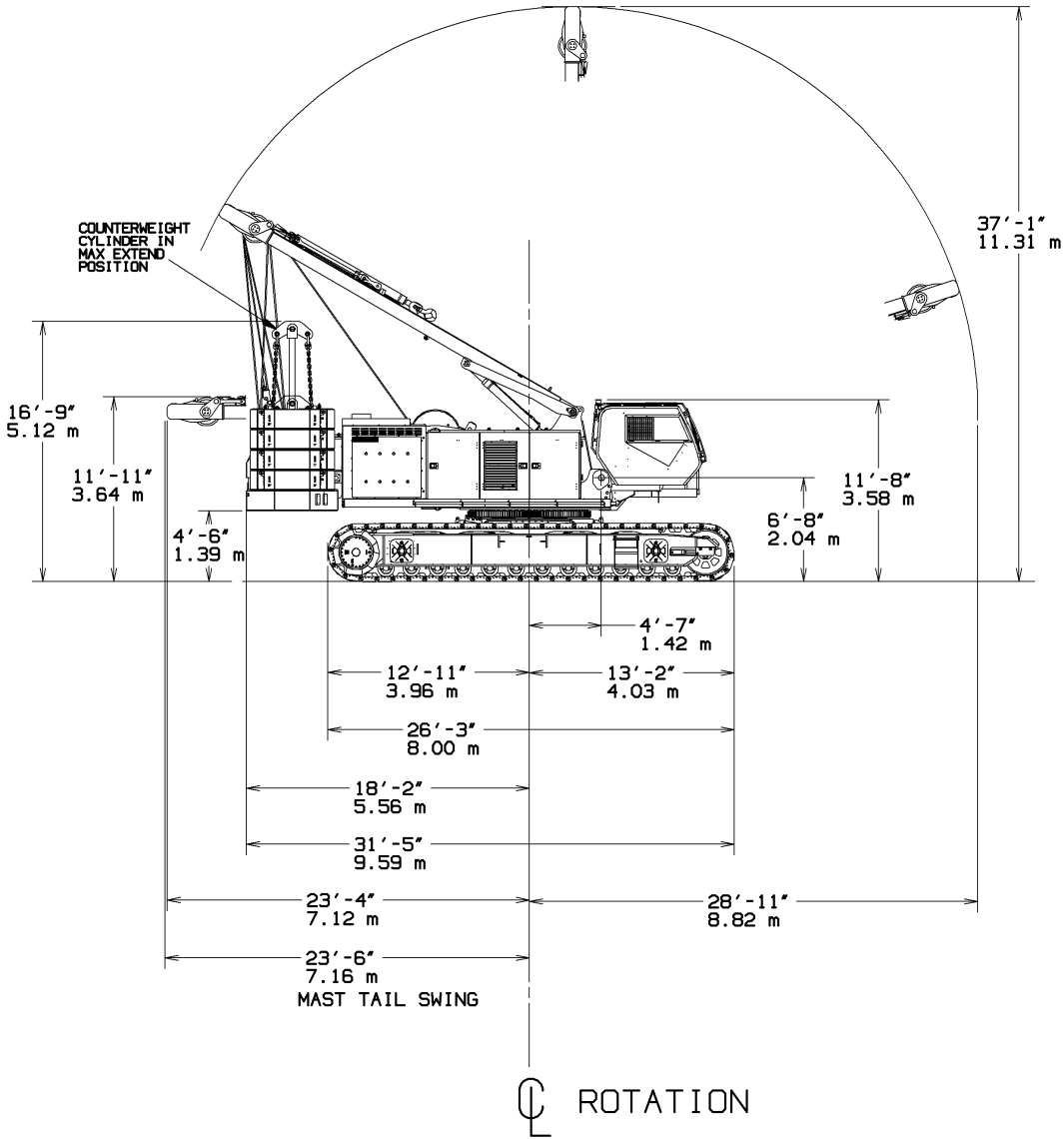

Outline dimensions

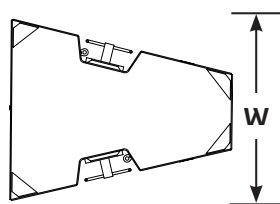
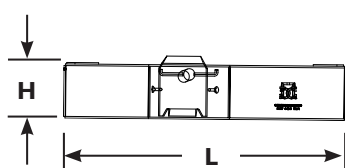
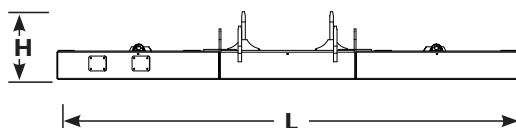
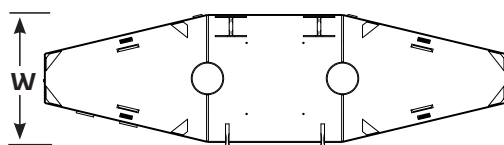
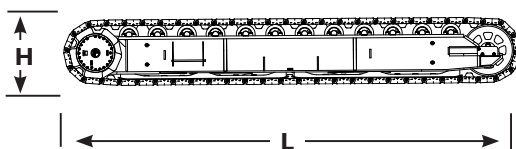
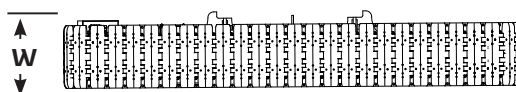
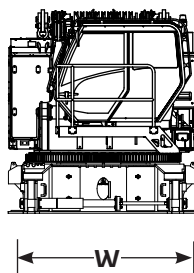
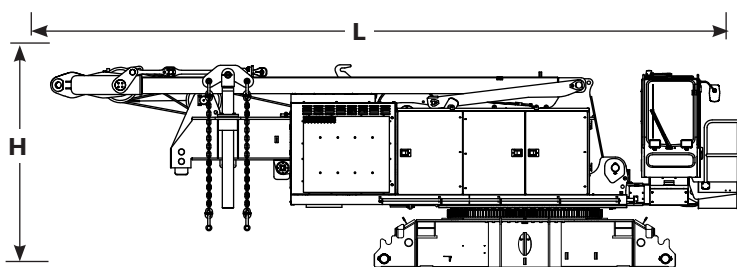

Basic crane	
Length	10,5 m
Width	3,0 m
Height	3,2 m
Weight	34 900 kg

Note: Weight includes carbody, upperworks with two full power drums, operator's cab, mast with self-erect cylinder, boom-hoist wire rope, maximum hoist and whip lines on drums, optional self-assembly jacks, full hydraulic fluid reservoir, and half tank of fuel.

Crawlers	
Length	8,0 m
Width	1,3 m
Height	1,1 m
Weight	14 900 kg

Counterweight tray	
Length	6,5 m
Width	1,9 m
Height	0,9 m
Weight	16 000 kg

Upper side counterweight	
Series 1	x 6
Series 2	x 8
Length	2,0 m
Width	1,7 m
Height	0,4 m
Weight	5000 kg

Outline dimensions

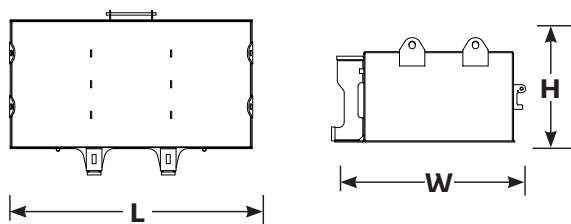

Lower carbody counterweight Series 2	
	x 2
Length	2,5 m
Width	1,7 m
Height	0,9 m
Weight	10 200 kg

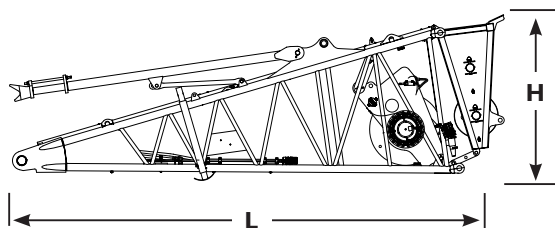

6,0 m No. 74A boom butt, wire rope guide and boom stop	
Length	6,9 m
Width	2,1 m
Height	2,3 m
Weight	5000 kg

Note: without aux drum – 2 700 kg

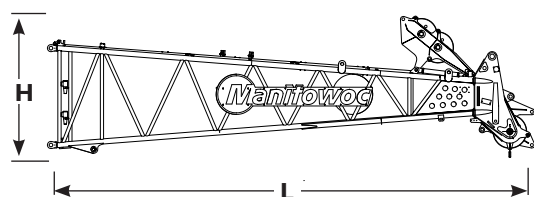

9,0 m No. 74A boom top, wire rope guide and straps	
Length	9,6 m
Width	2,0 m
Height	2,6 m
Weight	2500 kg

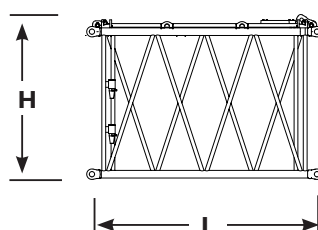

3,0 m No. 74A boom insert and straps	
Length	3,2 m
Width	2,0 m
Height	2,2 m
Weight	600 kg

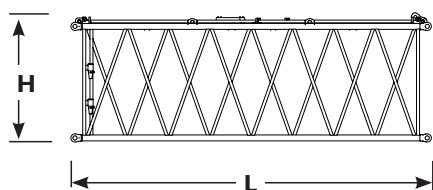

6,0 m No. 74A boom insert and straps	
Length	6,2 m
Width	2,0 m
Height	2,2 m
Weight	1000 kg

Outline dimensions

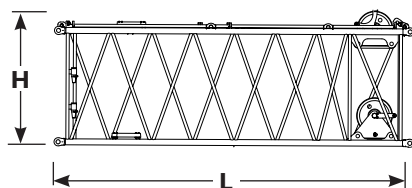

6,0 m No. 74A boom insert with sheaves and straps	
Length	6,2 m
Width	2,0 m
Height	2,4 m
Weight	1400 kg

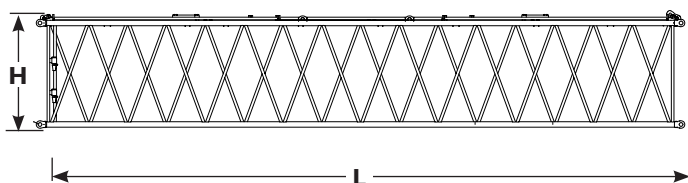

12,0 m No. 74A boom insert and straps	
Length	12,2 m
Width	2,0 m
Height	2,2 m
Weight	1700 kg

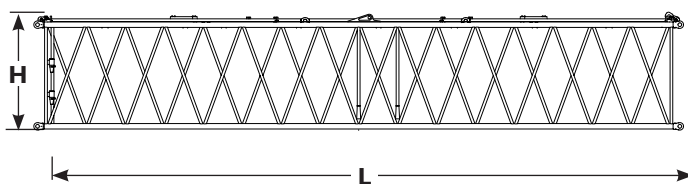

12,0 m No. 74A boom insert with backstay lugs and straps	
Length	12,2 m
Width	2,0 m
Height	2,2 m
Weight	1800 kg

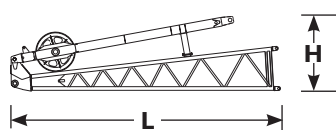

4,6 m No. 134 jib butt, strut and stop	
Length	4,7 m
Width	0,9 m
Height	1,3 m
Weight	600 kg

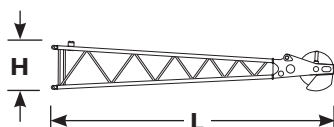

4,6 m No. 134 jib top and pendants	
Length	5,0 m
Width	0,8 m
Height	0,8 m
Weight	500 kg

Outline dimensions

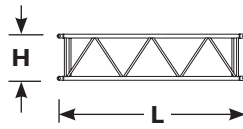

3,0 m No. 134 jib insert and pendants

Length	3,1 m
Width	0,8 m
Height	0,8 m
Weight	200 kg

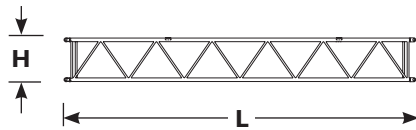

6,1 m No. 134 jib insert and pendants

Length	6,2 m
Width	0,8 m
Height	0,8 m
Weight	300 kg

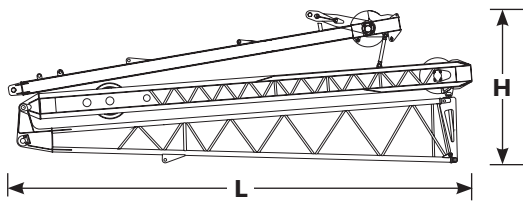

8,2 m No. 135 luffing jib butt and struts

Length	8,8 m
Width	1,6 m
Height	3,0 m
Weight	4500 kg

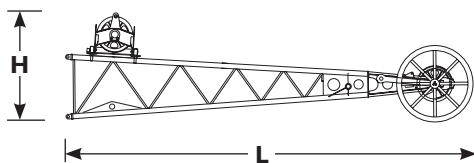

7,0 m No. 135 luffing jib top, roller and pendants

Length	7,8 m
Width	1,5 m
Height	2,0 m
Weight	2100 kg

Note: Includes wire rope guide.

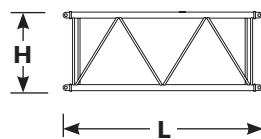

3,0 m No. 135 luffing jib insert and pendants

Length	3,1 m
Width	1,5 m
Height	1,3 m
Weight	400 kg

Outline dimensions

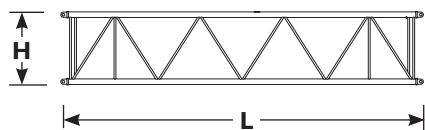

6,1 m No. 135 luffing jib insert and pendants	
Length	6,2 m
Width	1,5 m
Height	1,3 m
Weight	700 kg

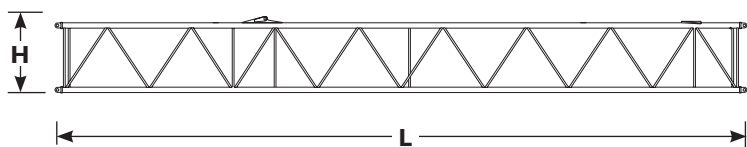

12,2 m No. 135 luffing jib insert with backstays and pendants	
Length	12,3 m
Width	1,5 m
Height	1,3 m
Weight	1300 kg

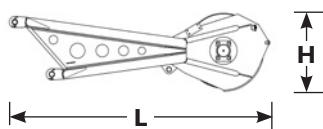

No. 74A upper boom point	
Length	2,6 m
Width	0,4 m
Height	0,8 m
Weight	500 kg

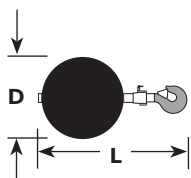

Weight ball			
Capacity/Swivel	13,6 t	Diameter	1,1 m
Weight	600 kg	Length	0,5 m

Transport data

Load summary										
Item	84 m No. 74A boom + 24,4 m No. 134 fixed jib Series 2 counterweight Quantity on trailer load # (Does not include blocking, strapping, etc.)									
	Qty	kg	1	2	3	4	5	6	7	8
Basic Crane	1	34 900	1	—	—	—	—	—	—	—
Crawler	2	14 900	—	1	1	—	—	—	—	—
Counterweight Tray	1	16 000	—	—	—	—	—	—	—	1
Side Counterweight	8	5 000	—	—	—	1	1	3	3	—
Carbody Counterweight	2	10 200	—	—	—	1	1	—	—	—
6 m No. 74A Boom Butt with aux drum	1	5 000	—	—	—	—	1	—	—	—
9 m No. 74A Boom Top	1	2 500	—	—	—	1	—	—	—	—
3 m No. 74A Boom Insert	1	600	—	—	—	—	—	—	—	1
6 m No. 74A Boom Insert	1	1 000	—	1	—	—	—	—	—	—
6 m No. 74A Boom Insert with Sheaves	1	1 400	—	—	1	—	—	—	—	—
12 m No. 74A Boom Insert	2	1 700	—	—	—	—	—	1	1	—
Miscellaneous	1	2 300	—	—	—	—	1	—	—	—
Payload for each trailer (kg)			34 900	15 900	16 300	17 700	22 500	16 700	16 700	16 600

Performance data

Main and whip drum – 12 500 kg						
Single line pull kg	Single line speed m/min					
	Layer					
	1	2	3	4	5	6
0	96	103	111	119	127	135
12 500	67	72	78	83	89	95

Luffing hoist auxiliary drum – 9070 kg								
Single line pull kg	Single line speed m/min							
	Layer							
	1	2	3	4	5	6	7	8
9070	41	44	48	51	55	58	62	65

Hoist reeving for main load block 26 mm wire rope No. 74A boom	
No. Parts of Line	Maximum Load
	kg
1	12 500
2	25 000
3	37 500
4	50 000
5	62 500
6	75 000
7	87 500
8	100 000
9	112 500
10	125 000
11	137 500
12	150 000
13	162 500
14	165 000

Wire rope lengths No. 74A boom - or - Fixed jib No. 134 on No. 74A boom				
Boom or boom and jib length	Whip line (front or auxiliary drum)		Hoist line (rear drum)	
	1 part	2 part		Total parts of line
m	m	m	m	
15,0	45	65	250	14
18,0	55	75	275	13
21,0	60	85	295	12
24,0	65	90	310	11
27,0	70	100	320	10
30,0	75	110	320	9
33,0	85	120	350	9
36,0	90	130	345	8
39,0	95	135	370	8
42,0	100	145	355	7
45,0	105	155	380	7
48,0	115	165	355	6
51,0	120	175	375	6
54,0	125	180	340	5
57,0	130	190	360	5
60,0	135	200	380	5
63,0	145	210	330	4
66,0	150	220	345	4
69,0	155	225	290	3
72,0	160	235	305	3
75,0	165	245	315	3
78,0	175	255	325	3
81,0	180	260	340	3
84,0	185	270	265	2
87,0	190	275	—	—
90,0	195	280	—	—
93,0	200	—	—	—

NOTE: Hoist and whip line lengths given in table will allow hook to touch ground. When block travel below ground is required, add additional rope equal to parts of line times added travel distance. Hoisting distance or line pull may be limited when block travel below ground is required.

Maximum wire rope length on auxiliary drum when used as Whip Line is 190 m. When auxiliary drum is used as Luffing Jib Hoist, wire rope length required on drum is 210 m. If auxiliary drum is used as Whip Line while equipped with 210 m rope length, hoisting distance and line pull will be limited. Consult factory for further information.

Performance data

Wire rope lengths No. 135 luffing jib on No. 74A boom

Boom length*	Luffing jib hoist line	
	Hoist line	Maximum required parts of line
m	m	
21,0	259	4
24,0	274	4
27,0	290	4
30,0	305	4
33,0	305	4
36,0	320	4
39,0	320	4
42,0	335	4
45,0	335	3
48,0	335	3
51,0	351	3

*Hoist line lengths given in table include all luffing jib lengths.

NOTE: Hoist line lengths given in table will allow hook to touch ground. When block travel below ground is required, add additional rope equal to parts of line multiply by added travel distance. Hoisting distance or line pull may be limited when block travel below ground is required.

Wire rope specifications 5:1 Safety Factor No. 74A boom - or - No. 134 fixed jib on No. 74A boom

Rotation resistant Wire rope			
Drum / Rope size	Front end 26 mm	Rear end 26 mm	Aux end 26 mm
Max load per line, kg	12 500	12 500	9 070
Approx weight, kg/m	3,41	3,41	3,41

Drum capacities – wire rope

	Maximum length	
	Operational	Storage
Front or rear grooved drum 26 mm wire rope	374 m 6 layers	457 m 7 layers
Auxiliary drum 26 mm wire rope	164 m 7 layers	233 m 9 layers
Boom hoist drum 22 mm wire rope	170 m 7 layers	—

For specific configurations refer to www.cranelibrary.com.

Boom combinations

No. 74A boom combinations			
Boom length m	Boom inserts length m		
	3	6	12
15	0	0	0
18	1	0	0
21	0	1	0
24	1	1	0
27	0	2	0
30	1	2	0
33	0	1	1
36	1	1	1
39	0	2	1
42	1	2	1
45	0	1	2
48	1	1	2
51	0	2	2
54	1	2	2
57	0	1	3
60	1	1	3
63	0	2	3
66	1	2	3
69	0	1	4
72	1	1	4
75	0	2	4
78	1	2	4
81	0	1	5
84	1	1	5

No. 134 fixed jib combinations		
Fixed jib length m	Fixed jib inserts length m	
	3,0	6,1
9,1	0	0
12,2	1	0
15,2	0	1
18,3	1	1
21,3	0	2
24,4	1	2

*With fixed jib backstay assembly.

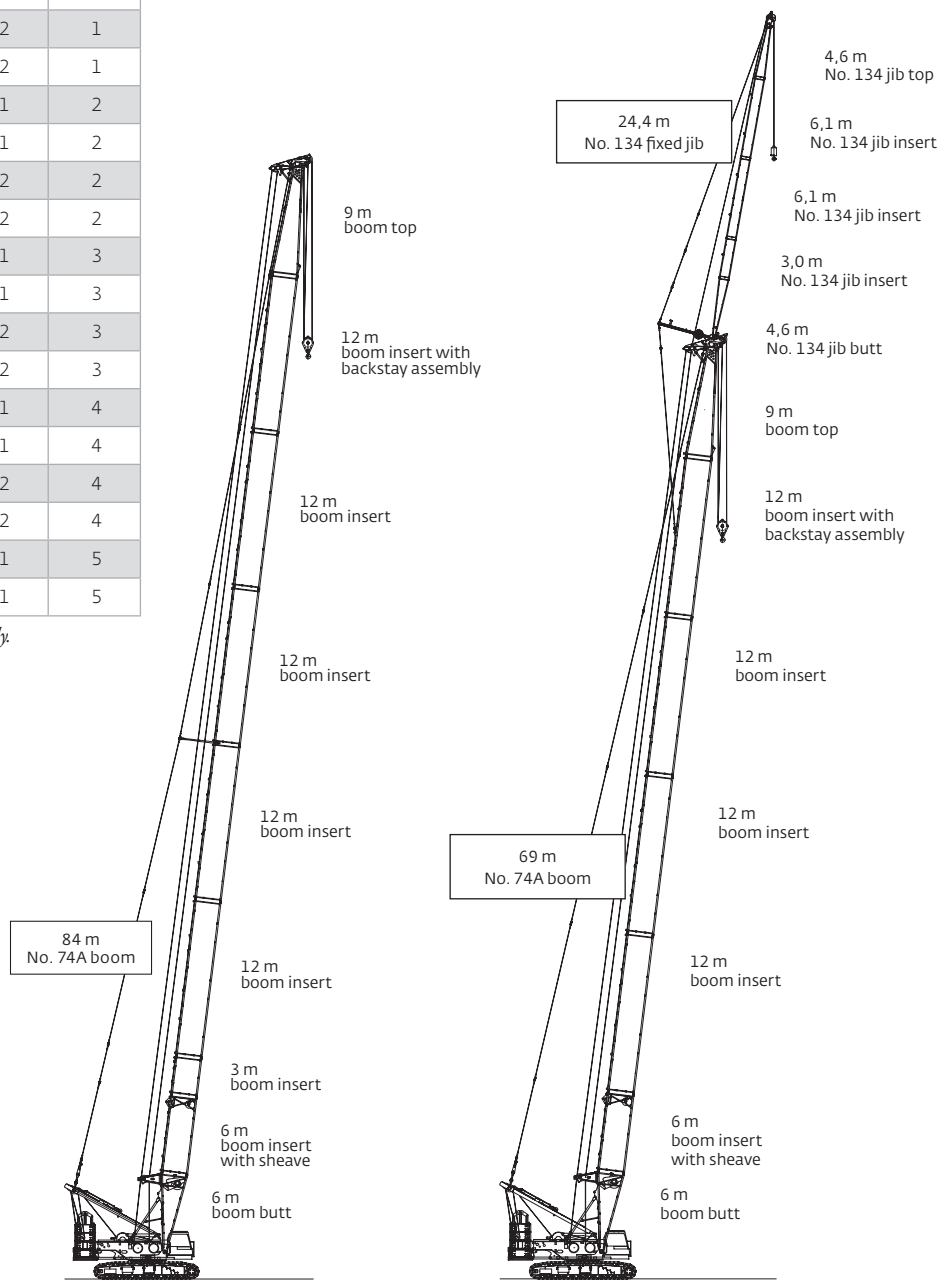

Boom combinations

No. 135 luffing jib combinations			
Luffing jib length m	Luffing jib inserts length m		
	3,1	6,1	12,1
21,3	0	1	0
24,4	1	1	0
27,4	0	0	1
30,5	1	0	1
33,5	0	1	1
36,6	1	1	1
39,6	0	0	2
42,7	1	0	2
45,7	0	1	2
48,8	1	1	2
51,8	0	0	3

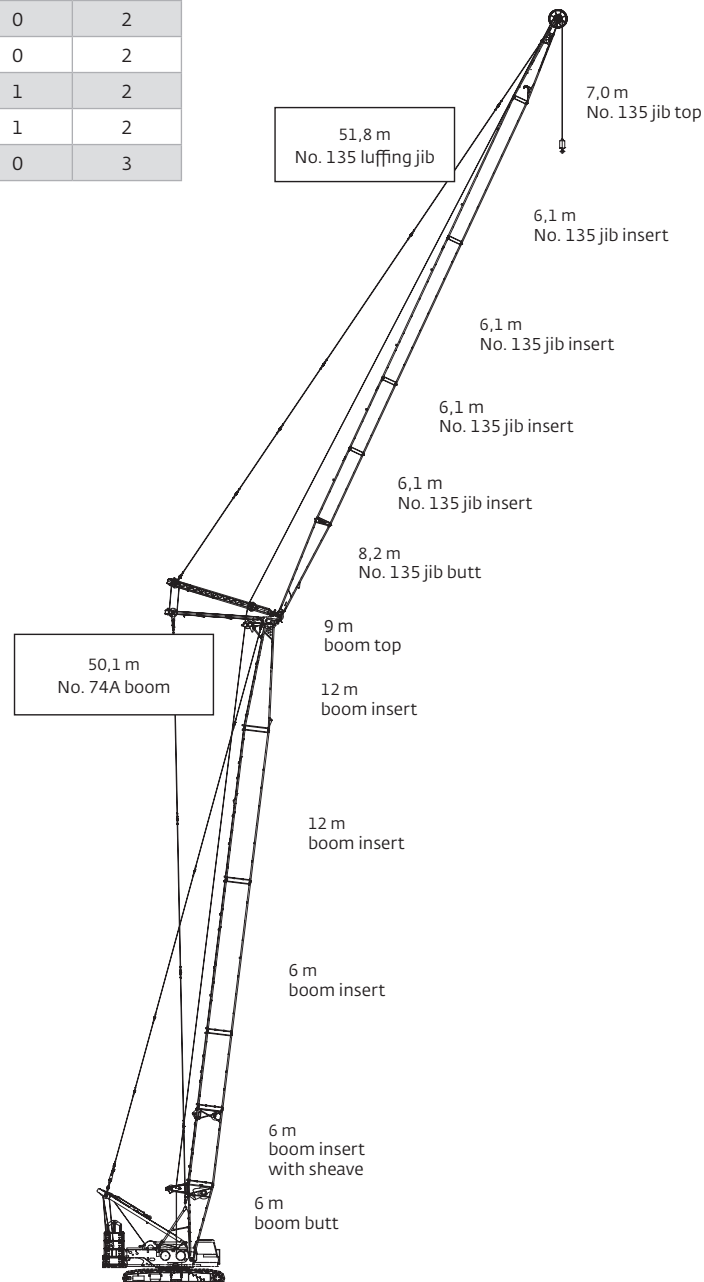

Main boom range diagram

No. 74A boom

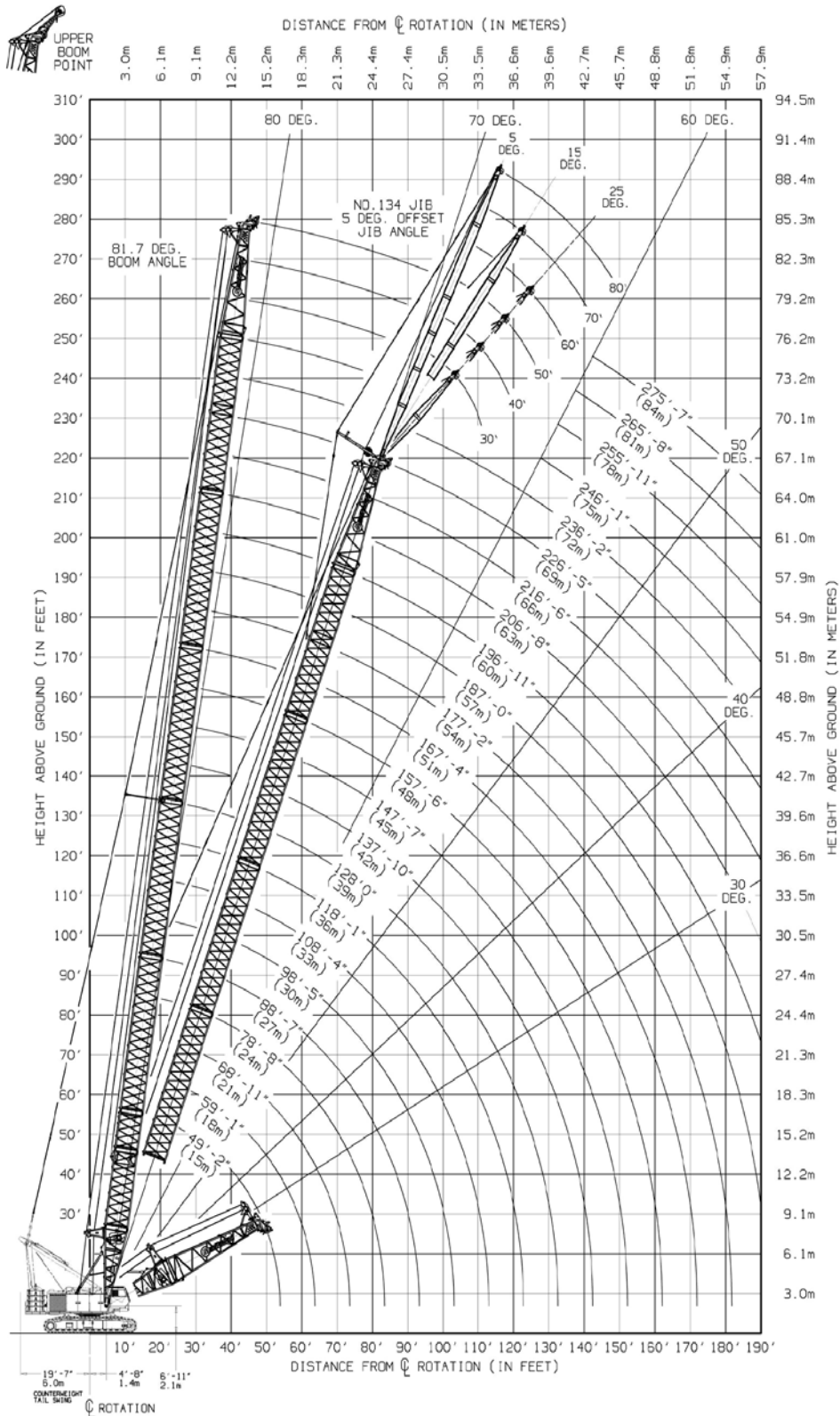

THIS CHART IS ONLY A GUIDE AND SHOULD NOT BE USED TO OPERATE THE CRANE.

The individual crane's load chart, operating instructions and other instructional plates must be read and understood prior to operating the crane

Main boom load chart

No. 74A boom													
56 000 kg upper counterweight, 20 450 kg carbody counterweight													
360° Rating kg x 1000													
Radius m	Boom length m												
	15	18	24	30	36	42	48	54	60	66	72	78	84
4,3	165,0	—	—	—	—	—	—	—	—	—	—	—	—
5	149,6	148,9	—	—	—	—	—	—	—	—	—	—	—
6	125,9	125,8	125,4	—	—	—	—	—	—	—	—	—	—
7	108,5	108,5	108,0	108,0	—	—	—	—	—	—	—	—	—
8	94,9	94,9	94,5	94,3	94,2	—	—	—	—	—	—	—	—
9	78,6	78,8	78,7	78,8	78,8	78,3	—	—	—	—	—	—	—
10	67,1	67,3	67,1	67,2	67,1	67,0	67,7	—	—	—	—	—	—
11	58,4	58,5	58,4	58,4	58,4	58,2	58,3	58,2	51,9	—	—	—	—
12	51,6	51,7	51,6	51,6	51,5	51,3	51,4	51,2	50,5	—	—	—	—
13	46,1	46,2	46,1	46,1	46,0	45,8	45,9	45,7	45,5	40,0	35,9	—	—
14	41,5	41,7	41,6	41,5	41,5	41,3	41,4	41,1	40,9	39,3	35,8	29,6	—
15	37,7	37,9	37,8	37,7	37,7	37,5	37,5	37,3	37,1	37,0	35,6	29,5	24,8
16	—	34,7	34,5	34,5	34,4	34,3	34,3	34,1	33,9	33,6	34,1	29,4	24,7
18	—	29,4	29,4	29,4	29,3	29,1	29,1	28,9	28,7	28,4	28,0	27,7	24,5
20	—	—	25,4	25,4	25,3	25,1	25,2	24,9	24,7	24,4	24,0	23,7	23,6
22	—	—	22,2	22,3	22,2	22,0	22,0	21,8	21,5	21,3	20,8	20,5	20,2
24	—	—	19,6	19,7	19,6	19,4	19,5	19,2	19,0	18,7	18,2	18,0	17,7
26	—	—	—	17,6	17,5	17,3	17,3	17,1	16,9	16,6	16,1	15,8	15,5
28	—	—	—	15,8	15,7	15,5	15,6	15,3	15,1	14,8	14,3	14,0	13,7
30	—	—	—	14,2	14,2	14,0	14,0	13,8	13,5	13,3	12,8	12,5	12,2
32	—	—	—	—	12,9	12,7	12,7	12,5	12,2	11,9	11,5	11,2	10,9
34	—	—	—	—	11,7	11,5	11,6	11,3	11,1	10,8	10,3	10,0	9,7
36	—	—	—	—	—	10,5	10,6	10,3	10,1	9,8	9,3	9,0	8,7
38	—	—	—	—	—	9,6	9,7	9,4	9,2	8,9	8,4	8,1	7,8
40	—	—	—	—	—	8,8	8,9	8,6	8,4	8,1	7,6	7,3	7,0
42	—	—	—	—	—	—	8,1	7,9	7,6	7,4	6,9	6,6	6,3
44	—	—	—	—	—	—	7,5	7,2	7,0	6,7	6,2	5,9	5,6
46	—	—	—	—	—	—	6,9	6,6	6,4	6,1	5,6	5,3	5,0
48	—	—	—	—	—	—	—	6,1	5,9	5,6	5,1	4,8	4,5
50	—	—	—	—	—	—	—	5,6	5,4	5,1	4,6	4,3	4,0
52	—	—	—	—	—	—	—	5,1	4,9	4,6	4,1	3,8	3,5
54	—	—	—	—	—	—	—	—	4,5	4,2	3,7	3,4	3,0
56	—	—	—	—	—	—	—	—	4,1	3,8	3,3	3,0	2,5
58	—	—	—	—	—	—	—	—	3,7	3,4	3,0	2,5	2,1
60	—	—	—	—	—	—	—	—	—	3,1	2,6	2,1	1,7
62	—	—	—	—	—	—	—	—	—	2,8	2,2	1,8	—
64	—	—	—	—	—	—	—	—	—	2,5	1,9	1,4	—
66	—	—	—	—	—	—	—	—	—	—	1,5	—	—

THIS CHART IS ONLY A GUIDE AND SHOULD NOT BE USED TO OPERATE THE CRANE.

The individual crane's load chart, operating instructions and other instructional plates must be read and understood prior to operating the crane

Fixed jib range diagram

No. 134 fixed jib on No. 74A boom

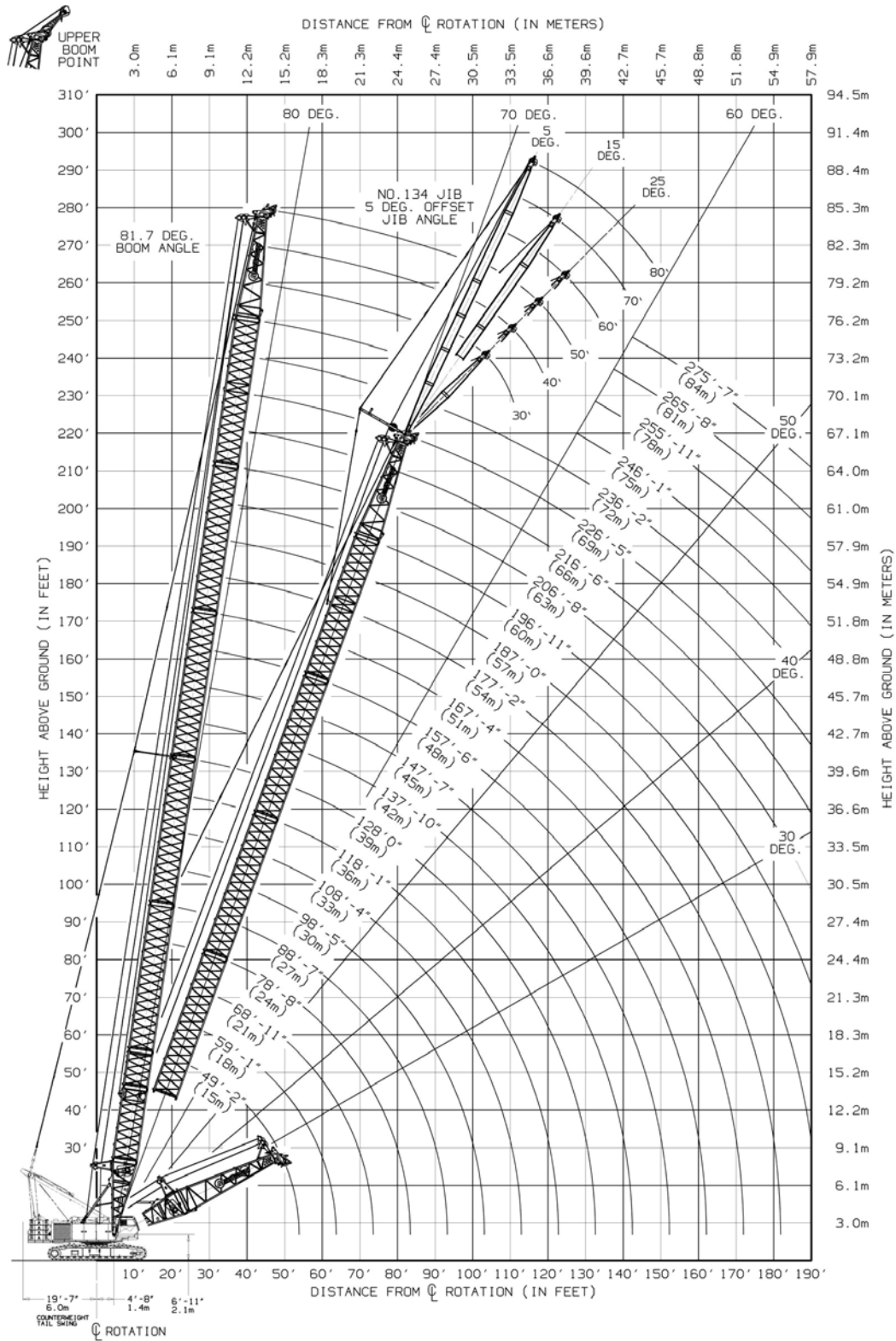

THIS CHART IS ONLY A GUIDE AND SHOULD NOT BE USED TO OPERATE THE CRANE.

The individual crane's load chart, operating instructions and other instructional plates must be read and understood prior to operating the crane

Fixed jib load charts

9,1 m No. 134 fixed jib on No. 74A boom

56 000 kg upper counterweight, 20 450 kg carbody counterweight

360° Rating

kg x 1000

Radius m	Boom length m														
	27			39			51			63			75		
	5°	15°	25°	5°	15°	25°	5°	15°	25°	5°	15°	25°	5°	15°	25°
10,7	—	25,0	—	—	—	—	—	—	—	—	—	—	—	—	—
12	21,0	25,0	21,0	—	—	—	—	—	—	—	—	—	—	—	—
14	19,7	25,0	19,7	—	25,0	—	—	—	—	—	—	—	—	—	—
16	18,4	24,9	18,4	20,1	25,0	20,1	—	25,0	—	—	—	—	—	—	—
18	17,3	24,6	17,3	19,1	25,0	19,1	20,4	24,9	20,4	—	—	—	—	—	—
20	16,4	24,1	16,4	18,2	24,6	18,2	19,6	24,5	19,6	20,6	23,7	20,6	—	21,8	—
22	15,6	22,9	15,6	17,4	22,6	17,4	18,8	22,2	18,8	19,9	21,7	19,9	20,2	21,1	20,6
24	14,9	20,4	14,9	16,7	19,9	16,7	18,1	19,5	18,1	18,6	18,9	19,1	17,9	18,4	19,0
26	14,3	18,2	14,3	16,1	17,7	16,1	17,1	17,3	17,5	16,4	16,8	17,1	15,7	16,2	16,6
28	13,8	16,4	13,8	15,4	15,9	15,5	15,2	15,5	15,8	14,6	14,9	15,3	13,9	14,3	14,7
30	—	14,8	—	14,2	14,3	14,6	13,7	14,0	14,2	13,1	13,4	13,7	12,4	12,7	13,1
32	—	13,5	—	12,8	13,0	13,1	12,4	12,6	12,8	11,8	12,0	12,3	11,1	11,4	11,7
34	—	—	—	11,7	11,8	11,9	11,2	11,4	11,6	10,6	10,8	11,1	9,9	10,2	10,5
36	—	—	—	10,7	10,8	10,9	10,2	10,4	10,6	9,6	9,8	10,0	8,9	9,1	9,4
38	—	—	—	9,7	9,9	9,9	9,3	9,5	9,6	8,7	8,9	9,1	8,0	8,2	8,5
40	—	—	—	—	9,0	—	8,5	8,7	8,8	7,9	8,1	8,2	7,2	7,4	7,6
42	—	—	—	—	8,3	—	7,8	7,9	8,0	7,2	7,3	7,5	6,4	6,7	6,8
44	—	—	—	—	—	—	7,1	7,3	7,3	6,5	6,7	6,8	5,8	6,0	6,2
46	—	—	—	—	—	—	6,5	6,6	6,7	5,9	6,1	6,2	5,2	5,4	5,5
48	—	—	—	—	—	—	—	6,1	—	5,4	5,5	5,6	4,6	4,8	5,0
50	—	—	—	—	—	—	—	5,6	—	4,9	5,0	5,1	4,1	4,3	4,4
52	—	—	—	—	—	—	—	5,1	—	4,4	4,5	4,6	3,7	3,8	4,0
54	—	—	—	—	—	—	—	—	—	4,0	4,1	4,2	3,2	3,4	3,5
56	—	—	—	—	—	—	—	—	—	3,6	3,7	3,7	2,7	2,9	3,0
58	—	—	—	—	—	—	—	—	—	—	3,3	—	2,3	2,5	2,6
60	—	—	—	—	—	—	—	—	—	—	3,0	—	—	2,1	2,2
62	—	—	—	—	—	—	—	—	—	—	2,6	—	—	—	—
64	—	—	—	—	—	—	—	—	—	—	2,3	—	—	—	—

15,2 m No. 134 fixed jib on No. 74A boom

56 000 kg upper counterweight, 20 450 kg carbody counterweight

360° Rating

kg x 1000

Radius m	Boom length m														
	27			39			51			63			75		
	5°	15°	25°	5°	15°	25°	5°	15°	25°	5°	15°	25°	5°	15°	25°
10,7	20,2	—	—	—	—	—	—	—	—	—	—	—	—	—	—
12	19,7	—	—	—	—	—	—	—	—	—	—	—	—	—	—
14	19,0	17,7	—	19,3	—	—	—	—	—	—	—	—	—	—	—
16	18,4	17,2	13,4	18,8	—	—	18,7	—	—	—	—	—	—	—	—
18	17,8	16,6	12,9	18,3	17,1	—	18,3	—	—	—	—	—	—	—	—
20	17,2	16,2	12,0	17,9	16,8	13,1	17,9	16,9	—	17,4	16,5	—	16,8	—	—
22	16,6	15,2	11,3	17,5	16,4	12,5	17,6	16,6	13,3	17,1	16,3	—	16,5	15,9	—
24	16,1	14,2	10,7	17,1	16,1	11,9	17,3	16,4	12,7	16,9	16,2	13,4	16,3	15,7	—
26	15,6	13,3	10,2	16,6	15,5	11,4	16,9	16,1	12,2	16,6	16,0	12,9	16,1	15,6	12,8
28	15,1	12,5	9,7	16,0	14,7	10,9	15,6	15,7	11,8	15,0	15,5	12,5	14,5	15,2	12,5
30	14,4	11,8	9,3	14,5	13,9	10,5	14,0	14,5	11,4	13,4	13,9	12,1	12,9	13,4	12,3
32	13,5	11,2	9,0	13,2	13,2	10,1	12,7	13,1	11,0	12,1	12,5	11,7	11,5	12,0	12,0
34	12,6	10,6	8,6	12,0	12,3	9,7	11,5	11,9	10,6	10,9	11,3	11,4	10,4	10,8	11,3
36	11,6	10,2	—	11,0	11,2	9,4	10,5	10,8	10,3	9,9	10,2	10,7	9,3	9,7	10,2
38	10,7	9,8	—	10,1	10,3	9,1	9,6	9,9	10,0	9,0	9,3	9,6	8,4	8,8	9,2
40	9,9	—	—	9,3	9,5	8,9	8,8	9,0	9,3	8,1	8,5	8,8	7,6	8,0	8,3
42	—	—	—	8,5	8,7	8,7	8,1	8,3	8,5	7,4	7,7	8,0	6,9	7,2	7,5
44	—	—	—	7,9	8,0	8,2	7,4	7,6	7,8	6,7	7,0	7,3	6,2	6,5	6,8
46	—	—	—	7,3	7,4	—	6,8	7,0	7,2	6,1	6,4	6,6	5,6	5,9	6,2
48	—	—	—	6,7	6,8	—	6,3	6,4	6,6	5,6	5,8	6,0	5,0	5,3	5,6
50	—	—	—	6,2	—	—	5,7	5,9	6,0	5,1	5,3	5,5	4,5	4,8	5,0
52	—	—	—	—	—	—	5,3	5,4	—	4,6	4,8	5,0	4,1	4,3	4,5
54	—	—	—	—	—	—	4,9	5,0	—	4,2	4,4	4,5	3,6	3,9	4,1
56	—	—	—	—	—	—	4,5	4,6	—	3,8	4,0	4,1	3,2	3,5	3,6
58	—	—	—	—	—	—	4,1	—	—	3,4	3,6	3,7	2,8	3,0	3,2
60	—	—	—	—	—	—	3,7	—	—	3,1	3,2	3,4	2,4	2,6	2,8
62	—	—	—	—	—	—	3,4	—	—	2,8	2,9	—	2,0	2,2	2,4
64	—	—	—	—	—	—	—	—	—	2,5	2,6	—	—	1,9	2,0
66	—	—	—	—	—	—	—	—	—	2,1	2,3	—	—	—	—
68	—	—	—	—	—	—	—	—	—	—	1,9	—	—	—	—

THIS CHART IS ONLY A GUIDE AND SHOULD NOT BE USED TO OPERATE THE CRANE.

The individual crane's load chart, operating instructions and other instructional plates must be read and understood prior to operating the crane

Fixed jib load charts

24,4 m No. 134 fixed jib on No. 74A boom												
56 000 kg upper counterweight, 20 450 kg carbody counterweight												
360° Rating												
kg x 1000												
Radius m	Boom length m											
	27			39			51			63		
	5°	15°	25°	5°	15°	25°	5°	15°	25°	5°	15°	25°
10,67	—	—	—	—	—	—	—	—	—	—	—	—
12	10,8	—	—	—	—	—	—	—	—	—	—	—
14	10,6	—	—	—	—	—	—	—	—	—	—	—
16	10,2	—	—	10,2	—	—	—	—	—	—	—	—
18	9,9	10,0	—	9,9	—	—	9,7	—	—	—	—	—
20	9,6	9,7	—	9,6	9,7	—	9,5	—	—	9,2	—	—
22	9,3	9,4	8,4	9,4	9,5	—	9,3	9,4	—	9,0	—	—
24	9,0	9,1	7,9	9,1	9,2	8,6	9,0	9,2	—	8,8	—	—
26	8,8	8,8	7,4	8,8	9,0	8,1	8,8	9,0	8,6	8,6	8,9	—
28	8,5	8,5	6,9	8,6	8,8	7,7	8,6	8,8	8,2	8,5	8,7	8,6
30	8,3	8,2	6,6	8,4	8,6	7,3	8,4	8,7	7,9	8,3	8,6	8,4
32	8,1	8,0	6,2	8,2	8,5	7,0	8,2	8,5	7,5	8,1	8,4	8,0
34	7,9	7,7	5,9	8,0	8,3	6,6	8,0	8,3	7,2	7,9	8,3	7,7
36	7,7	7,3	5,6	7,8	8,1	6,4	7,8	8,2	7,0	7,8	8,1	7,4
38	7,4	6,9	5,4	7,6	7,9	6,1	7,6	8,0	6,7	7,6	8,0	7,2
40	7,2	6,5	5,1	7,5	7,7	5,9	7,5	7,9	6,5	7,4	7,8	7,0
42	6,9	6,2	4,9	7,3	7,5	5,6	7,3	7,8	6,2	7,3	7,7	6,7
44	6,7	5,9	4,8	7,1	7,1	5,4	7,2	7,7	6,0	6,9	7,4	6,5
46	6,5	5,7	—	7,0	6,8	5,3	7,0	7,4	5,8	6,3	6,7	6,3
48	6,3	5,5	—	6,8	6,5	5,1	6,5	6,8	5,7	5,8	6,2	6,2
50	6,0	—	—	6,5	6,3	4,9	6,0	6,3	5,5	5,3	5,6	6,0
52	—	—	—	6,0	6,1	4,8	5,5	5,8	5,3	4,8	5,2	5,5
54	—	—	—	5,6	5,8	4,7	5,1	5,3	5,2	4,4	4,7	5,0
56	—	—	—	5,2	5,4	—	4,7	4,9	5,1	4,0	4,3	4,6
58	—	—	—	4,8	5,0	—	4,3	4,5	4,7	3,6	3,9	4,2
60	—	—	—	4,5	—	—	4,0	4,2	4,3	3,3	3,6	3,8
62	—	—	—	—	—	—	3,7	3,8	4,0	3,0	3,2	3,5
64	—	—	—	—	—	—	3,4	3,5	3,6	2,7	2,9	3,1
66	—	—	—	—	—	—	3,1	3,2	—	2,4	2,6	2,8
68	—	—	—	—	—	—	2,8	2,9	—	2,0	2,3	2,5
70	—	—	—	—	—	—	2,6	—	—	—	2,0	2,2
72	—	—	—	—	—	—	2,3	—	—	—	—	—

For complete chart, refer to www.cranelibrary.com.

THIS CHART IS ONLY A GUIDE AND SHOULD NOT BE USED TO OPERATE THE CRANE.

The individual crane's load chart, operating instructions and other instructional plates must be read and understood prior to operating the crane

Luffing jib range diagram

No. 135 luffing jib on No. 74A boom

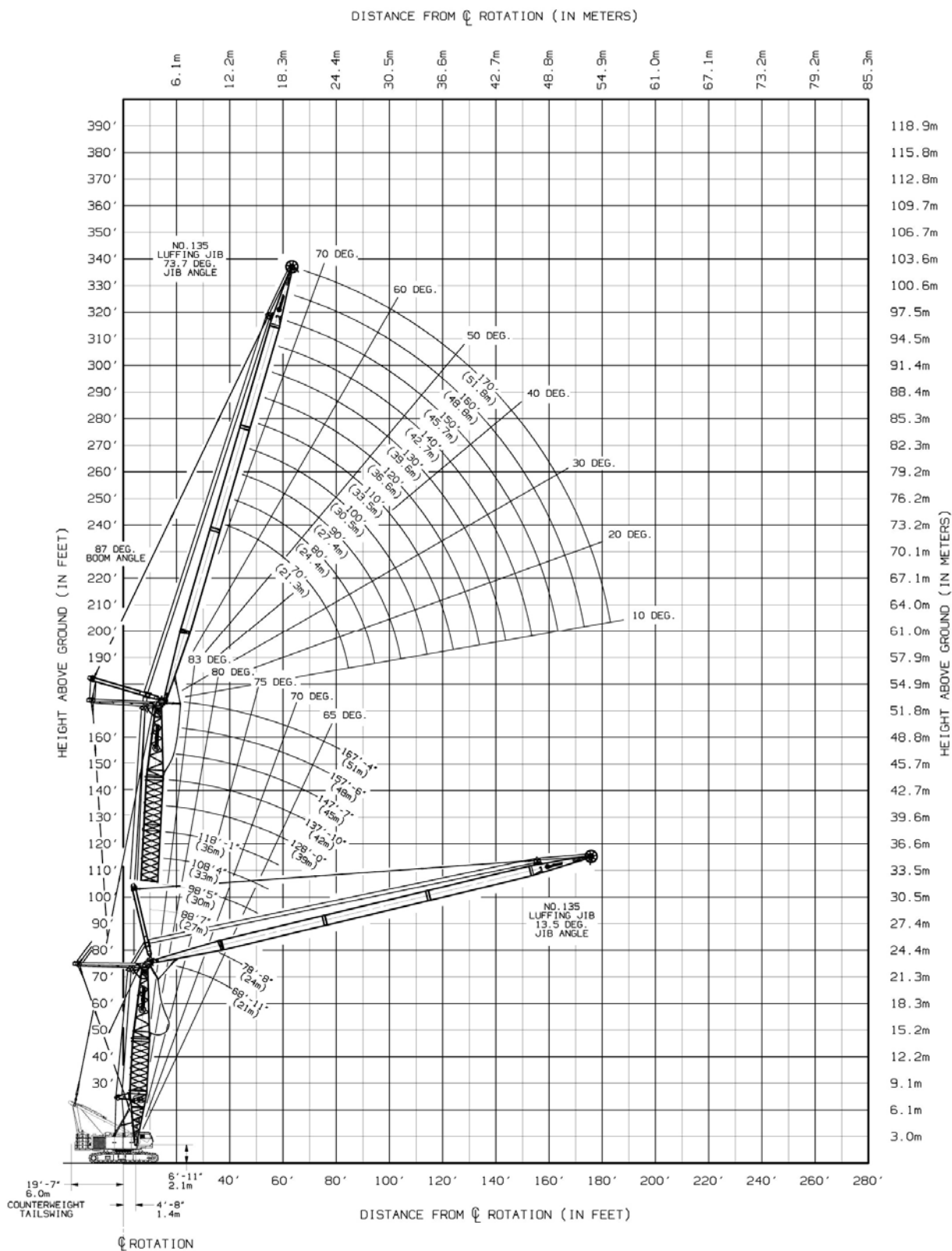

Luffing jib load charts

No. 135 luffing jib on No. 74A boom

56 000 kg upper counterweight
20 450 kg carbody counterweight

360° Rating

kg x 1000

87° boom angle

21,3 m luffing jib length

Radius m	Boom length m			
	21	30	39	51
9,1	50,0	—	—	—
10	50,0	46,3	40,9	—
12	47,0	45,8	40,7	32,7
14	41,8	39,6	36,8	30,2
16	37,2	34,8	32,6	27,7
18	32,8	31,2	29,4	25,2
20	28,8	28,3	26,9	22,9
22	25,6	25,6	24,9	20,9
24	21,4	22,8	22,8	19,2

30,5 m luffing jib length

Radius m	Boom length m			
	21	30	39	51
12	37,0	34,9	—	—
14	34,7	34,3	31,2	24,3
16	32,7	32,3	30,5	22,9
18	30,8	30,6	28,3	21,4
20	28,7	28,1	25,9	19,9
22	25,4	25,4	23,7	18,4
24	22,7	22,7	21,6	17,0
26	20,6	20,5	19,6	15,6
28	18,7	18,7	17,9	14,4
30	17,1	17,1	16,3	13,3
32	15,7	15,7	14,9	12,4
34	—	—	—	11,6

39,6 m luffing jib length

Radius m	Boom length m			
	21	30	39	51
14	23,5	—	—	—
16	22,9	21,8	20,6	17,8
18	22,3	21,3	20,1	17,0
20	21,7	20,8	19,7	16,2
22	21,0	20,4	19,3	15,3
24	19,9	19,8	18,4	14,5
26	18,9	18,9	17,2	13,6
28	18,0	18,0	16,0	12,7
30	16,9	16,9	14,9	11,9
32	15,6	15,6	13,8	11,1
34	14,4	14,4	12,8	10,4
36	13,4	13,3	11,9	9,7
38	12,5	12,4	11,0	9,1
40	11,6	11,6	10,3	8,6
42	10,0	10,8	9,6	8,1
44	—	—	—	7,8

51,8 m luffing jib length

Radius m	Boom length m			
	21	30	39	51
18	16,7	—	—	—
20	15,8	15,6	14,4	11,8
22	14,9	14,8	13,9	11,4
24	14,0	14,0	13,5	11,1
26	13,2	13,2	13,0	10,6
28	12,4	12,4	12,4	10,2
30	11,6	11,7	11,7	9,8
32	10,9	11,0	11,0	9,4
34	10,2	10,3	10,4	8,9
36	9,5	9,7	9,7	8,5
38	8,9	9,0	9,2	8,1
40	8,3	8,5	8,6	7,6
42	7,8	7,9	8,0	7,3
44	7,3	7,4	7,6	6,9
46	6,8	6,9	7,0	6,5
48	6,2	6,4	6,5	6,2
50	5,7	5,8	6,0	5,8
52	5,2	5,3	5,4	5,3
54	4,7	4,8	5,0	4,8
56	—	—	—	4,4

Upperworks

Engine

Cummins Model QSL9-325 Tier 3, 6 cylinder, 242 kw at 2100 governed rpm.

Cummins Model QSL9-310 Tier 4 Final, 6 cylinder, 230 kw at 2100 governed rpm.

Includes engine block heater (120 V), air heater starting aid (24 V), oil heater starting aid (120 V), high silencing muffler (Tier 3) or aftertreatment system (Tier 4 Final), radiator and fan. 24 volt starting and 110 amp alternator.

One 617 liter capacity diesel fuel tank, mounted on right side of upperworks with sight and electrical level indicator.

Controls

Hydraulic pilot controls provide infinite speed response directly proportional to control lever movement. Controls include Manitowoc's CAN-BUS operating system providing microprocessor driven control logic, pump control, on-board diagnostics and service information.

Block-up limit control is standard for hoist and whip lines. RCL/RCI (rated capacity limiter/rated capacity indicator) system is standard for main boom and upper boom point. "Function cut-out" or "warning only" operation is available via programmable configuration.

Travel and swing alarms are standard.

Hydraulic system

Three high-pressure pumps are driven by the engine. Two pumps provide hydraulic power enabling simultaneous multi-function capability. One pump provides independent "closed loop" hydraulic power for the swing system. An additional fourth pump is required for free fall.

Hydraulic reservoir capacity is 598 liter and is equipped with breather, sight and electrical level indicator, clean out access, and internal diffuser.

Each function is equipped with relief valves to protect the hydraulic circuit from overload or shock.

Replaceable, 10 micron (absolute) full flow tank filter is furnished in the hydraulic circuit. All oil is filtered prior to return to the hydraulic reservoir.

Hydraulic system also includes hydraulic oil cooler.

Drums

Two equal width winches are driven by independent variable displacement axial piston hydraulic motors through planetary reduction. Drums are grooved for 26 mm rope.

Powered hoisting/lowering operation is standard with automatic (spring applied, hydraulically released) multi-disc brakes, and drum rotation indicators.

- Optional: free-fall operation for front and/or rear drums.
- Optional: auxiliary (third) hydraulic powered drum mounted in boom butt. Includes third drum control system. Auxiliary drum may be used as the luffing hoist when machine is equipped with a luffing jib.
- Optional: auxiliary drum preparation includes electric wiring, controls, hydraulic selector valve and plumbing.

Boom hoist

Independent boom hoist consists of a single drum grooved for 22 mm diameter wire rope. Includes 22 mm diameter wire rope for 18 part line reeving.

Drum is powered by a fixed displacement hydraulic motor coupled to an internal brake and planetary gearbox equipped with ratchet and pawl.

Mast

Moving mast is 7,2 m long and connects the boom hoist reeving to the steel boom strap rigging. When used with optional self-erect package, the mast is utilized for crane assembly and disassembly. The mast is capable of lifting and positioning the crawler assemblies, stacking the counterweights and assembling the boom and jib, utilizing the self assembly cylinder.

Rotating bed includes counterweight raising cylinders capable of lifting the entire upperworks counterweight for removal and installation. The upperworks counterweight is attached to rotating bed with power-actuated pins.

Counterweight

Counterweight raising cylinders are mounted in the rotating bed with chain connecting the top of the cylinders and the counterweight tray. The upper counterweight is secured to the rotating bed with hydraulically actuated pins.

Upper counterweight consists of a one-piece tray and eight upper counterweight boxes. Series 2 carbody counterweight boxes are attached to carbody (each side) and weigh 10 225 kg

Series 1
Upper counterweight (6 pieces+tray)

46 000 kg

Series 2

Upper counterweight (8 pieces+tray)

56 000 kg

Carbody counterweight (2 pieces)

20 450 kg

Total counterweight

76 450 kg

Swing system

Independent single swing drive mounted in rotating bed is powered by a hydraulic piston type motor driving a spur gear through a planetary reduction.

Maximum swing speed: 2.5 rpm.

Operator's cab

Fully enclosed and galvaneeled steel insulated module is equipped with sliding door, large safety glass windows on all sides and roof. Signal horn, cab space heater, front and roof windshield wipers, air conditioning, dome light, sun visor and shade, fire extinguisher and air circulating fan are standard.

- Additional optional: External RCI light.

Specifications

Lowerworks



Carbody

High-strength fabricated steel assembly utilizing Manitowoc's FACT™ connection system incorporating two hydraulically powered pins for fast installation and removal of crawlers.



Crawlers

Crawler assemblies are 8 m long high-strength steel fabrications with 1,1 m wide cast steel crawler pads. Each crawler is powered independently by a variable displacement hydraulic motor driving a planetary reduction. Crawlers provide ample tractive effort that allows counter rotation with full rated load. Maximum ground speed of 3,1 kph.

Attachments



No. 74A boom

The liftcrane is equipped with a 15 m basic No. 74A tubular chord boom consisting of a 6 m butt and 9 m top with six 60 cm diameter roller bearing sheaves. No. 74A boom utilizes steel straps. Hydraulically powered boom hinge pin system consists of cylinder, piping, operating controls and locking device. Spring-cushioned boom stop and electronic automatic boom stop standard.

Aux drum preparation included as standard.

- No. 74A boom length is increased using 3 m, 6 m and 12 m boom inserts with steel suspension straps. Max boom length is 84 m.
- 13,6 t swivel hook and weight ball standard.



No. 134 fixed jib

9,1 m basic No. 134 tubular chord fixed jib consisting of 4,6 m jib butt and 4,6 m jib top with 3,8 m jib strut, wire rope, pendants and backstay. Includes RCL/RCI hardware.

No. 134 fixed jib length is increased using 3,05 m and 6,1 m inserts with wire rope pendants. Max fixed jib length is 24,4 m.



No. 135 luffing jib

21,3 m basic No. 135 tubular chord luffing jib assembly consisting of 8,2 m butt, 6,1 m insert, and 7 m top with two 60 cm straight roller bearing sheaves. Also included are RCL/RCI hardware, pin connected jib sections, pendants, fixed strut, jib strut, backstay pendants, boom point wheel and 26 mm luffing jib hoist line.

No. 135 luffing jib is lengthened using 3,05 m, 6,1 m, 12,2 m inserts with wire rope pendants. Maximum luffing jib length is 51,8 m.

Optional equipment

Mirrors for viewing drum operation and surroundings from operator's cab.

- Camera system includes drum cameras and monitor.
- Handrails and ladder to allow easy access to machinery from top of enclosures.
- Self-erect system includes carbody jacking cylinders with pads, controls, self assembly cylinder, boom-butt installation support, counterweight cylinders and crawler handling chain.

Detachable upper boom point with one 76 cm diameter tapered roller bearing sheave for No. 74A boom top (this is same upper boom point used on 555, 777, 999, 2250, 16000 and 18000).

Blocks and hooks:

- 60 t hook block with two 76 cm sheaves for 26 mm wire rope with swivel hook, hook latch and swivel lock.
- 100 t hook block with three 76 cm sheaves for 26 mm wire rope with swivel hook, hook latch and swivel lock.
- 200 t hook block with seven 76 cm sheaves for 26 mm wire rope with duplex swivel hook, hook latch and swivel lock.

Hydraulic Test Kit recommended to properly analyze the performance of the hydraulic system.

Service Interval Kits include the items necessary to perform general scheduled maintenance.

Special paint color (other than Manitowoc standard red and black).

Zinc rich primer (marine applications) for corrosion resistance.

Special Customer Decals: custom vinyl decal(s) of name and/or logo from artwork supplied by customer.

Export packaging: basic crane, boom and jib sections.

Symbols glossary



Boom hoist



Carbody



Controls



Counterweight



Crawlers



Drums



Engine



Hydraulic system



Mast



No. 74A boom



No. 134 fixed jib



No. 135 luffing jib



Operator's cab



Swing system

Notes

Manitowoc Cranes

Regional headquarters

Americas

Manitowoc, Wisconsin, USA

Tel: +1 920 684 6621

Fax: +1 920 683 6277

Shady Grove, Pennsylvania,

USA

Tel: +1 717 597 8121

Fax: +1 717 597 4062

Europe, Middle East, Africa

Dardilly, France

Tel: +33 (0)4 72 18 20 20

Fax: +33 (0)4 72 18 20 00

China

Shanghai, China

Tel: +86 21 6457 0066

Fax: +86 21 6457

4955

Greater Asia- Pacific

Singapore

Tel: +65 6264 1188

Fax: +65 6862 4040



Manitowoc Crane Care when you need it.

The assurance of the world's most advanced crane service and support to get you back to work fast.



Manitowoc Finance helps you get right to work generating profits for your business.

Financial tools that help you capitalize on opportunity with solutions that fit your needs.

This document is non-contractual. Constant improvement and engineering progress make it necessary that we reserve the right to make specification, equipment, and price changes without notice. Illustrations shown may include optional equipment and accessories and may not include all standard equipment.