

Manitowoc 16000

Product Guide

ASME B30.5

Imperial



Features

- 440 USt capacity
- 18,800 ft-kips maximum load moment
- 36,405 ft-kips maximum load moment with MAX-ER®
- 315 ft No. 58 HL boom
- 346.5 ft No. 133A fixed jib on No. 58 HL boom combination
- 453 ft No. 59 luffing jib on No. 58 HL boom combination
- 500 HP engine

Features

EPIC®

Manitowoc's field-proven Electronically Processed Independent Controls (EPIC) system with CAN-BUS technology delivers high productivity and precise load control by instantly matching a crane's commands to the crane function. EPIC maximizes a Manitowoc crane's function capability and simplifies servicing by pinpointing any problem in the crane's engine, power transmission and other operating systems. In addition, EPIC increases versatility by easily tailoring a Manitowoc crane's operation for specialized applications, with or without attachments.



FACT™ Connectors

Manitowoc's Fast Aligning Connection Technology (FACT) precisely and accurately aligns crane components for safe, fast, easy assembly.



CraneSTAR

CraneSTAR is an exclusive and innovative crane asset management system that helps improve your profitability and reduce costs by remotely monitoring critical crane data. Visit www.cranestar.com for more information.

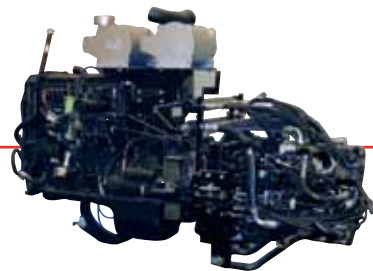

Hydraulics

Our closed-loop system provides a separate hydraulic circuit to power each crane function. The result is truly independent, variable-speed operation of the swing, load hoist, boom hoist and travel functions.

Contents

Specifications	4
Outline dimensions	7
Transport data	15
Crane assembly	16
Performance data	19
Boom combinations	24
Heavy lift boom range / load charts	27
Upper boom point range / load charts	29
Wind Attachment range / load charts	31
Fixed jib range / load charts	35
Luffing jib range / load charts	38
MAX-ER® complete information	42
Manitowoc Crane Care	56

Specifications

Upperworks



Engine

Cummins Model QSX15 – C500 Tier 4i/3b diesel, 500 BHP at 1800 RPM.

Or

Cummins QSX15-C500 Tier 3 diesel, rated 500 HP at 1800 RPM

Includes pump drive disconnect for easier starting, engine block heater (120V), ether starting aid, high silencing muffler, hydraulic oil cooler, radiator and fan.

Multiple hydraulic pump drive transmission provides power for all machine functions.

Two 12 volt, 1400 CCA at 0° F, 24 volt system and 100 amp alternator.

250 gal., with level indicator in operator's cab.

► Optional: Cold-weather package with heater for fluids, and computer display.



Controls

Modulating electronic-over-hydraulic controls provide infinite speed response directly proportional to control lever movement. Controls include Manitowoc's exclusive EPIC® Electronically Processed Independent Control system with CAN-BUS technology providing microprocessor driven control logic, pump control, on-board diagnostics, and service information.

Block-up limit control is standard for hoist and whip lines.

Integrated Rated Capacity Limiter system (RCL) is standard for main boom and upper boom point. "Function cut-out" or "warning only" operation is selected via a keyed switch on the RCL console.

Travel and swing alarms are standard.

► Optional: Anemometer (wind speed indicator). Booms and jibs are pre wired for anemometer.



Hydraulic system

High-pressure piston pumps, driven by a multi-pump transmission, provide independent closed-loop

hydraulic power for the hoisting drums, boom hoist, swing, left crawler and right crawler.

190 gal. hydraulic reservoir is equipped with breather, clean out access, and internal diffuser.

Each function is equipped with relief valves to protect the hydraulic circuit from overload or shock.

System includes oil cooler and replaceable, full flow filter. All oil is filtered before entering the hydraulic pumps.



Drums

Basic machine is equipped with 42-3/4" wide and 25-1/4" diameter main hoist drum, mounted in the boom butt, and 32-3/8" wide and 25-1/4" diameter whip drum, mounted in the rotating bed. Each drum is driven by a variable-displacement hydraulic motor through a planetary reduction system. Drums are grooved for 28 mm rope.

Powered hoisting/lowering operation is standard with automatic (spring applied, hydraulically released) multi-disc brakes, and drum rotation indicators.

► Optional: Auxiliary (third) hydraulic powered drum rated 33,000 lb line pull mounted in boom butt.



Swing system

High strength steel adapter module is mounted on 118" diameter triple row roller turntable bearing. Bearing adapter-mounted independent swing is powered by a fixed-displacement hydraulic motor coupled to an internal brake and planetary reduction.

Swing system maximum speed: 2.2 rpm.



Moving mast hoist system

Independent moving mast hoist with two grooved drums, each 12-13/16" wide and 25-1/4" diameter drum grooved for 1-1/8" diameter wire rope.

Drum is powered by variable-displacement hydraulic motors coupled to integral brake and planetary reduction gearboxes. Ratcheting pawl and rotation indicator are standard.

Raise 315' full main boom from 0° - 82° in 3 minutes, 48 seconds.

Specifications



Boom support system

Moving Mast is 32' long and connects the boom hoist reeving to the steel boom suspension strap rigging. When used with the optional self-erect package, the mast is used for crane assembly and disassembly. It is capable of lifting and positioning the crawler assemblies, stacking the counterweights, and assembling the boom and luffing jib.

Spring cushioned boom stop and automatic boom stop are standard.



Counterweight

Counterweight tray and counterweights for the upperworks attaches to the rotating bed with power actuated pins. Carbody counterweight connect to the carbody via high strength steel hooks integral with the carbody structure.

QTY.	ITEM	UNIT WEIGHT	TOTAL WEIGHT
		lb	lb
10	Upperworks Upper Side Box	18,000	180,000
1	Counterweight Tray	44,000	44,000
Series 1 Total			224,000
4	Upperworks Upper Side Box	18,000	72,000
2	Carbody Center Box	30,000	60,000
Series 2 Total			356,000
2	Upperworks Upper Side Box	18,000	36,000
4	Carbody Side Box	15,000	60,000
Series 3 Total			452,000



Vision operator's cab

The Vision Cab™ is a fully enclosed and insulated galvanized steel module mounted to the left front corner of rotating bed. Module is equipped with power tilt, sliding door, large safety glass windows, front and roof windshield wipers, dome light, sun visor and shade, fire extinguisher, air conditioning, swing and travel alarms, and radio/CD player. Operator's station swings over front of rotating bed for transportation.

► Optional: Nylon protective window covers.

Lowerworks



Carbody

Connects rotating bed to crawler assemblies. High strength fabricated steel assembly with FACT™ connection system for safe, fast installation and removal of crawler assemblies.



Crawlers

Crawler assemblies are 34' 2" long with 60" wide cast steel crawler pads and automatically lubricated intermediate rollers. Each crawler is identical and can be mounted on either side of the carbody. Each crawler is powered independently by a variable displacement hydraulic motor and includes hydraulically powered pin actuators for fast installation and removal from carbody. Carbody mounted drive motors are connected to crawler final reduction via drive shaft with guard. Crawlers provide ample tractive effort for counter rotation with full rated load.

Maximum ground speed of 0.77 mph.

Attachments



No. 58 heavy-lift boom

The liftcrane is equipped with 98' No. 58 basic boom consisting of 26' 3" butt, 39' 5" insert with luffing hoist sheaves, 16' 5" transition insert, and 16' 5" top with thirteen 30" diameter tapered roller bearing sheaves. Includes rope guides, boom hoist wire rope, boom angle indicator and hook and weight ball. The boom utilize Manitowoc's exclusive FACT™ connection system boom connector. Spring cushioned boom stop. Automatic boom stop. Powered boom hinge system including cylinder, piping, operating controls, and locking device standard.

► Optional: 19' 8" and 39' 5" No. 58 boom inserts with steel boom suspension straps.

► Optional: No. 58 detachable upper boom point with one 30" diameter tapered roller bearing steel sheave grooved for 28 mm rope with rope guard.

► Optional: 107.6 USt detachable extended upper boom point with three 30" diameter tapered roller bearing steel sheave grooved for 28 mm rope with rope guard.

Specifications



No. 133A fixed jib

70' basic No. 133A fixed jib including pin connected 30' butt, 40' top, 21' strut and mounting hardware.

Optional: 10', 20' and 40' No. 133A inserts with pin connectors.

Utilize fixed jib inserts in combination with the No. 133A fixed jib length of 140'.



No. 59 luffing jib

78' basic No. 59 luffing jib including PIN connected 23' butt, (1) 19' 8" inserts and 36' top, basic pendants, fixed strut, jib strut, backstay pendants, boom point guide wheel, luffing jib hoist with ratchet and pawl; quick disconnect for jib hoist piping, and 1" luffing jib hoist line (luffing jib preparation is standard).

Optional: 19' 8" and 39' 5" No. 59 luffing jib inserts with steel boom suspension straps.

Utilize luffing jib inserts in combination with the No. 59 basic luffing jib for total luffing jib lengths up to 275'.



The Wheeled MAX-ER®

The Wheeled MAX-ER® attachment components include:

30 m of No. 59A mast consisting of a 19.7' butt, 19.7' insert, 39.4' insert and 19.7' top.

One additional swing drive (for a total of two) mounted on the rotating module. Each swing drive is powered by a fixed-displacement hydraulic motor coupled to a planetary reduction gearbox and internal brake.

Two 39' 5" heavy No. 58 boom inserts.

Counterweight includes (8) 44,000 lb and (2) 30,000 lb boxes.

The wheeled MAX-ER® counterweight can be positioned 36.1', 42.7', or 49.2' behind the crane's centerline of rotation, utilizing structural stinger equipped with hydraulic cylinder.



The Hanging MAX-ER®

The Hanging MAX-ER® attachment components include:

30 m of No. 59A mast consisting of a 19.7' butt, 19.7' insert, 39.4' insert and 19.7' top.

One additional swing drive (for a total of two) mounted on the rotating module. Each swing drive is powered by a fixed-displacement hydraulic motor coupled to a planetary reduction gearbox and internal brake.

Two 39' 5" heavy No. 58 boom inserts.

The hanging MAX-ER® counterweight assembly attaches to the top of the mast by steel straps and to the rear of the upperworks by a beam assembly.

Counterweight includes (10) 44,000 lb and (2) 15,000 lb boxes.

The hanging MAX-ER® counterweight can be positioned 36.1', 42.7', or 49.2' behind the crane's centerline of rotation.

Optional equipment

20 USt swivel hook and weight ball. Single line pull is 30,000 lb.

Self-erect system includes, jacking cylinders with pads, 45 USt assembly block and crawler handling chains.

Hydraulic Test Kit: required to properly analyze the performance of the EPIC® control system.

Service Interval Kits for the regularly scheduled maintenance of general crane operations.

Special Paint color(s) other than Manitowoc standard red and black.

Custom vinyl decal(s) of customer name and/or logo from artwork supplied by customer.

Export Packaging: basic crane, boom and jib sections.

Additional load blocks available upon request.

Outline dimensions

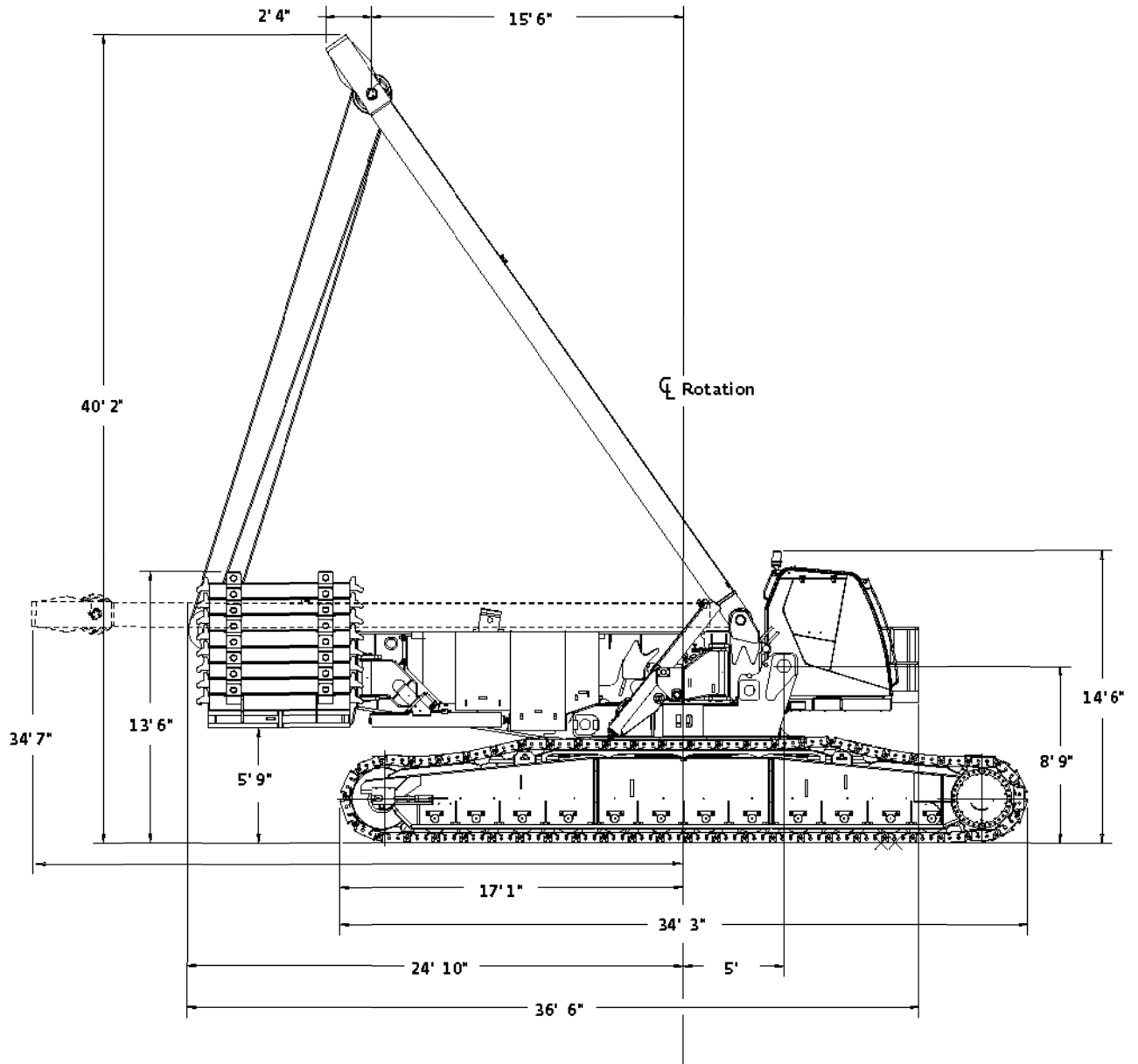

Outline dimensions

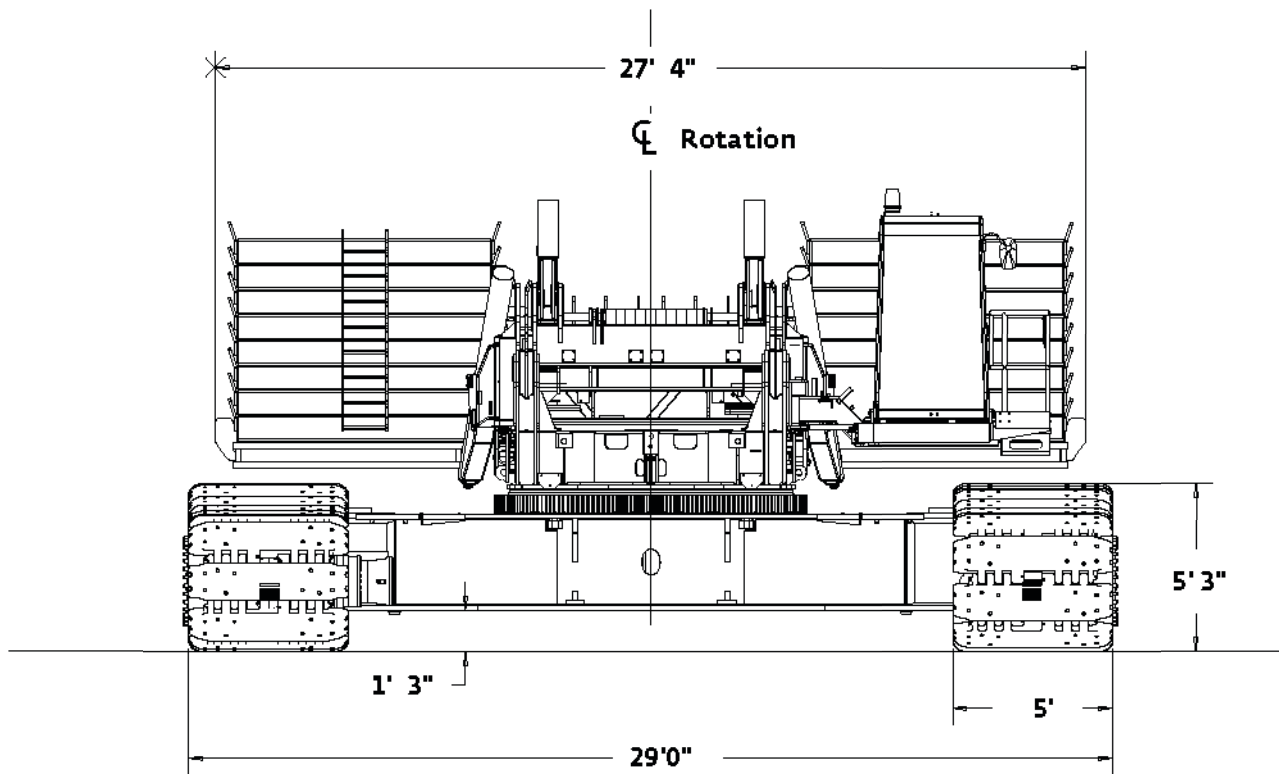

Outline dimensions

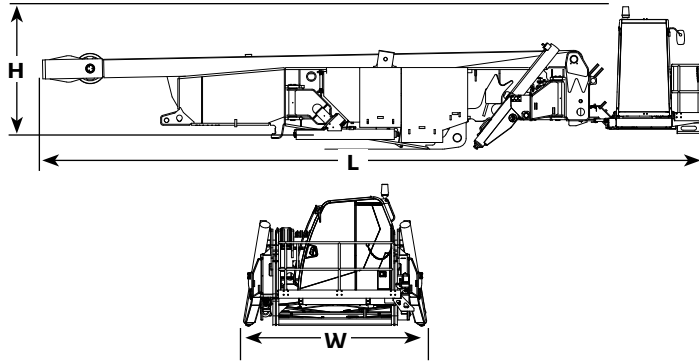

Rotating bed assembly

Length	43' 6"
Width	10' 6"
Height	9' 5"
Weight	87,330 lb

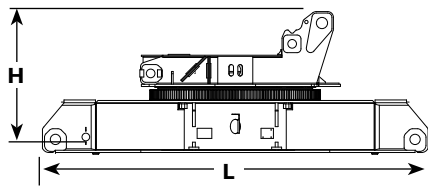

Carbody assembly

Length	22' 3"
Width	9' 10"
Height	8' 3"
Weight	62,085 lb

Note: Weight includes rotating bed adapter frame with bearing turntable, four swing drives, and carbody.

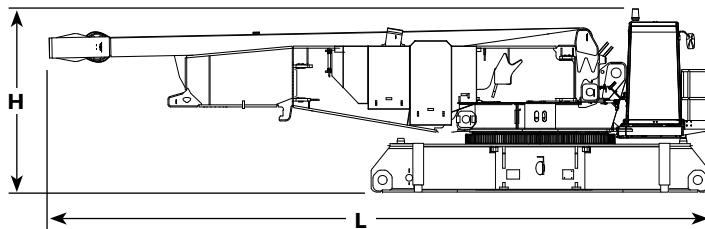

Rotating bed and carbody assembly (decked version)

Length	22' 3"
Width	9' 10"
Height	10' 6"
Weight	143,260 lb

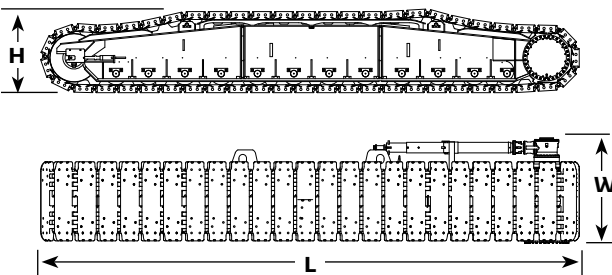

Crawlers

Length	34' 3"
Width	6' 8"
Height	5' 3"
Weight	72,015 lb

Outline dimensions

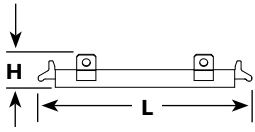

Upper counterweight

Series 1	x 10
Series 2	x 14
Series 3	x 16

Length	8' 4"
Width	8' 7"
Height	1' 4"
Weight	18,000 lb

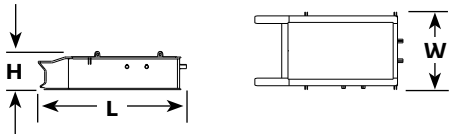

Carbody center counterweight

Series 2	x 2
Series 3	x 2

Length	11' 4"
Width	5' 11"
Height	2' 11"
Weight	30,000 lb

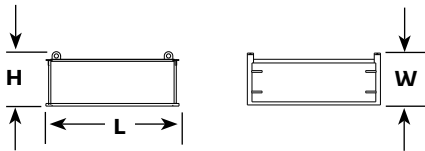

Carbody side counterweight

Series 3	x 4
----------	-----

Length	7' 2"
Width	2' 10"
Height	2' 11"
Weight	15,000 lb

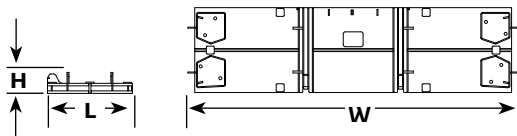

Upper counterweight tray

Length	7' 0"
Width	27' 4"
Height	1' 9"
Weight	44,000 lb

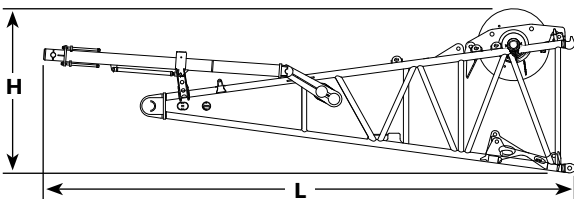

No. 58 Boom butt, drum 1, luffing drum, wire rope

Length	33' 3"
Width	9' 9"
Height	10' 2"
Weight	47,640 lb

Outline dimensions

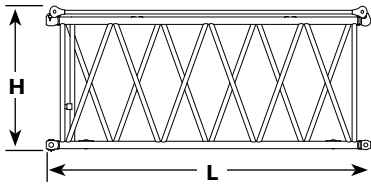

19' 8" No. 58 boom insert and straps

Length	20' 3"
Width	9' 9"
Height	8' 9"
Weight	5,650 lb

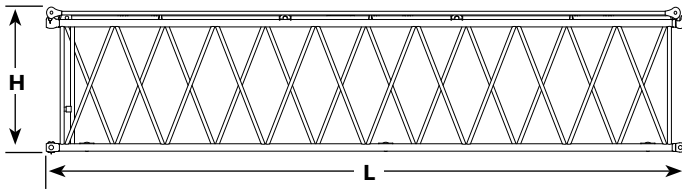

39' 5" No. 58 boom insert and straps

Length	40' 0"
Width	9' 9"
Height	8' 8"
Weight	9,340 lb

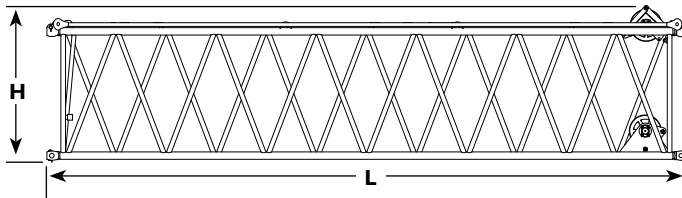

39' 5" No. 58 heavy boom insert with sheave

Length	40' 0"
Width	9' 9"
Height	8' 9"
Weight	12,335 lb

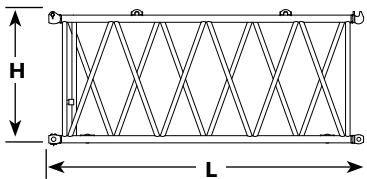

19' 8" No. 58 WA boom insert and straps

Length	20' 4"
Width	9' 9"
Height	8' 9"
Weight	5,930 lb

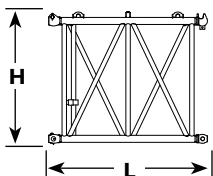

9' 10" No. 58 WA boom insert and straps

Length	10' 6"
Width	9' 9"
Height	8' 9"
Weight	3,525 lb

Outline dimensions

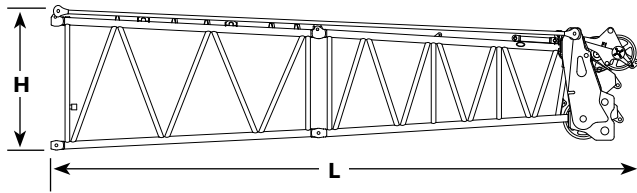

16' 5" No. 58 boom top with 16' 5" transitional insert and straps

Length	37' 5"
Width	9' 9"
Height	8' 9"
Weight	25,075 lb

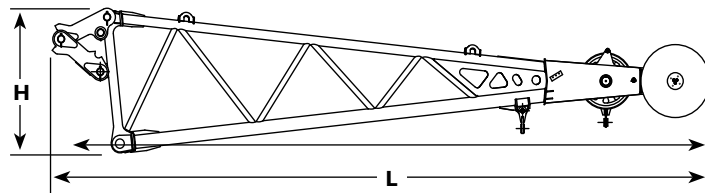

23' 0" No. 58 extended upper boom point

Length	31' 3"
Width	8' 6"
Height	6' 6"
Weight	8,100 lb

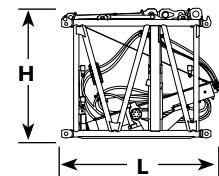

9' 8" No. 58 boom insert with BRS cylinder and straps

Length	11' 1"
Width	9' 9"
Height	9' 1"
Weight	12,000 lb

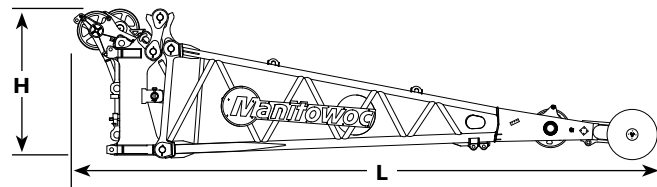

No. 58 WA boom cap and No. 58 WA extended upper boom point

Length	37' 9"
Width	8' 10"
Height	9' 9"
Weight	18,780 lb

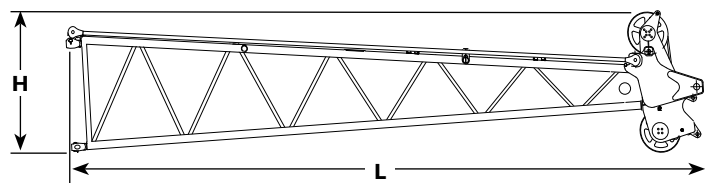

36' 1" No. 59 luffing jib top

Length	39' 2"
Width	8' 10"
Height	8' 4"
Weight	13,260 lb

Outline dimensions

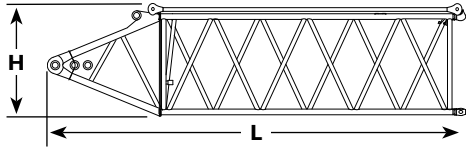

23' 0" No. 59 luffing jib butt

Length	23' 6"
Width	8' 10"
Height	7' 1"
Weight	6,000 lb

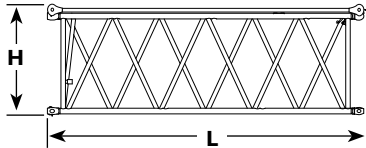

19' 8" No. 59 luffing jib insert

Length	20' 3"
Width	8' 10"
Height	7' 1"
Weight	3,715 lb

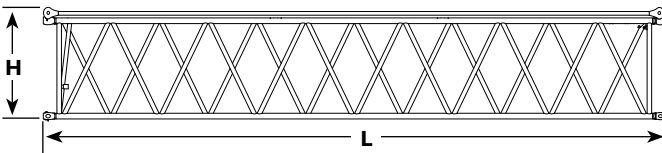

39' 5" No. 59 luffing jib insert

Length	40' 0"
Width	9' 9"
Height	7' 1"
Weight	6,455 lb

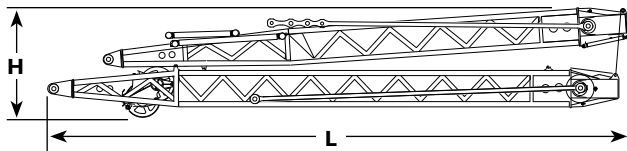

37' 9" No. 59 luffing jib strut with point sheaves and straps

Length	40' 11"
Width	8' 10"
Height	7' 5"
Weight	20,475 lb

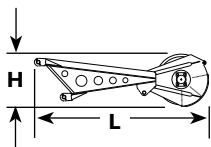

37' 9" No. 59 luffing jib upper point roller assembly

Length	8' 8"
Width	1' 4"
Height	2' 8"
Weight	1,014 lb

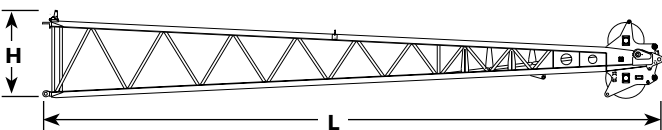

40' No. 133A fixed jib top

Length	42' 10"
Width	6' 10"
Height	5' 5"
Weight	8,045 lb

Outline dimensions

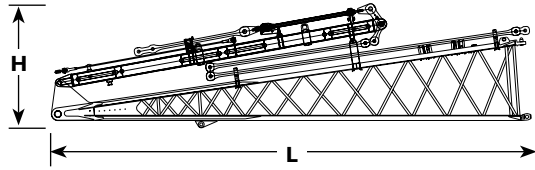

30' No. 133A fixed jib butt with struts

Length	30' 9"
Width	6' 10"
Height	7' 11"
Weight	10,157 lb

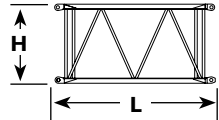

10' No. 133A fixed jib insert

Length	10' 5"
Width	6' 10"
Height	5' 5"
Weight	1,235 lb

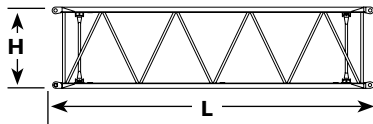

20' No. 133A fixed jib insert

Length	20' 5"
Width	6' 10"
Height	5' 5"
Weight	2,120 lb

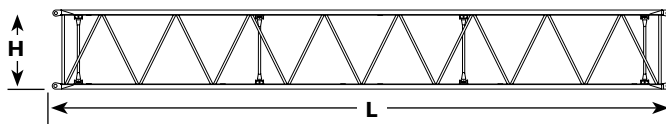

40' No. 133A fixed jib insert

Length	40' 5"
Width	6' 10"
Height	5' 5"
Weight	3,780 lb

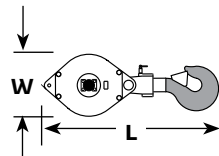

Hook block for 1-1/8" wire rope

Capacity	450 t	Length	11' 1"
Weight	21,300 lb	Width	3' 11"
Capacity	350 t	Length	8' 8"
Weight	17,400 lb	Width	3' 9"
Capacity	250 t	Length	8' 11"
Weight	11,590 lb	Width	3' 0"
Capacity	200 t	Length	8' 8"
Weight	9,500 lb	Width	2' 10"
Capacity	110 t	Length	7' 6"
Weight	7,500 lb	Width	2' 10"
Capacity	45 t*	Length	6' 3"
Weight	2,600 lb	Width	3' 0"

*Assembly block

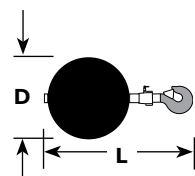

Weight ball

Capacity/Swivel	20 t	Diameter	1' 7"
Weight	1,700 lb	Length	4' 0"

Transport data

Load summary																						
Item	Weight each item lb	351 ft No. 58WA boom with BRS + 23 ft No. 58 extended upper boom point																				
		Quantity on trailer load # (Does not include blocking, strapping, etc.)																				
		1	2	3	4	5	6	7	8	9	10	11	12	13	14	15	16	17	18	19	20	21
Upperworks module	87,330	1																				
Carbody and adapter	62,085		1																			
Crawler assembly	72,015			1	1																	
Counterweight tray	44,000																	1				1
Upper counterweight (box)	18,000					1		1	1	2	1	2	1	1	2	1	2					
Carbody center counterweight	30,000																		1	1		
Carbody side counterweight	15,000							1	1										1	1		
Auxiliary counterweight tray	6,400																					1
Auxiliary counterweight (box)	17,500																				1	
26.2 ft No. 58 boom butt, drum 1 w/ wire rope	47,640						1															
16 ft 5 in No. 58 boom top and straps	20,215					1																
16 ft 5 in No. 58 boom trans. insert and straps	4,860					1																
19 ft 8 in No. 58 boom insert and straps	5,650														1							
39 ft 5 in No. 58 boom with WRG Boom insert and straps	12,335							1														
39 ft 5 in No. 58 boom insert and straps	9,340								1	1	1	1	1	1								
9.8 ft No. 58 boom insert with BRS cylinder and straps	12,000																				1	
BRS A-frame and intermediate suspension	1,500																					1
No. 58WA boom cap and No. 58 WA extended upper boom point	8,100															1						
200 USt 5 sheave load block	9,500										1											
110 USt 3 sheave load block	7,500													1								
Reel cable - 2,300 ft	8,000												1									
Miscellaneous	2,000																1					
Payload for each trailer lb		87,330	62,085	72,015	72,015	43,075	47,640	45,335	42,340	45,340	36,840	45,340	35,340	34,840	41,645	36,780	40,600	44,000	45,000	45,000	29,500	43,400

Crane assembly - undecked

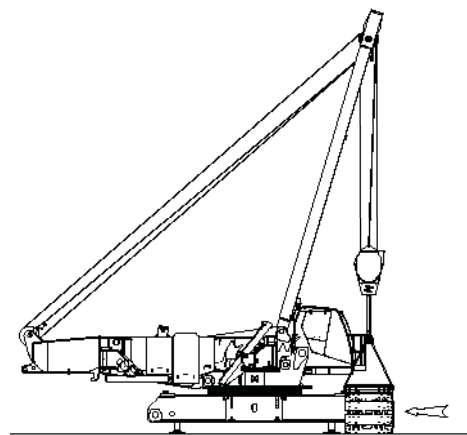
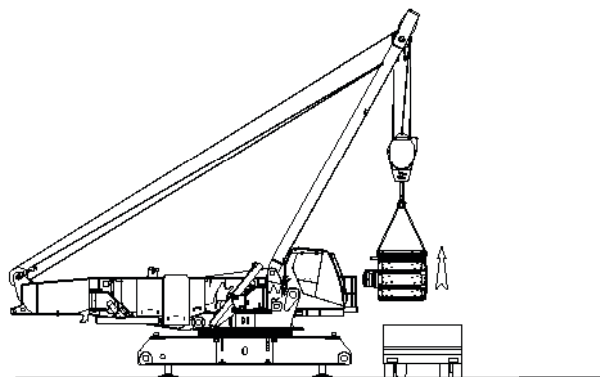
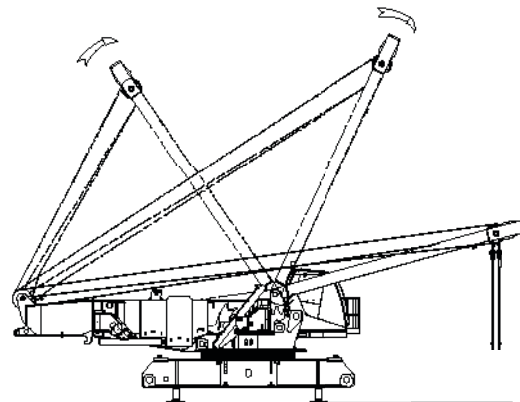
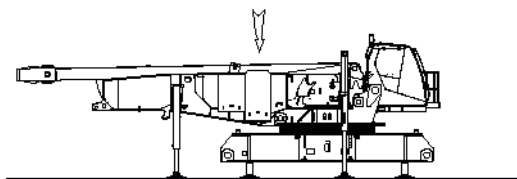
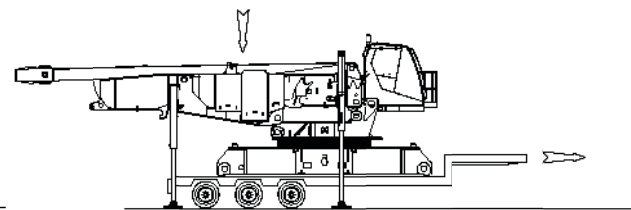
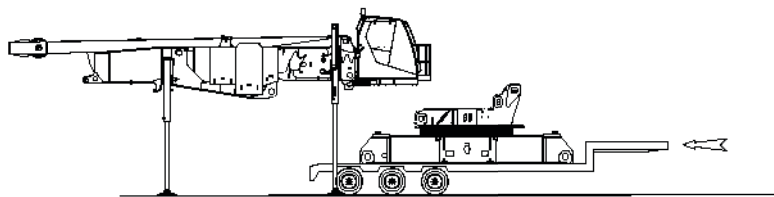
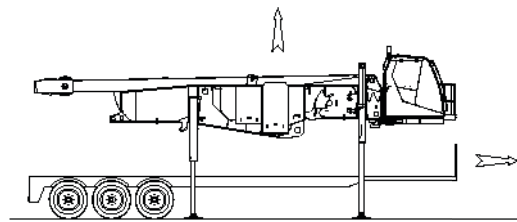
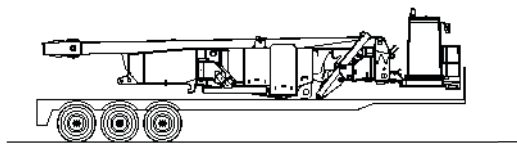

Crane assembly - undecked

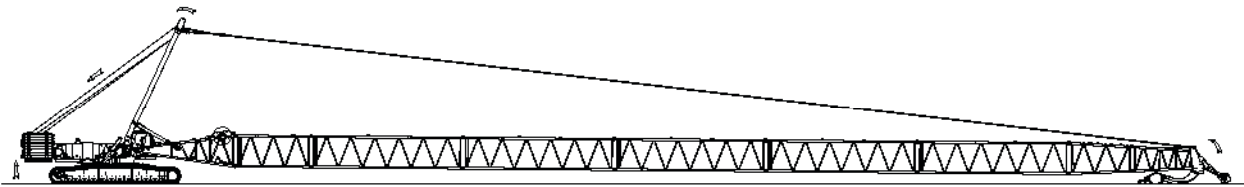
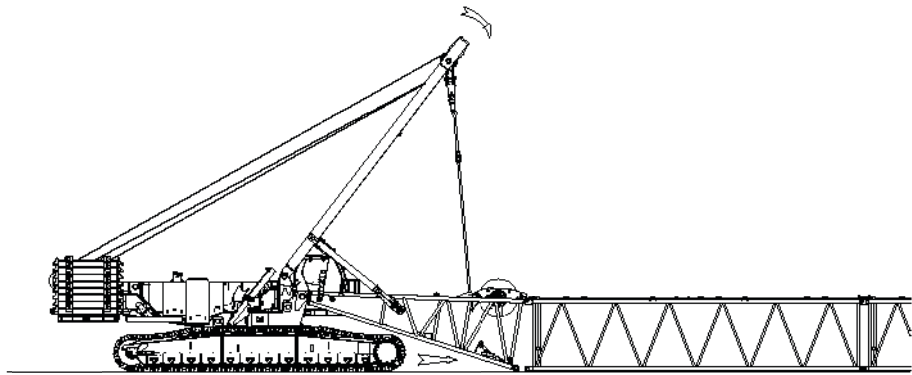
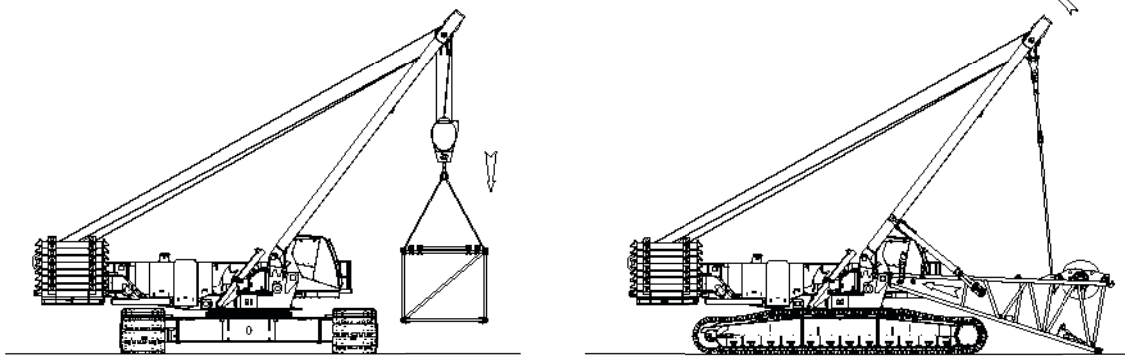
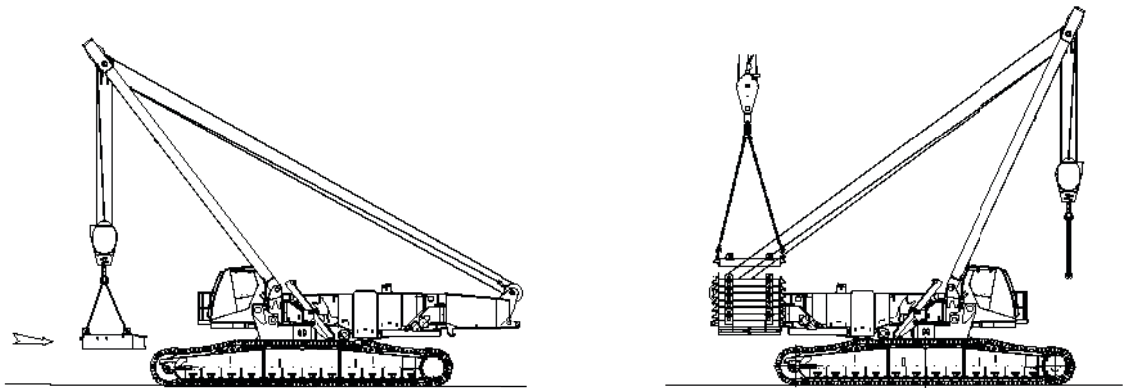

Crane assembly - decked

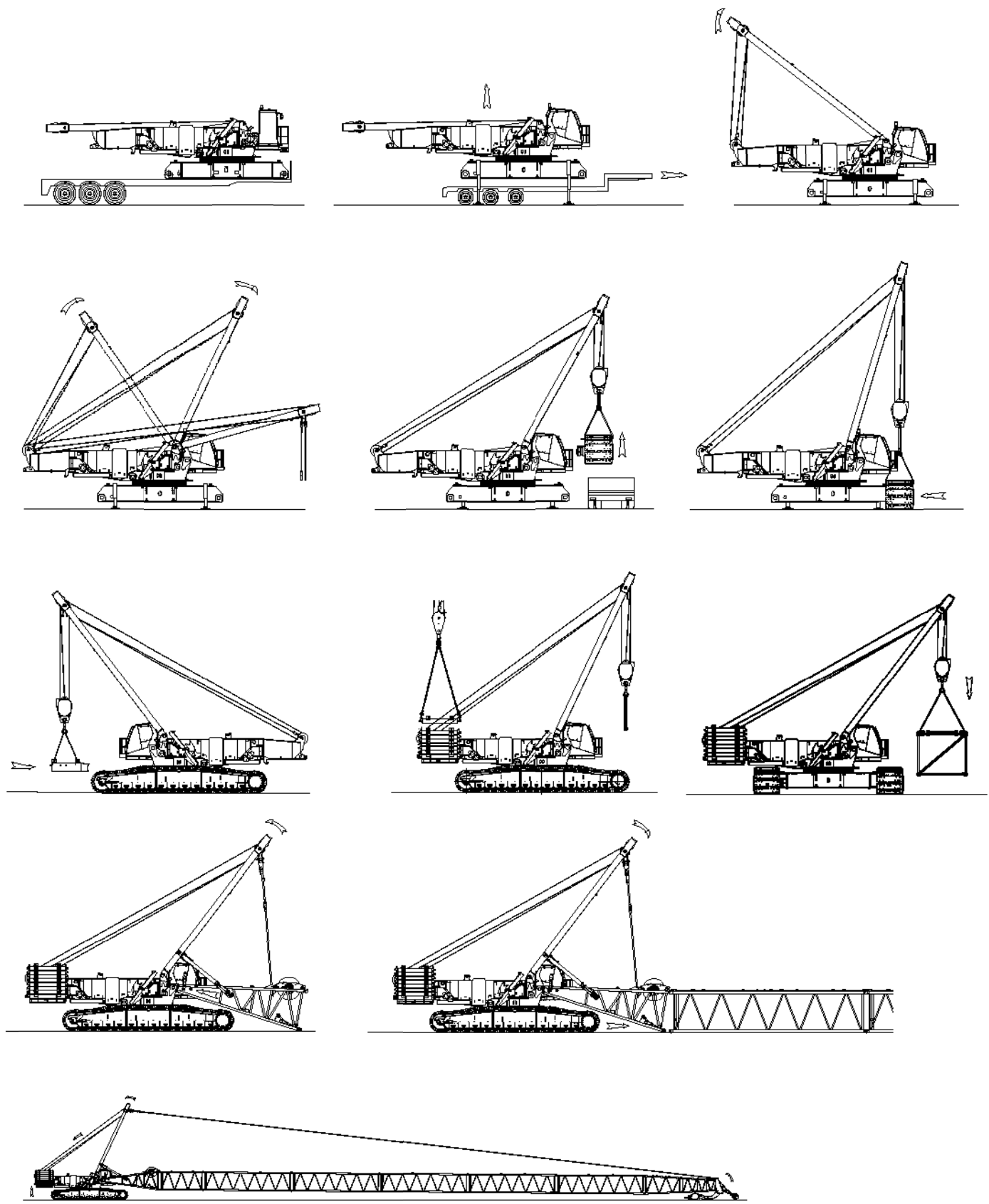

Performance data

**Main hoist
28 mm wire rope
Single line speed in ft per minute**

Single line pull lb	Layer										
	1 13.2"	2 14.3"	3 15.4"	4 16.5"	5 17.6"	6 18.7"	7 19.8"	8 20.9"	9 22.0"	10 23.1"	11 24.2"
0	345	374	403	432	460	489	518	547	576	605	634
5,000	345	374	403	432	460	489	518	547	576	605	634
10,000	345	374	403	430	456	481	506	530	554	577	601
15,000	337	361	385	408	430	442	446	450	453	457	461
20,000	322	332	336	340	344	348	352	355	359	363	367
25,000	272	276	280	284	287	291	295	299	303	307	311
30,000	234	238	242	246	250	254	257	261	265	269	273
35,800	204	208	212	215	219	223	227	231	235	239	242

**Whip drum
28 mm wire rope
Single line speed in ft per minute**

Single line pull lb	Layer						
	1 13.2"	2 14.3"	3 15.4"	4 16.5"	5 17.6"	6 18.7"	7 19.8"
0	278	301	324	347	370	394	417
5,000	262	283	303	323	343	363	382
10,000	247	265	282	299	316	330	333
15,000	222	225	228	230	233	236	239
20,000	175	178	181	183	186	189	192
25,000	147	149	152	155	158	161	164
30,000	128	131	133	136	139	142	145

Performance data

Optional high speed whip 28 mm wire rope single line speed in ft per minute							
Single line pull lb	Layer						
	1 13.2"	2 14.3"	3 15.4"	4 16.5"	5 17.6"	6 18.7"	7 19.8"
0	345	374	403	432	460	489	518
5,000	345	374	403	432	460	489	518
10,000	345	374	403	430	456	481	506
15,000	337	361	385	408	430	442	446
20,000	322	332	336	340	344	348	352
25,000	272	276	280	284	287	291	295
30,000	234	238	242	246	250	254	(257)

No. 58 HL boom 28 mm hoist line				
Boom length ft	Whip line - drum 2 or 3		Hoist line - drum 1	
	1 Part ft	2 Part ft	ft	Maximum parts of line for full hoisting range
98.4	260	380	2750	26
118.1	300	440	2800	22
137.8	340	500	2800	18
157.5	380	560	3050	18
177.2	420	610	3050	14
196.9	460	670	3050	14
216.5	500	730	3050	12
236.2	540	790	3050	10
255.9	580	850	3050	10
275.6	620	910	3050	8
295.3	660	970	3050	6
315.0	700	1030	3050	6

No. 58 HL boom Main load block reeving 28 mm wire rope	
No. parts of line	Maximum load lb
2	71,700
4	143,500
6	215,200
8	287,000
10	358,800
12	430,500
14	502,300
16	574,000
18	645,800
20	711,400
22	775,000
24	837,400
26	881,900

NOTE: Hoist and whip line lengths given in table will allow hook to touch ground. When block travel below ground is required, add additional rope equal to parts of line times added travel distance. Hoisting distance or line pull may be limited when block travel below ground is required.

Performance data

No. 58 HL boom with 23 ft extended upper boom point 28 mm wire rope			
Boom length ft	Whip line drum 2 or 3 1 Part ft	Hoist line drum 1 Total parts of line	
	ft	ft	
216.5	550	1750	6
236.2	590	1900	6
255.9	630	2000	6
275.6	670	2150	6
295.3	710	2300	6

NOTE: Hoist and whip line lengths given in table will allow hook to touch ground. When block travel below ground is required, add additional rope equal to parts of line times added travel distance. Hoisting distance or line pull may be limited when block travel below ground is required.

No. 58 HL boom with 23 ft extended upper boom point Main load block reeving 28 mm wire rope	
No. parts of line	Maximum load lb
2	71,700
4	143,500
6	215,200

No. 58 HL boom with 23 ft extended upper boom point and 98.4 ft No. 59A mast 28 mm wire rope			
Boom length ft	Whip line drum 2 or 3 1 Part ft	Hoist line drum 1 Total parts of line	
	ft	ft	
315.0	750	2450	6

NOTE: Hoist and whip line lengths given in table will allow hook to touch ground. When block travel below ground is required, add additional rope equal to parts of line times added travel distance. Hoisting distance or line pull may be limited when block travel below ground is required.

No. 58 HL boom with 23 ft extended upper boom point and No. 59A 98.4 ft mast 28 mm wire rope	
No. parts of line	Maximum load lb
2	71,700
4	143,500
6	179,800

No. 58 WA boom with 25 ft extended upper boom point 28 mm wire rope				
Boom length ft	Whip line - drum 2 or 3		Hoist line - drum 1	
	1 Part ft	2 Part ft	ft	Total parts of line
213.3	600	800	2250	8
223.1	600	850	2300	8
232.9	600	900	2400	8
242.8	650	900	2500	8
252.6	650	950	2600	8
262.5	650	950	2650	8
272.3	700	1000	2750	8
282.2	700	1050	2850	8
292.0	750	1050	2950	8
301.8	-	-	3000	8

No. 58 WA boom with 25 ft extended upper boom point Main load block reeving 28 mm wire rope	
No. parts of line	Maximum load lb
2	71,700
4	143,500
6	215,200
8	296,600

Performance data

No. 59 luffing jib on No. 58 HL boom 28 mm hoist line			
Boom length ft	Hoist line drum 1 ft	Whip line drum 2	
		1 Part ft	2 Part ft
98.4	2450	800	1200
118.1	2650	850	1250
137.8	2650	900	1300
157.5	2700	950	1400
177.2	2700	1000	1450
196.9	2700	1000	1450
216.5	2700	1000	1450

No. 59 luffing jib on No. 58 HL boom Main load block reeving 28 mm hoist line	
No. parts of line	Maximum load lb
2	71,700
4	143,500
6	215,200
8	287,000
10	358,800
12	408,500

NOTE: Hoist line lengths given in table include all luffing jib lengths. Hoist and whip line lengths given in table will allow hook to touch ground. When block travel below ground is required, add additional rope equal to parts of line times added travel distance. Hoisting distance or line pull may be limited when block travel below ground is required.

No. 133A fixed jib on No. 58 HL boom 28 mm hoist line		
ft	Hoist line drum 1 ft	Hoist line drum 2 ft
137.8	1750	1550
157.5	1850	1550
177.2	2000	1550
196.9	2150	1550
216.5	2200	1550
236.2	2300	1550

No. 133A luffing jib on No. 58 HL boom Main load block reeving 28 mm hoist line	
No. parts of line	Maximum load lb
2	71,700
4	143,500
6	205,700

NOTE: Hoist line lengths given in table include all luffing jib lengths. Hoist and whip line lengths given in table will allow hook to touch ground. When block travel below ground is required, add additional rope equal to parts of line times added travel distance. Hoisting distance or line pull may be limited when block travel below ground is required.

Performance data

MAX-ER No. 58 HL boom 28 mm wire rope				
Boom length ft	Whip line - drum 2 or 3		Hoist line - drum 1	
	1 Part ft	2 Part ft	ft	Total parts of line
137.8	350	500	3550	24
157.5	390	560	3700	22
177.2	430	620	3800	20
196.9	470	680	3800	18
216.5	510	740	3800	16
236.2	550	800	3800	14
255.9	580	860	3900	14
275.6	620	910	3900	12
295.3	660	970	3900	10
315.0	700	1030	3900	8
334.6	740	1090	3900	8
354.3	780	1150	3900	6
374.0	820	1210	3900	6
393.7	860	1270	3900	6

MAX-ER No. 58 HL boom Main load block reeving 28 mm wire rope	
No. parts of line	Maximum load lb
2	71,700
4	143,500
6	215,200
8	287,000
10	358,800
12	430,500
14	502,300
16	574,000
18	645,800
20	711,400
22	775,000
24	837,400

NOTE: Hoist and whip line lengths given in table will allow hook to touch ground. When block travel below ground is required, add additional rope equal to parts of line times added travel distance. Hoisting distance or line pull may be limited when block travel below ground is required.

Boom combinations

No. 58 HL boom combinations

Boom length ft	Boom inserts length ft			
	16.4 ^o	19.7	39.4	39.4 ^{**}
98.4	1	0	0	1
118.1	1	1	0	1
137.8	1	0	1	1
157.5	1	1	1	1
177.2	1	0	2	1
196.9	1	1	2	1
216.5	1	0	3	1
236.2	1	1	3	1
255.9	1	0	4	1
275.6	1	1	4	1
295.3	1	0	5	1
315.0	1	1	5	1

**transition boom insert.*
***with auxiliary sheave insert.*

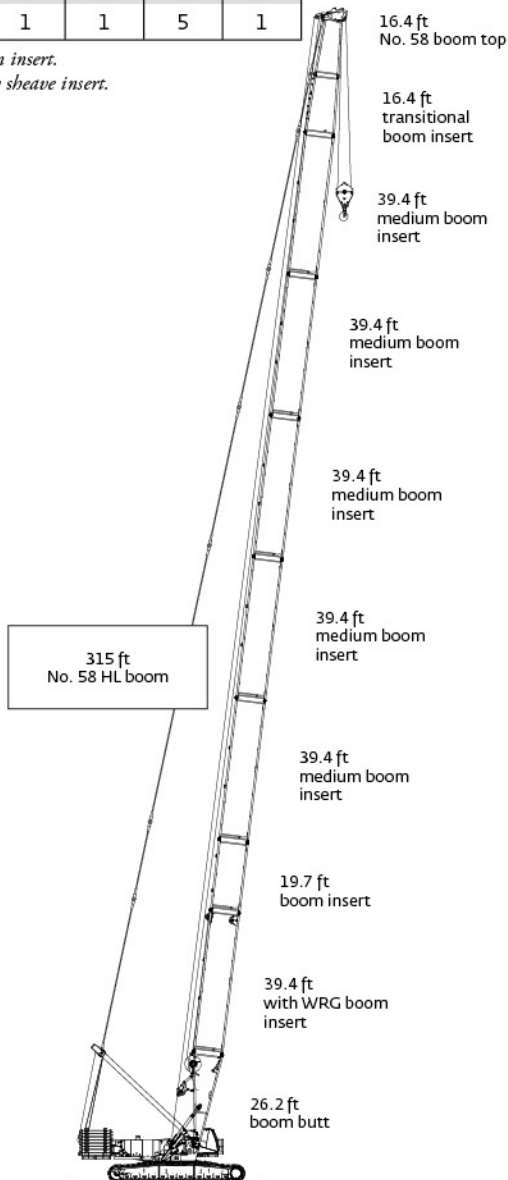

No. 58 HL boom with 23 ft extended upper boom point combinations

Boom length ft	Boom inserts length ft			
	16.4 ^o	19.7	39.4	39.4 ^{**}
98.4	1	0	0	1
118.1	1	1	0	1
137.8	1	0	1	1
157.5	1	1	1	1
177.2	1	0	2	1
196.9	1	1	2	1
216.5	1	0	3	1
236.2	1	1	3	1
255.9	1	0	4	1
275.6	1	1	4	1
295.3	1	0	5	1

**transition boom insert.*
***with auxiliary sheave insert.*

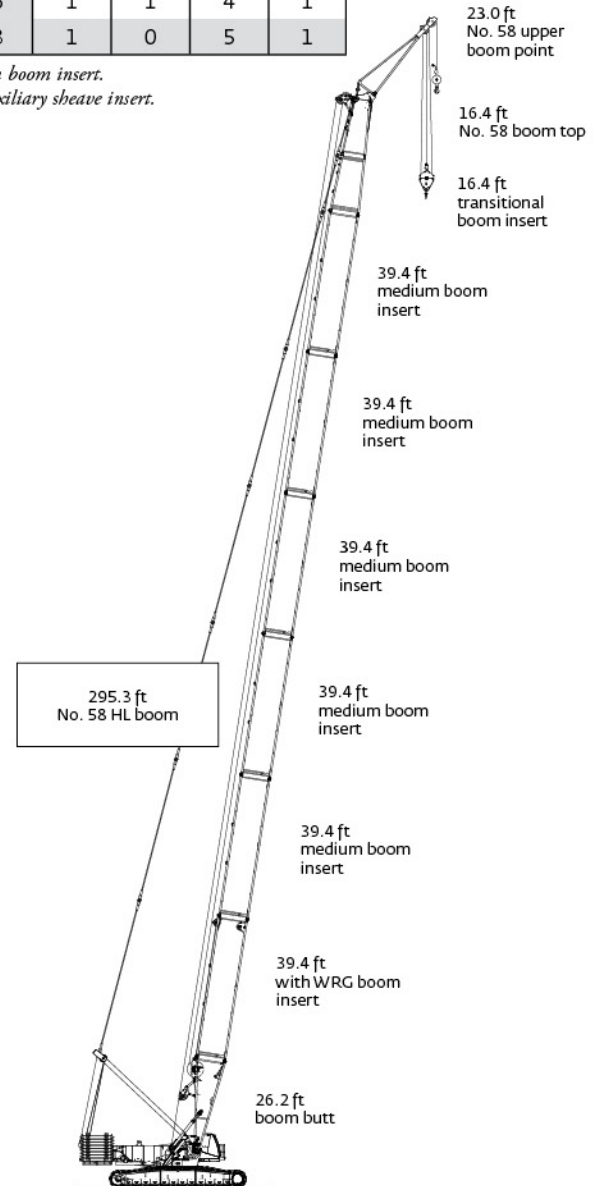

Boom combinations

No. 58 WA boom combinations with 24.9 ft extended upper boom point

Boom length ft	Boom inserts length ft				
	16.4*	19.7	39.4	39.4	39.4**
213.3	1	1	0	3	1
223.1	1	0	1	3	1
232.9	1	1	0	3	1
242.8	1	0	1	4	1
252.6	1	1	0	4	1
262.5	1	0	1	4	1
272.3	1	1	0	4	1
282.2	1	0	1	5	1
292.0	1	1	0	5	1
301.8	1	0	1	5	1

*transition boom insert.
**with auxiliary sheave insert.

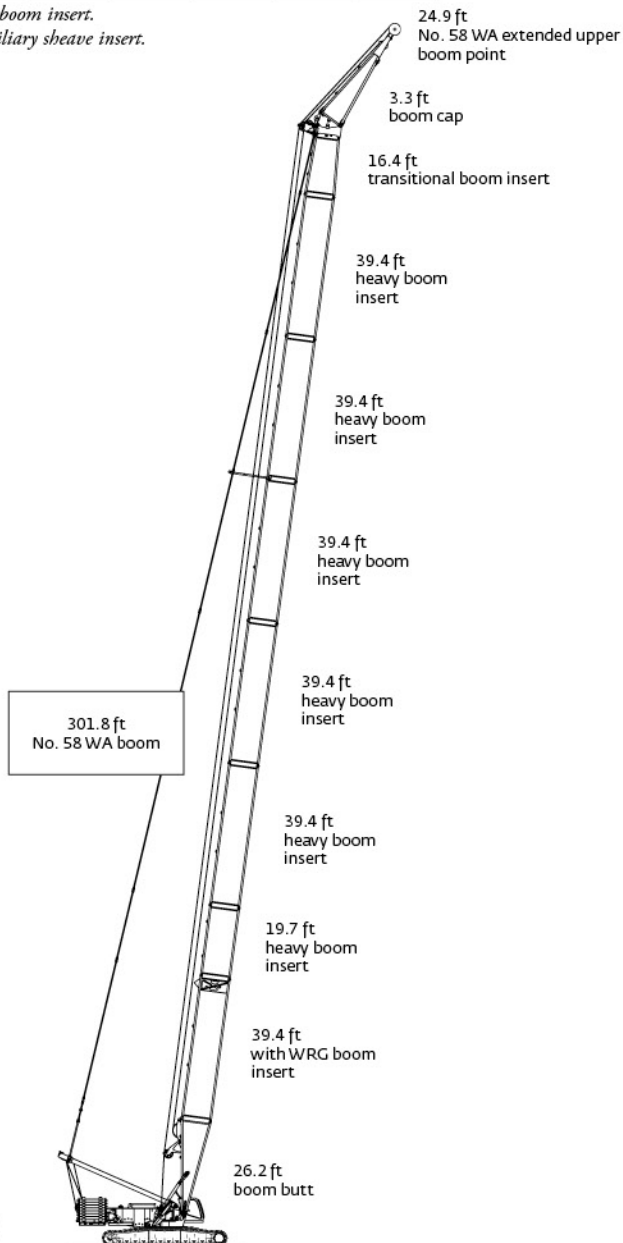

No. 58 WA boom with BRS combinations with 24.9 ft extended upper boom point

Boom length ft	Boom inserts length ft						
	16.4*	9.8	9.8***	19.7	39.4	39.4	39.4**
292	1	0	1	0	5	0	1
301.8	1	1	1	0	5	0	1
311.7	1	0	1	1	5	0	1
321.5	1	1	1	1	5	0	1
331.4	1	0	1	0	5	1	1
341.2	1	1	1	0	4	2	1
351.1	1	0	1	1	4	2	1

*transition boom insert.
**with auxiliary sheave insert.
***with BRS cylinder insert.

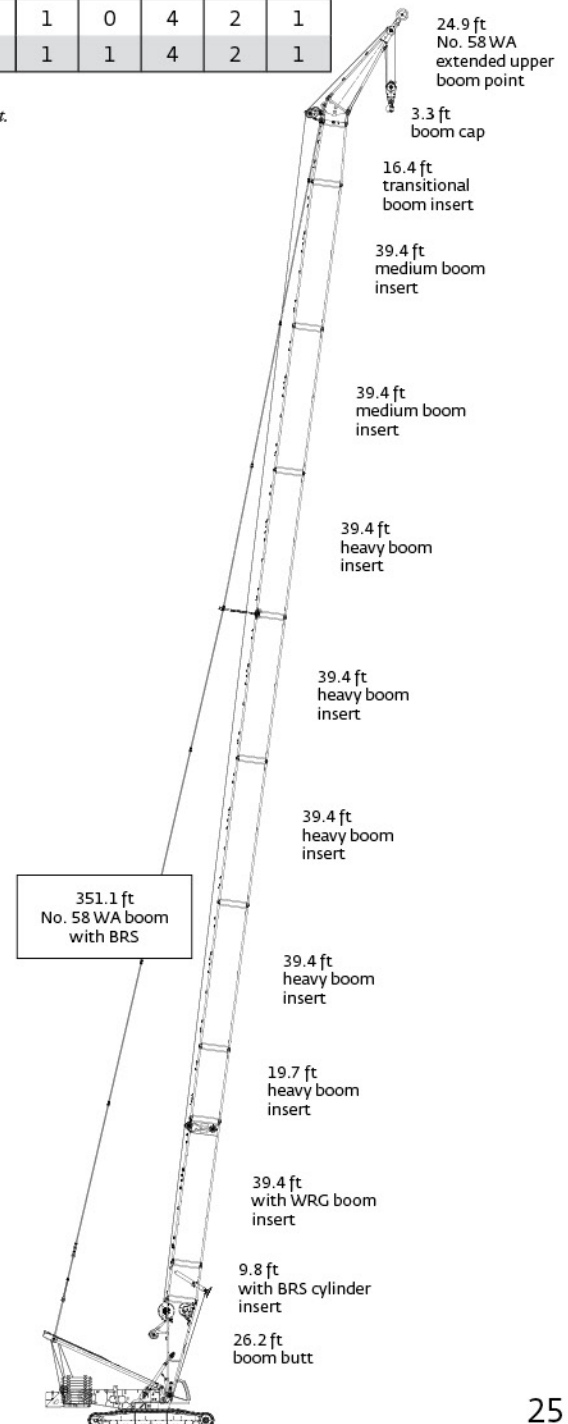

Boom combinations

No. 133A fixed jib combinations			
Fixed jib length ft	Fixed jib inserts length ft		
	10.0	20.0	40.0
70	0	0	0
80	1	0	0
90	0	1	0
100	1	1	0
110	0	0	1
120	1	0	1
130	0	1	1
140	1	1	1

No. 59 luffing jib combinations		
Luffing jib length ft	Luffing jib inserts length ft	
	19.7	39.4
78.7	1	0
98.4	0	1
118.1	1	1
118.1	0	2
157.5	1	2
177.24	0	3
196.9	1	3
216.5	0	4
236.2	1	4
255.9	0	5
275.6	1	5

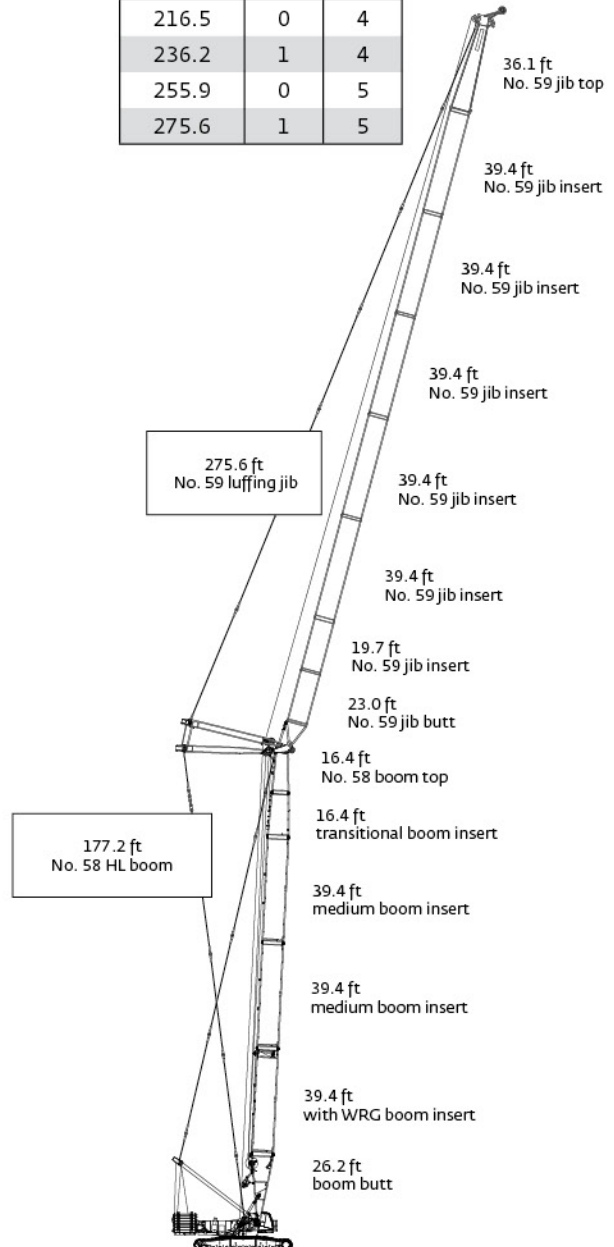
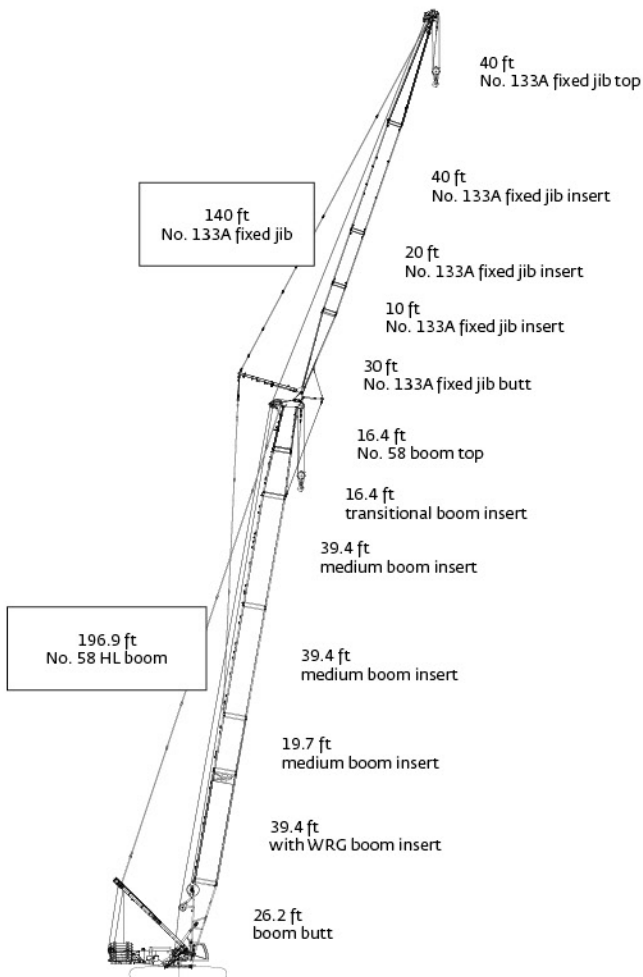

Boom range diagram

No. 58 HL boom

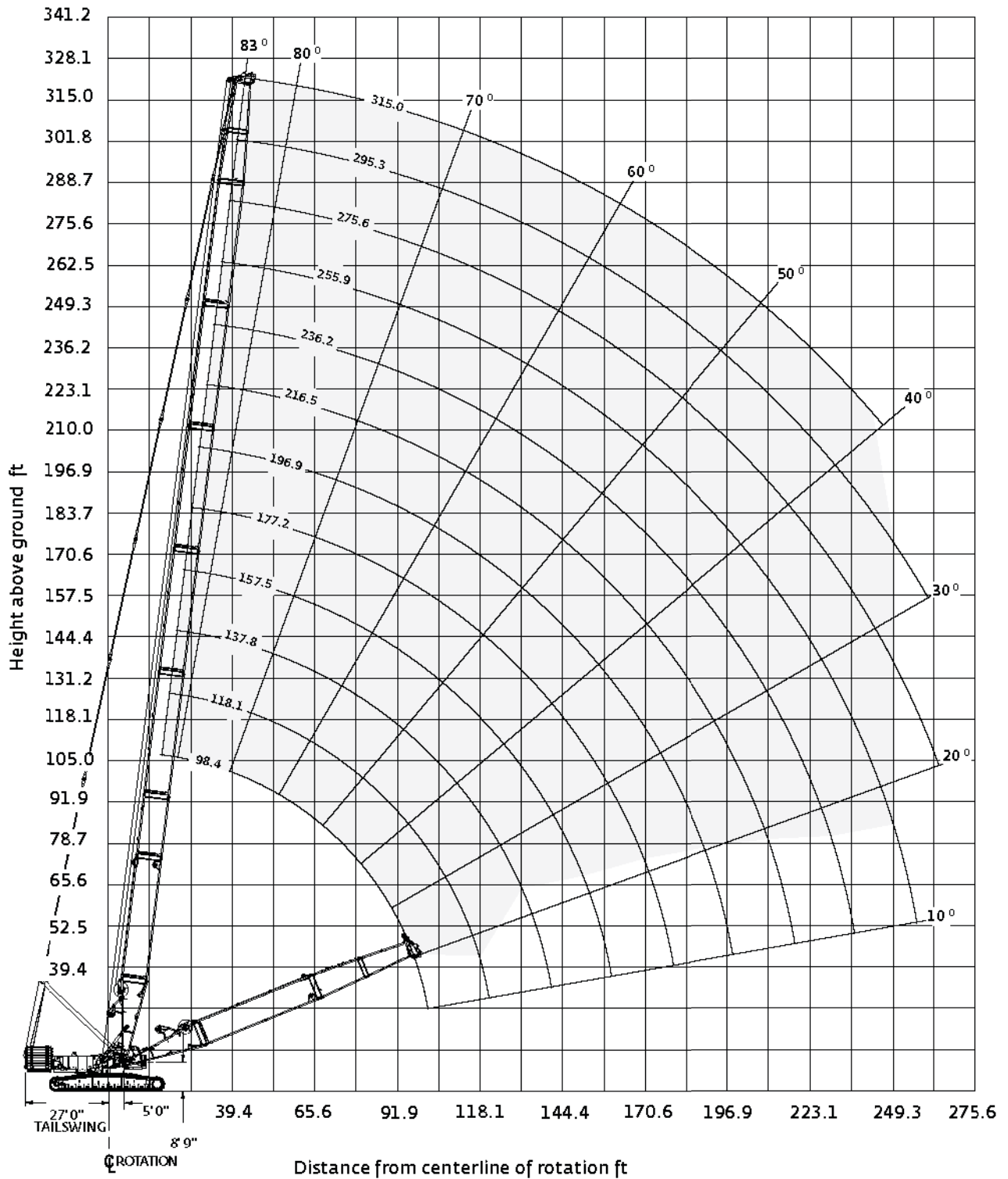

Boom load charts

360° Rating, lb x 1 000

No. 58 HL boom												
Radius ft	332,000 lb Counterweight						120,000 lb Carbody counterweight					
	Boom length ft											
	98.4	118.1	137.8	157.5	177.2	96.9	216.5	236.2	255.9	275.6	295.3	315.0
21	881.9											
26	720.5	719.3	625.7									
32	581.7	581.0	580.8	579.6	483.0							
40	419.1	419.7	420.5	420.4	420.4	397.4	348.9	321.3	302.9			
45	349.9	350.3	351.0	350.7	350.6	350.0	325.9	299.5	288.7	252.0	211.6	
60	229.3	229.5	229.9	229.3	229.0	228.1	227.5	226.4	225.6	224.5	196.3	169.5
70	183.6	183.8	184.2	183.4	183.1	182.0	181.3	180.2	179.2	178.0	176.9	161.6
85	138.5	138.7	139.1	138.3	137.8	136.7	135.9	134.6	133.5	132.2	131.0	129.6
100	108.2	108.9	109.3	108.5	108.0	106.8	106.0	104.6	103.5	102.1	100.9	99.4
110		93.9	94.5	93.7	93.2	92.0	91.1	89.8	88.6	87.1	85.9	84.4
120		81.5	82.3	81.6	81.1	79.9	79.0	77.6	76.4	74.9	73.7	72.1
130			72.1	71.5	71.1	69.8	69.0	67.5	66.3	64.8	63.6	62.0
140				62.9	62.5	61.3	(60.5	59.0	57.8	56.3	55.0	53.4
155				52.1	52.0	50.8	49.9	48.5	47.2	45.7	44.5	42.8
170					43.2	42.2	41.3	39.9	38.7	37.1	35.9	34.2
180						37.2	36.5	35.0	33.8	32.2	31.0	29.3
195						30.7	30.1	28.7	27.5	25.9	24.7	23.0
210							24.6	23.3	22.1	20.5	19.3	17.6
220								20.0	18.9	17.3	16.1	14.5
230								17.1	16.0	14.4	13.2	11.6
255										8.1	7.0	

For complete chart, refer to www.cranelibrary.com.

Extended upper boom point range diagram

No. 58 HL boom with 23 ft extended upper boom point

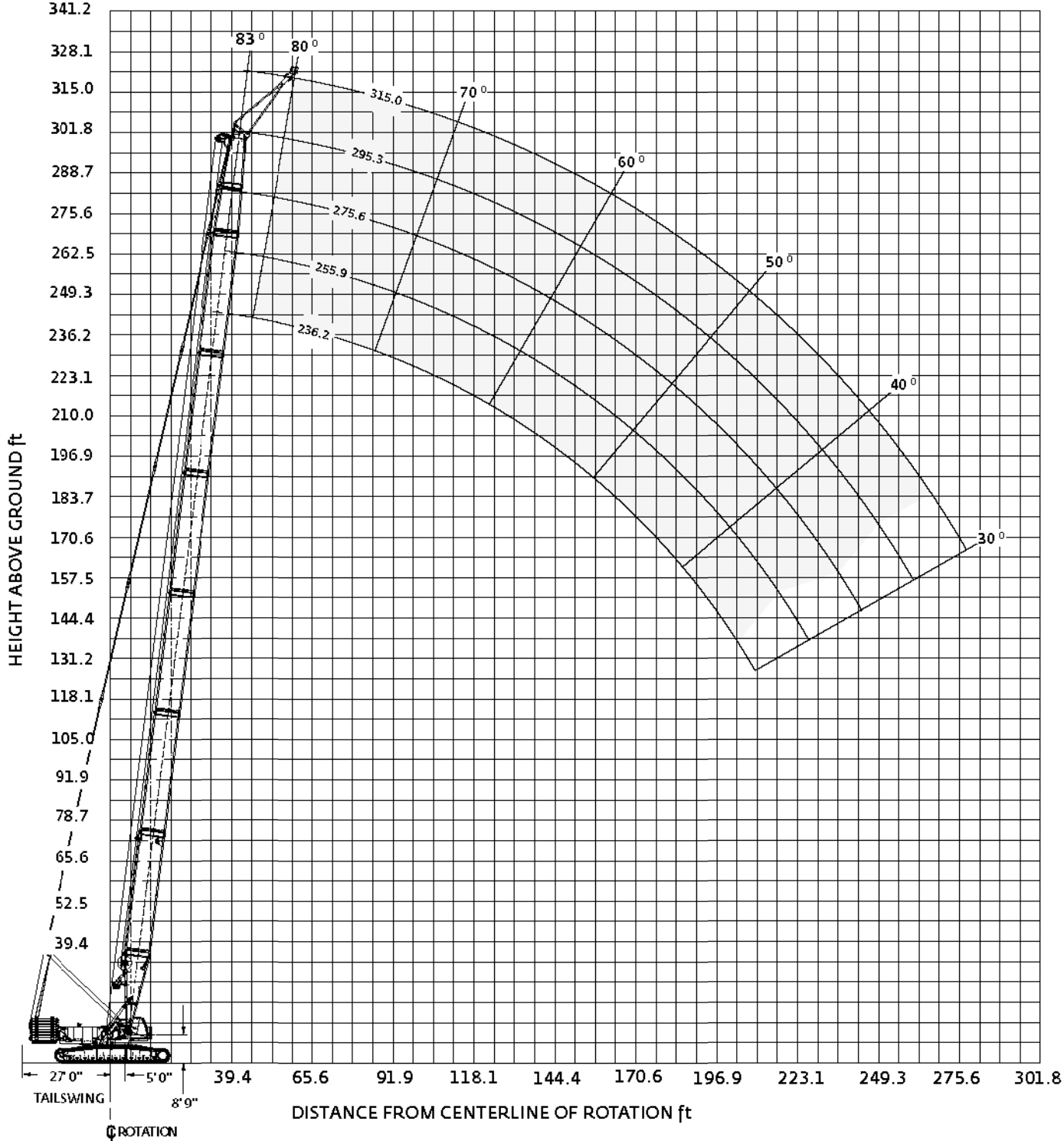

Extended upper boom point load charts

360° Rating, lb x 1 000

No. 58 HL boom with 23 ft extended upper boom point					
Radius ft	332,000 lb Counterweight 120,000 lb Carbody counterweight				
	Boom length ft				
	216.5	236.2	255.9	275.6	295.3
50	215.2				
55	215.2	215.2	201.5	193.7	
60	215.2	215.2	196.8	190.1	
65	212.3	211.5	192.6	186.6	165.0
75	172.6	171.7	170.8	169.8	158.2
80	157.2	156.1	155.2	154.2	153.2
90	132.2	131.1	130.1	128.9	127.9
95	122.0	120.8	119.8	118.6	117.5
100	112.9	111.7	110.7	109.4	108.3
105	104.9	103.6	102.5	101.3	100.2
115	91.0	89.7	88.6	87.3	86.2
125	79.6	78.3	77.2	75.8	74.6
135	70.1	68.7	67.6	66.2	65.0
145	62.0	60.6	59.4	58.0	56.8
160	51.8	50.4	49.2	47.7	46.5
175	43.5	42.1	40.8	39.4	38.2
185	38.7	37.3	36.1	34.6	33.4
200	32.4	31.1	29.8	28.4	27.1
210		27.4	26.2	24.7	23.5
225			21.3	19.8	18.7
240			17.1	15.6	14.4
250				13.0	11.9
270					7.4

For complete chart, refer to www.cranelibrary.com.

Wind Attachment range diagram

No. 58 WA with 24.9 ft extended upper boom point

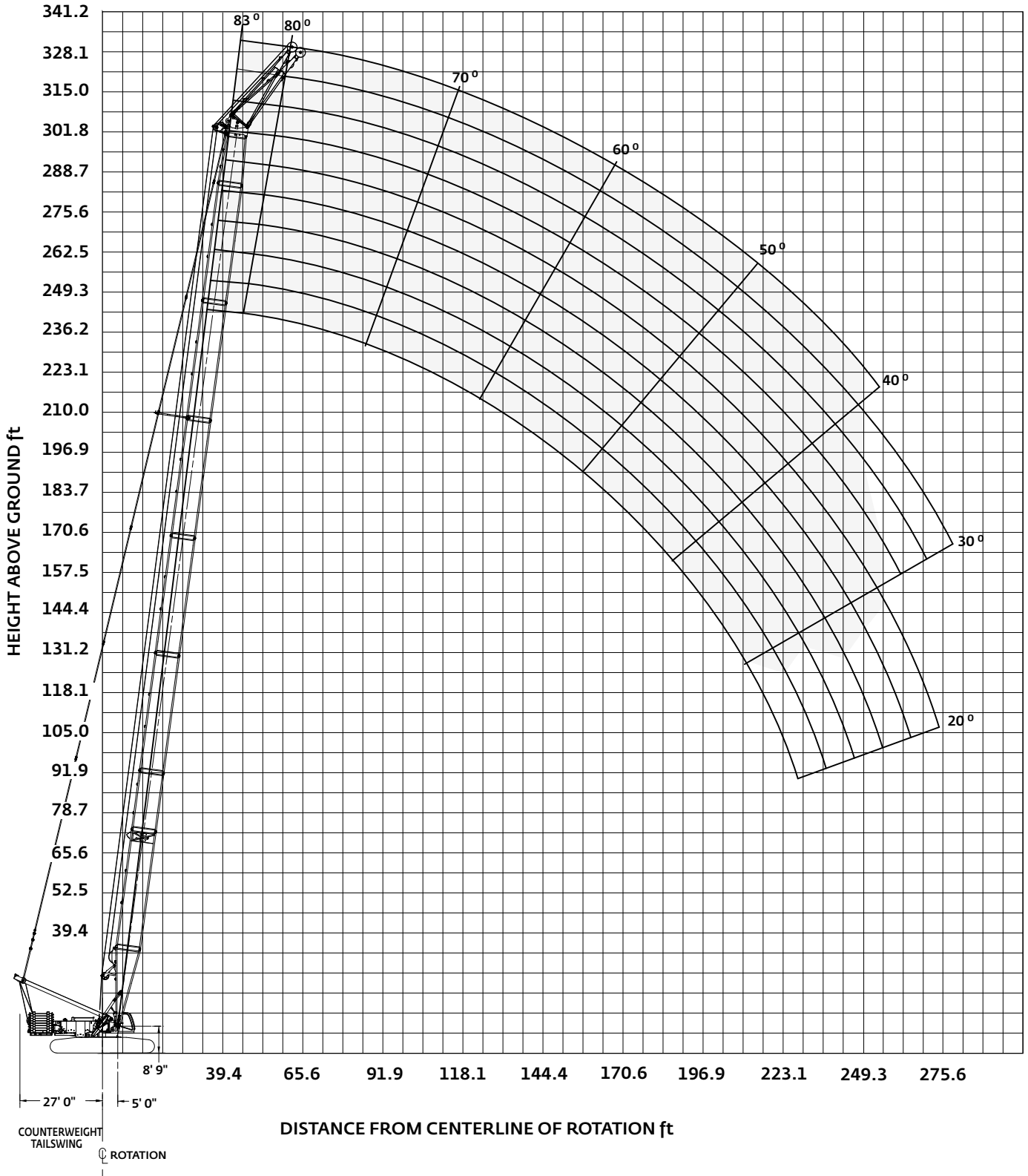

Wind Attachment load charts

360° Rating, lb x 1 000

No. 58 WA with 24.9 ft extended upper boom point													
368,000 lb Counterweight 120,000 lb Carbody counterweight													
Radius ft	28° offset Boom length ft						35° offset Boom length ft						
	213.2	232.9	252.6	272.3	292.0	301.8	Radius ft	213.2	232.9	252.6	272.3	292.0	301.8
50	286.6	286.6					50	286.6					
60	255.6	254.5	253.7	252.7	251.8	239.4	60	257.5	256.5	255.8	254.9	246.4	232.4
70	204.5	203.2	202.1	200.9	199.8	199.5	70	206.0	204.8	203.9	202.8	201.7	201.2
80	168.5	167.0	165.8	164.5	163.2	162.8	80	169.7	168.3	167.2	166.0	164.8	164.2
90	141.7	140.1	138.8	137.4	136.1	135.6	90	142.8	141.2	140.0	138.7	137.4	136.8
100	121.0	119.3	118.0	116.4	115.1	114.6	100	121.9	120.3	119.0	117.6	116.2	115.6
110	104.6	102.7	101.4	99.8	98.4	97.9	110	105.3	103.6	102.3	100.8	99.4	98.7
120	91.1	89.3	87.9	86.2	84.7	84.2	120	91.8	90.0	88.7	87.1	85.7	84.9
130	80.0	78.1	76.6	75.0	73.4	72.9	130	80.6	78.7	77.3	75.7	74.3	73.5
140	70.5	68.6	67.1	65.4	63.9	63.4	140	71.1	69.2	67.8	66.1	64.6	63.8
150	62.5	60.5	59.0	57.3	55.7	55.2	150	62.9	61.0	59.6	57.9	56.4	55.6
160	55.5	53.5	52.0	50.2	48.6	48.1	160	55.8	53.9	52.5	50.8	49.2	48.4
170	49.3	47.3	45.8	44.1	42.5	41.9	170	49.6	47.7	46.3	44.5	43.0	42.2
190	39.1	37.0	35.6	33.8	32.2	31.6	190	39.3	37.3	35.9	34.2	32.6	31.8
210	30.7	28.8	27.3	25.5	23.9	23.3	210		29.0	27.5	25.8	24.2	23.4
230		21.9	20.5	18.7	17.1	16.6	230			20.7	19.0	17.4	16.6
250			14.7	13.0	10.9	10.1	250				13.2	11.2	10.0

For complete chart, refer to www.cranelibrary.com.

Wind Attachment range diagram with Boom Raising System

No. 58 WA with BRS with 24.9 ft extended upper boom point

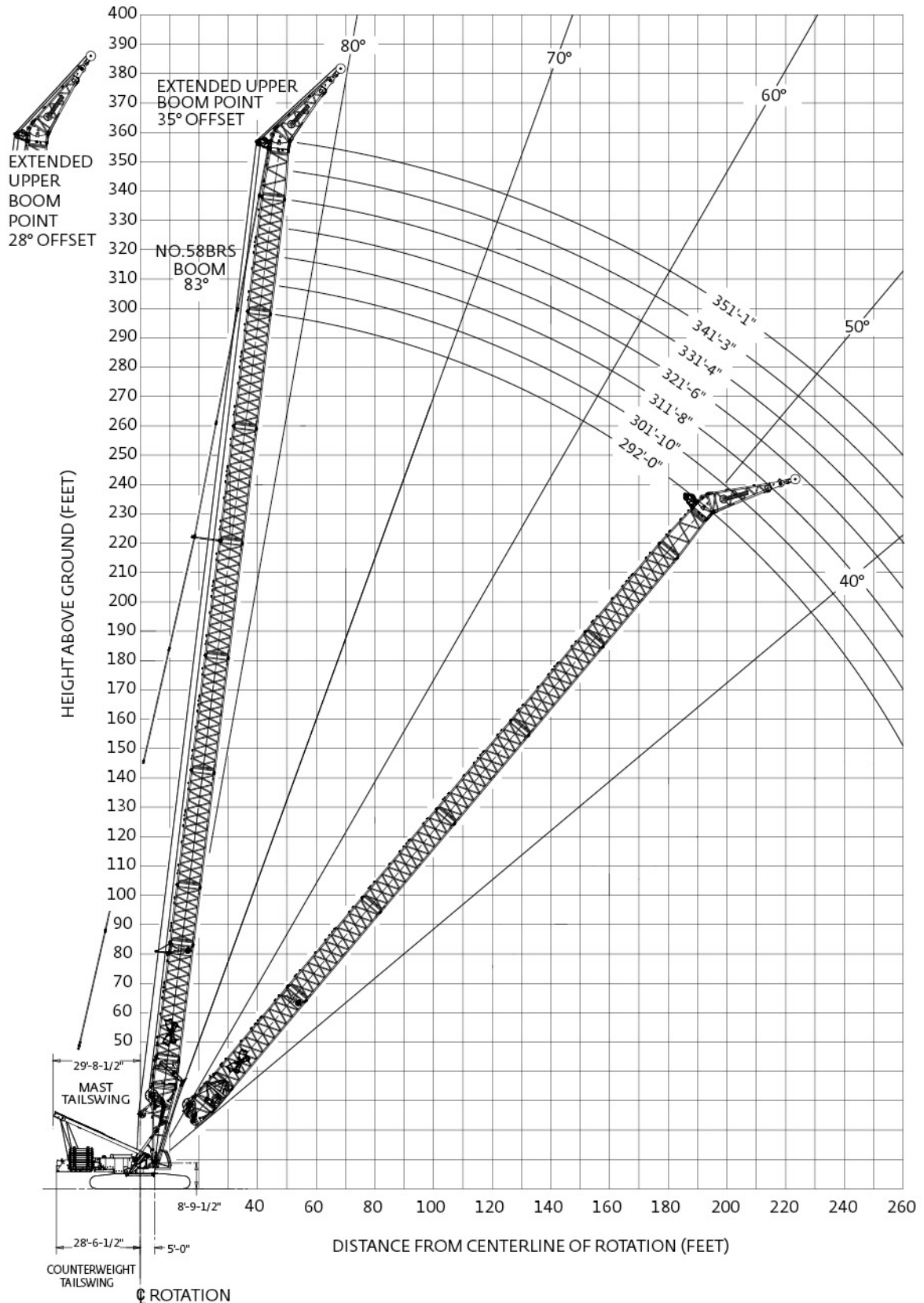

Wind Attachment load charts

with Boom Raising System

360° Rating, lb x 1 000

No. 58 WA with BRS with 24.9 ft extended upper boom point

368,000 lb Counterweight
120,000 lb Carbody counterweight
41,300 lb Auxiliary counterweight

Radius ft	28° offset Boom length ft							35° offset Boom length ft						
	292.0	301.8	311.7	321.5	331.4	341.2	351.1	292.0	301.8	311.7	321.5	331.4	341.2	351.1
60	255.8	239.9	236.0	233.1				246.9	233.1	224.0				
65	236.5	234.2	232.5	230.2	220.1	200.9	193.8	238.3	232.9	217.6	211.4	205.1	189.7	
70	214.4	212.2	210.6	208.4	211.5	197.5	192.1	216.1	214.0	212.6	210.5	202.2	186.7	182.2
80	178.6	176.6	175.1	173.1	176.0	175.2	173.7	180.1	178.1	176.8	174.8	177.8	177.0	175.6
90	151.0	149.0	147.5	145.6	148.0	147.7	146.4	152.2	150.3	149.0	147.2	149.8	149.4	148.0
100	128.4	126.7	125.3	123.7	125.3	125.0	123.8	129.7	128.2	126.9	125.3	126.9	126.6	125.4
110	110.1	108.4	107.1	105.4	107.0	106.7	105.4	111.4	109.8	108.4	106.8	108.4	108.1	106.8
120	95.0	93.3	91.9	90.3	91.8	91.5	90.2	96.1	94.5	93.1	91.6	93.0	92.7	91.5
130	82.3	80.6	79.2	77.6	79.0	78.7	77.4	83.3	81.6	80.3	78.7	80.1	79.8	78.6
140	71.4	69.7	68.3	66.7	68.1	67.8	66.5	72.3	70.7	69.3	67.7	69.1	68.8	67.6
150	62.0	60.3	59.0	57.3	58.7	58.4	57.1	62.8	61.2	59.9	58.3	59.6	59.3	58.1
160	53.8	52.1	50.8	49.2	50.5	50.2	48.9	54.5	52.9	51.6	50.0	51.3	51.1	49.8
170	46.5	44.9	43.6	41.9	43.2	43.0	41.7	47.2	45.6	44.3	42.7	44.0	43.8	42.5
190	34.3	32.7	31.4	29.8	31.1	30.8	29.6	34.9	33.3	32.0	30.4	31.7	31.5	30.2
210	24.4	22.8	21.6	20.0	21.2	21.0	19.7	24.9	23.3	22.1	20.5	21.7	21.5	20.3
230	16.2	14.6	13.4	11.8	13.0	12.8	11.6	16.5	15.0	13.8	12.2	13.5	13.3	12.1
245	10.8							11.1						

For complete chart, refer to www.cranelibrary.com.

Fixed jib range diagram

No. 58 HL boom with No. 133A fixed jib

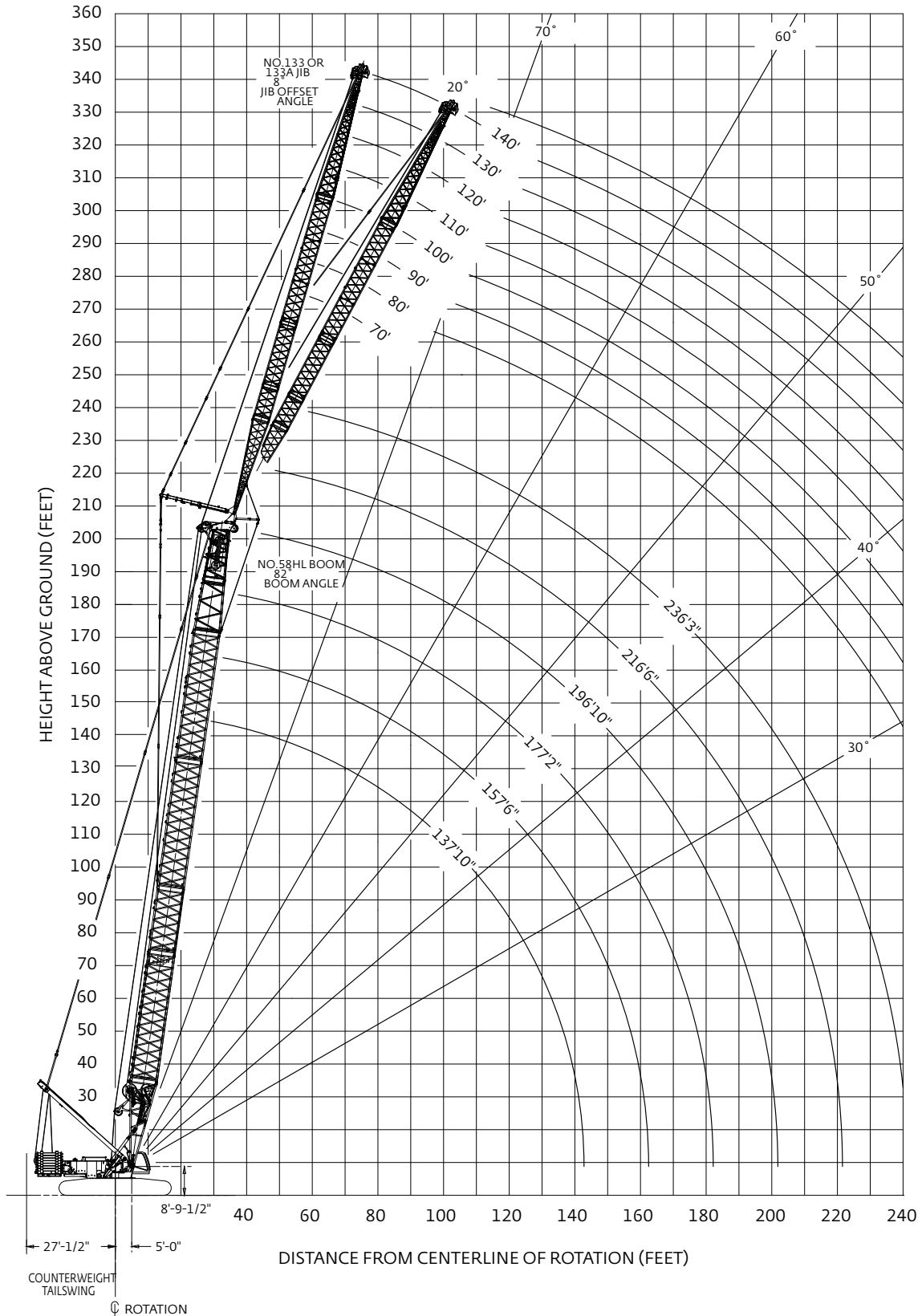

Fixed jib load charts

360° Rating, lb x 1 000

No. 58 HL boom with No. 133A fixed jib

332,000 lb Counterweight
120,000 lb Carbody counterweight

8° Offset
Boom length ft

Radius ft	137.8	157.5	177.2	196.9	216.5
50	205.7				
70	182.9	185.5	187.8	188.1	173.8
90	133.9	132.6	131.2	129.7	128.5
110	99.3	97.8	96.3	94.7	93.4
130	76.4	74.8	73.3	71.6	70.2
150	60.0	58.3	56.9	55.1	53.7
170	47.7	46.0	44.6	42.8	41.4
190	38.0	36.4	35.0	33.2	31.8
210		28.5	27.2	25.5	24.1
240				16.3	14.9
265					8.8

70 ft fixed jib length

20° Offset
Boom length ft

Radius ft	137.8	157.5	177.2	196.9	216.5
50					
70	137.1	141.7	145.1	148.5	
90	115.7	120.9	124.6	128.5	132.0
110	100.1	101.5	100.3	99.0	98.0
130	78.9	77.6	76.4	75.0	73.8
150	61.9	60.5	59.3	57.9	56.7
170	49.1	47.7	46.5	45.0	43.8
190		37.6	36.5	35.0	33.7
210			28.3	26.8	25.6
240					16.0
265					

70 ft fixed jib length

8° Offset
Boom length ft

Radius ft	137.8	157.5	177.2	196.9	216.5
60	154.5				
80	138.0	140.1	142.1	142.8	140.9
100	117.1	115.9	114.4	113.0	118.8
120	88.9	87.5	86.0	84.4	83.1
140	69.5	68.0	66.5	64.8	63.4
160	55.3	53.6	52.1	50.4	49.0
180	44.4	42.7	41.2	39.4	38.0
200	35.6	34.0	32.5	30.8	29.3
220		26.8	25.4	23.7	22.2
250				15.2	13.7
275					8.0

90 ft fixed jib length

20° Offset
Boom length ft

Radius ft	137.8	157.5	177.2	196.9	216.5
60					
80	104.0	107.3	109.2		
100	89.0	92.8	95.0	97.6	99.9
120	77.8	81.7	84.0	86.8	88.2
140	69.0	71.2	70.0	68.6	67.5
160	57.5	56.2	55.0	53.6	52.4
180	46.1	44.7	43.5	42.0	40.8
200		35.5	34.3	32.8	31.6
220			26.8	25.3	24.1
250					15.1
275					

90 ft fixed jib length

For complete chart, refer to www.cranelibrary.com.

Fixed jib load charts

360° Rating, lb x 1 000

No. 58 HL boom with No. 133A fixed jib

332,000 lb Counterweight
120,000 lb Carbody counterweight

8° Offset
Boom length ft

Radius ft	137.8	157.5	177.2	196.9	216.5
70	114.8	115.4			
90	102.3	103.9	105.5	106.2	106.0
110	91.9	94.1	96.2	97.6	98.0
130	80.2	78.7	77.2	75.6	74.3
150	63.6	62.0	60.5	58.8	57.4
170	51.2	49.5	47.9	46.2	44.8
190	41.5	39.8	38.2	36.4	35.0
210	33.7	31.9	30.4	28.6	27.1
230	27.2	25.5	23.9	22.2	20.6
260		17.5	16.1	14.3	12.8
285				9.0	7.6

120 ft fixed jib length

20° Offset
Boom length ft

Radius ft	137.8	157.5	177.2	196.9	216.5
70					
90	85.2				
110	74.3	76.0	96.2	79.4	80.7
130	65.4	67.4	69.4	71.3	72.8
150	58.3	60.5	62.6	63.3	62.2
170	52.5	52.6	51.4	50.0	48.8
190	43.7	42.3	41.0	39.6	38.4
210	35.4	34.0	32.7	31.2	30.0
230		27.1	25.8	24.3	23.1
260				15.9	14.7
285					8.9

120 ft fixed jib length

8° Offset
Boom length ft

Radius ft	137.8	157.5	177.2	196.9
75	96.1			
95	85.5	86.7	88.1	88.6
115	76.5	78.2	80.0	81.1
135	68.9	70.9	73.0	72.2
155	60.4	59.7	58.1	56.5
175	49.4	47.9	46.3	44.6
195	40.2	38.6	37.0	35.3
215	32.8	31.1	29.5	27.8
250	22.6	20.9	19.4	17.6
275		15.1	13.6	11.9
300				7.0

140 ft fixed jib length

20° Offset
Boom length ft

Radius ft	137.8	157.5	177.2	196.9
75				
95				
115	62.7	63.9	65.3	66.3
135	55.2	56.7	58.2	59.5
155	49.1	50.8	52.4	53.9
175	44.1	45.9	47.6	48.8
195	40.0	41.5	40.2	38.8
215	34.9	33.5	32.2	30.8
250		22.5	21.3	19.8
275			15.0	13.6
300				

140 ft fixed jib length

For complete chart, refer to www.cranelibrary.com.

Luffing jib range diagram

No. 58 HL boom with No. 59 luffing jib

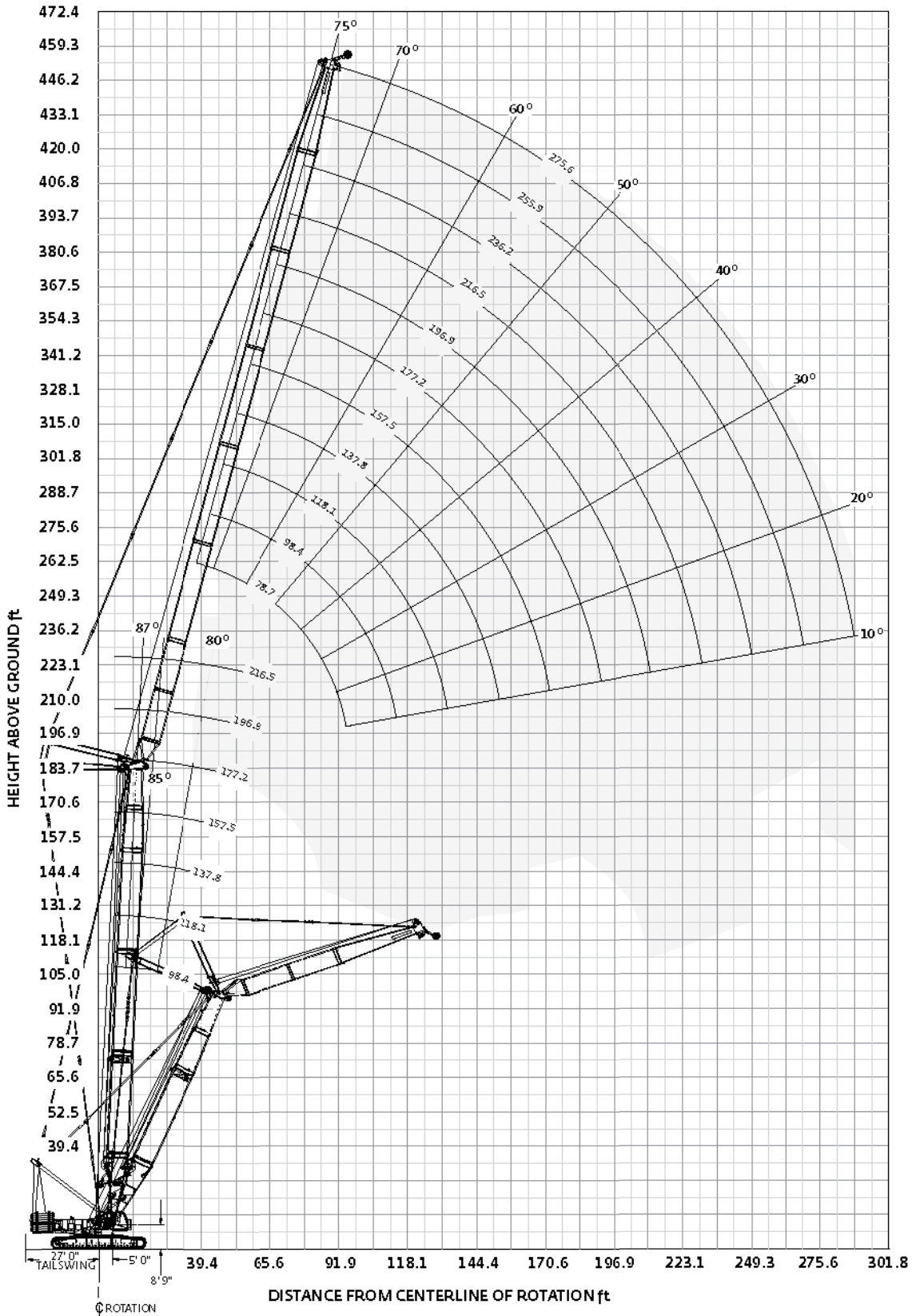

Luffing jib load charts

360° Rating, lb x 1000

No. 58 HL boom with No. 59 luffing jib

332,000 lb Counterweight 120,000 lb Carbody counterweight

87° Boom angle

Radius ft	Boom length ft				Radius ft	Boom length ft				Radius ft	Boom length ft			
	98.4	137.8	177.2	216.5		98.4	137.8	177.2	196.9		98.4	137.8	177.2	196.9
38	408.5				50	300.2	252.6			60	236.8	203.2		
45	354.2	333.0	262.3	222.2	55	278.3	242.0	205.4	194.5	75	191.9	175.1	151.1	142.9
60	260.7	244.8	213.0	184.8	60	258.6	227.5	194.3	184.4	80	176.5	166.8	144.3	136.6
75	194.7	194.5	174.9	154.3	75	193.7	190.3	165.1	157.0	100	132.2	131.8	120.9	144.6
90	147.9	147.8	144.3	129.5	90	153.3	152.9	141.2	134.6	115	110.2	109.9	106.2	100.7
105					105	125.8	125.5	121.7	115.8	125	98.8	98.6	97.7	92.5
125					125	100.2	100.0	98.5	94.7	140	85.0	84.8	84.4	81.5
145					145					155	74.0	73.8	73.4	71.7
175					175					175				54.3
185					185					185				
195					195					195				

Radius ft	Boom length ft				Radius ft	Boom length ft			Radius ft	Boom length ft		
	98.4	137.8	177.2	196.9		98.4	137.8	177.2		98.4	137.8	177.2
70	189.7	162.2			70				70			
80	172.5	151.1	128.1	114.1	80	132.1	115.1		80			
95	139.2	133.6	114.7	107.3	95	127.7	112.4	94.6	95	93.3	83.3	70.9
115	108.2	107.8	98.3	92.8	115	105.8	103.7	88.0	115	89.2	80.5	68.9
135	87.2	86.9	84.4	79.7	135	84.8	84.5	78.1	135	82.5	77.7	65.2
160	69.0	68.7	68.3	65.9	160	66.6	66.3	65.7	160	64.2	63.9	57.4
185	55.9	55.7	55.3	54.4	185	53.5	53.3	52.9	185	51.2	50.9	49.8
210	40.7	40.5	40.3	40.1	210	43.7	43.5	43.2	210	41.5	41.2	40.9
240					240	34.6	32.5	31.6	240	32.5	32.3	32.0
280					280				280	21.4	19.5	18.4
290					290				290		14.2	14.0

For complete chart, refer to www.cranelibrary.com.

Luffing jib load charts

360° Rating, lb x 1 000

No. 58 HL boom with No. 59 luffing jib

332,000 lb Counterweight 120,000 lb Carbody counterweight

75° Boom angle

Radius ft	Boom length ft			
	98.4	137.8	177.2	216.5
80	163.2			
90	140.3	133.9		
95	130.9	124.9		
105	114.9	109.7	103.4	96.0
120		91.8	213.0	80.5
125			82.1	76.3
140				65.1
155				
175				
180				
185				

Radius ft	Boom length ft			
	98.4	137.8	177.2	196.9
80				
90				
95	128.9			
105	113.3	107.4		
120	95.2	90.2	84.4	81.0
125	90.3	125.5	79.9	76.7
140	77.5	85.5	68.6	65.8
155		63.7	59.5	57.1
175				47.5
180				
185				

Radius ft	Boom length ft			
	98.4	137.8	177.2	196.9
110	104.2			
120	92.9	87.5		
125	87.9	82.8		
135	79.3	74.6	69.2	
140	75.5	71.0	65.8	62.8
145	71.9	67.6	62.6	59.8
155	65.6	61.6	56.9	54.3
165	60.0	56.3	52.0	49.6
185	50.6	47.5	43.7	41.6
200		41.8	38.6	36.7
215				32.2

Radius ft	Boom length ft			
	98.4	137.8	177.2	196.9
135	76.7			
145	69.4	64.9		
160	60.3	56.2	51.5	48.9
180	50.6	47.0	42.9	40.6
200	42.9	39.8	36.1	34.0
220	36.6	33.8	30.5	28.7
240		28.6	25.8	24.2
250			23.6	22.1
265				
280				
300				

Radius ft	Boom length ft		
	98.4	137.8	157.5
135			
145			
160	57.4	53.1	
180	47.8	44.1	41.9
200	40.2	36.9	35.0
220	31.4	31.1	29.3
240	28.9	26.2	24.7
250	26.7	24.1	22.6
265		—	—
280		18,2	17,1
300			

Radius ft	Boom length ft
	98.4
135	
145	
160	
180	45.1
200	37.6
220	31.5
240	26.4
250	24.2
265	—
280	18.5
300	15.2

For complete chart, refer to www.cranelibrary.com.

Luffing jib load charts

360° Rating, lb x 1000

No. 58 HL boom with No. 59 luffing jib				
332,000 lb Counterweight 120,000 lb Carbody counterweight				
65° Boom angle				
Radius ft	Boom length ft			
	98.4	137.8	177.2	216.5
105	105.7			
120	88.7	80.8		
135		68.9		
145		61.9	60.6	
160			47.2	39.8
175				34.3
185				
200				
205				
225				
240				

Radius ft	Boom length ft			
	98.4	137.8	177.2	196.9
105				
120				
135	74.0			
145	67.1	60.1		
160	58.4	52.2	44.9	
175		45.7	39.2	35.4
180		43.7	34.3	33.8
200			31.2	28.2
205				26.9
225				
240				

Radius ft	Boom length ft		
	98.4	137.8	177.2
105			
120			
135			
145			
160	56.1		
175	49.2	43.1	
180	47.1	41.2	
200	39.9	34.8	28.7
205	38.2	33.3	27.5
225			23.0
240			19.8

Radius ft	Boom length ft	
	98.4	137.8
180	44.5	
185	42.6	
190	40.8	34.9
200	37.5	31.9
210	34.5	29.3
225	30.5	25.7
240	26.9	22.5
245	25.7	21.5
250		20.6
260		18.7
280		

Radius ft	Boom length ft
	98.4
180	
185	
190	
200	34.5
210	31.6
225	27.7
240	24.3
245	23.2
250	22.2
260	20.3
280	16.8

For complete chart, refer to www.cranelibrary.com.

Outline dimensions

MAX-ER®

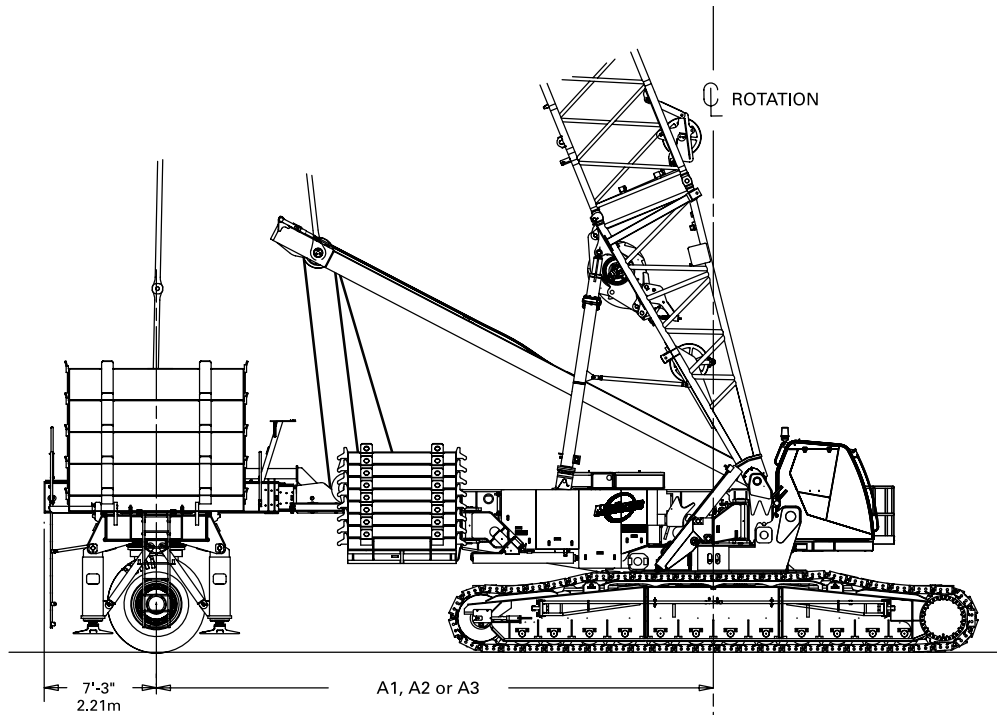

- A1 36'-1" (11m WORKING POSITION)
- A2 42'-8" (13m WORKING POSITION)
- A3 49'-3" (15m WORKING POSITION)

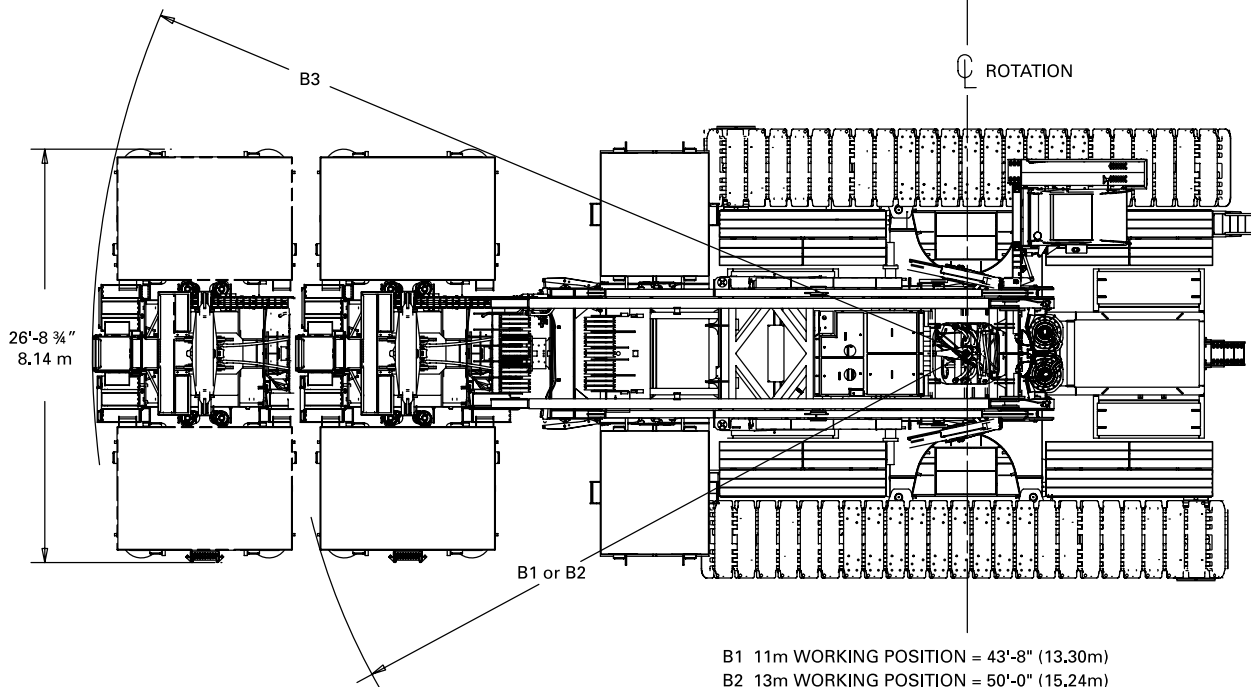

- B1 11m WORKING POSITION = 43'-8" (13.30m)
- B2 13m WORKING POSITION = 50'-0" (15.24m)
- B3 15m WORKING POSITION = 56'-6" (17.22m)

Outline dimensions

MAX-ER®

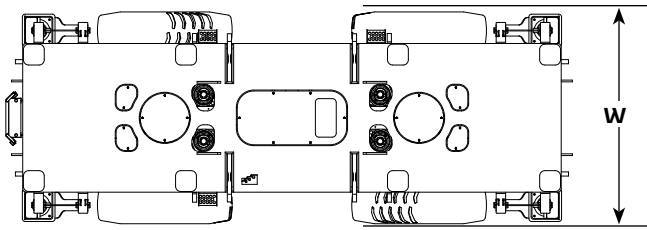

Wheeled carrier (US)

Length	26' 9"
Width	10' 0"
Height	9' 10"
Weight	62,400 lb

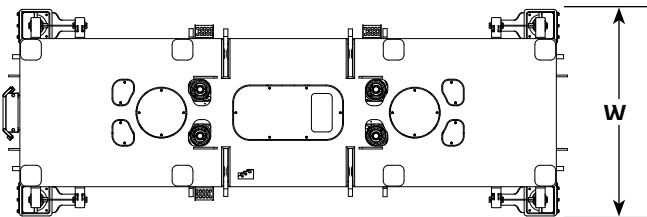
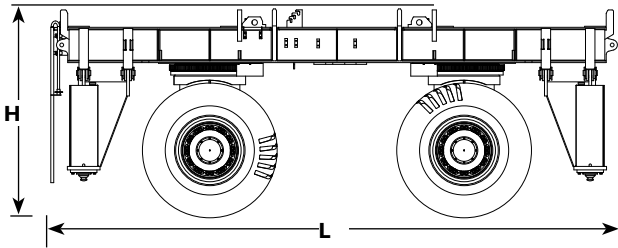

Wheeled carrier (European)

Length	26' 9"
Width	9' 9"
Height	9' 10"
Weight	63,100 lb

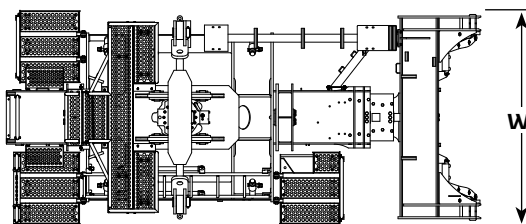
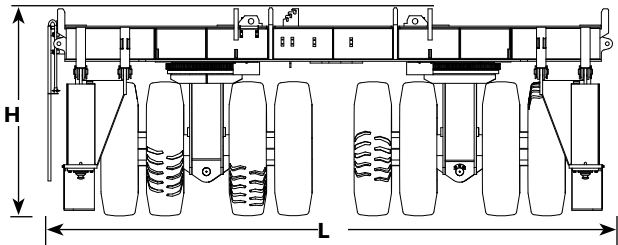

Lifting frame and telescopic beam

Length	19' 10"
Width	8' 11"
Height	9' 9"
Weight	37,100 lb

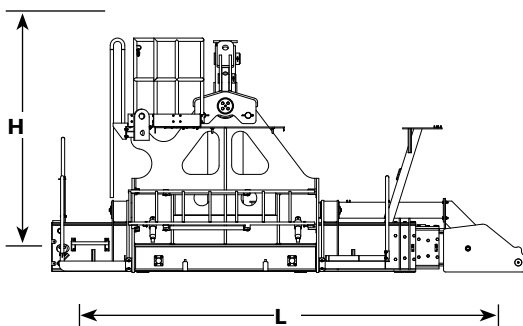

Outline dimensions

MAX-ER®

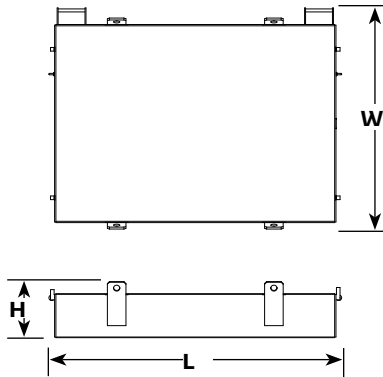

Side counterweight

Length	11' 9"
Width	8' 11"
Height	2' 3"
Weight	30,000 lb

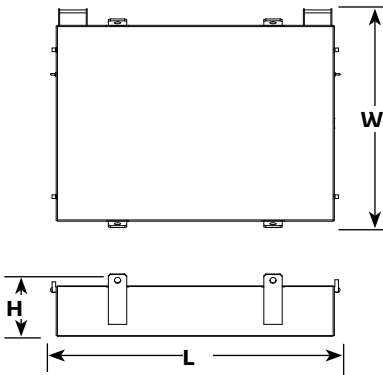

Side counterweight

Length	11' 9"
Width	8' 11"
Height	2' 6"
Weight	44,000 lb

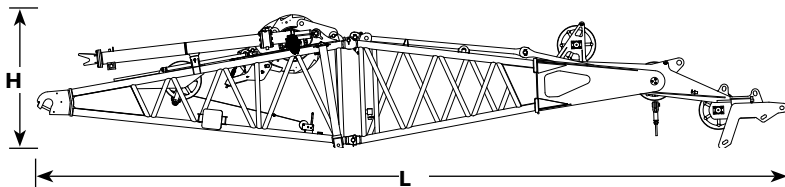

No. 59A mast butt and top package, drum, wire rope, equilizer

Length	48' 8"
Width	9' 10"
Height	8' 9"
Weight	45,400 lb

Outline dimensions

MAX-ER®

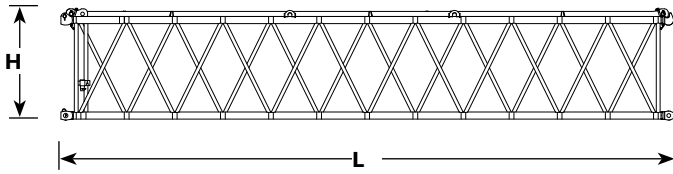

394' No. 59A mast insert

Length	40' 0"
Width	8' 11"
Height	7' 4"
Weight	9,645 lb

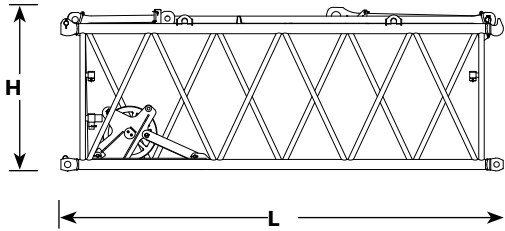

198' No. 59A mast insert

Length	20' 4"
Width	8' 11"
Height	7' 6"
Weight	7,420 lb

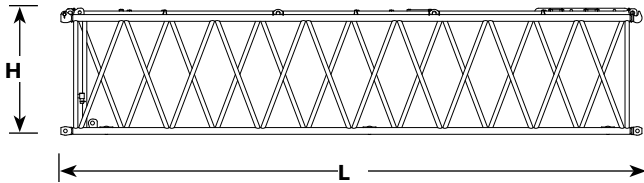

394' No. 58 heavy boom insert with equilibrizer rails

Length	40' 0"
Width	9' 9"
Height	8' 9"
Weight	10,145 lb

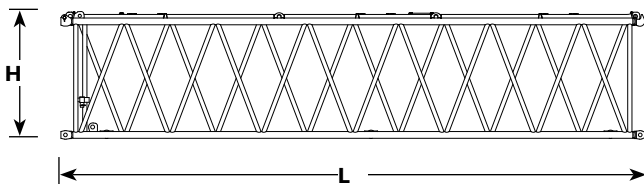

394' No. 58 heavy boom insert

Length	40' 0"
Width	9' 9"
Height	8' 9"
Weight	11,215 lb

Boom combinations with mast

No. 58 HL boom combinations					
Boom length ft	Boom inserts length ft				
	16.4°	19.7	39.4	39.4 ^{oo}	39.4 ^{ooo}
137.8	1	0	0	1	1
157.5	1	1	0	1	1
177.2	1	0	1	1	1
196.9	1	1	1	1	1
216.5	1	0	2	1	1
236.2	1	1	2	1	1
255.9	1	0	3	1	1
275.6	1	1	3	1	1
295.3	1	0	4	1	1
315.0	1	1	4	1	1

*transition boom insert.

**with auxiliary sheave insert.

*** with equalizer rails insert.

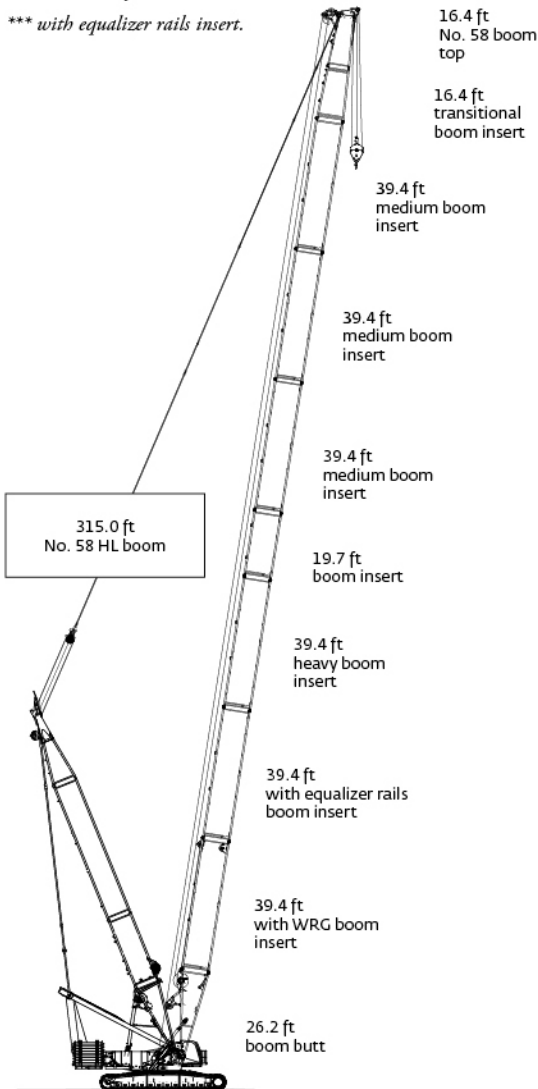

No. 58 HL boom with 23 ft extended upper boom point combination						
Boom length ft	Boom inserts length ft					
	16.4°	19.7	39.4 medium	39.4 ^{oo}	39.4 ^{ooo}	39.4 heavy
315.0	1	1	3	1	1	1

*transition boom insert.

**with auxiliary sheave insert.

*** with equalizer rails insert.

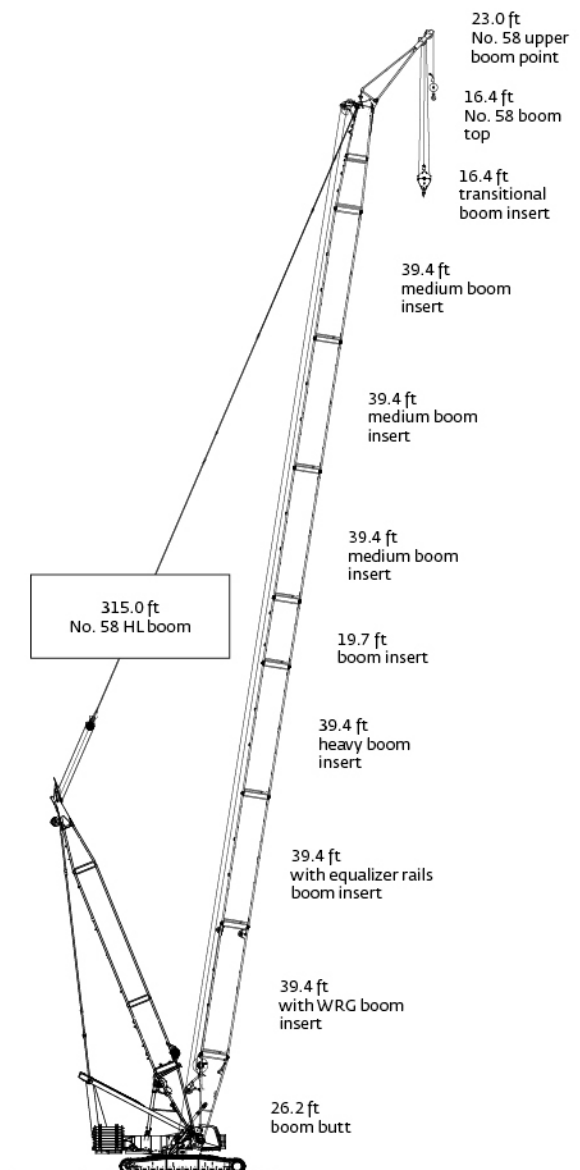

Boom combinations

MAX-ER®

No. 58 HL boom combinations						
Boom length ft	Boom inserts length ft					
	16.4°	19.7	39.4 medium	39.4°	39.4°**	39.4 heavy
137.8	1	0	0	1	1	0
157.5	1	1	0	1	1	0
177.2	1	0	0	1	1	1
196.9	1	1	0	1	1	1
216.5	1	0	1	1	1	1
236.2	1	1	1	1	1	1
255.9	1	0	2	1	1	1
275.6	1	1	2	1	1	1
295.3	1	0	3	1	1	1
315.0	1	1	3	1	1	1
334.6	1	0	4	1	1	1
354.3	1	1	4	1	1	1
374.0	1	0	5	1	1	1
393.7	1	1	5	1	1	1

*transition boom insert.

**with auxiliary sheave insert.

*** with equalizer rails insert.

No. 59 luffing jib combinations		
Luffing jib length ft	Luffing jib inserts length ft	
	19.7	39.4
78.7	1	0
98.4	0	1
118.1	1	1
118.1	0	2
157.5	1	2
177.24	0	3
196.9	1	3
216.5	0	4
236.2	1	4
255.9	0	5
275.6	1	5

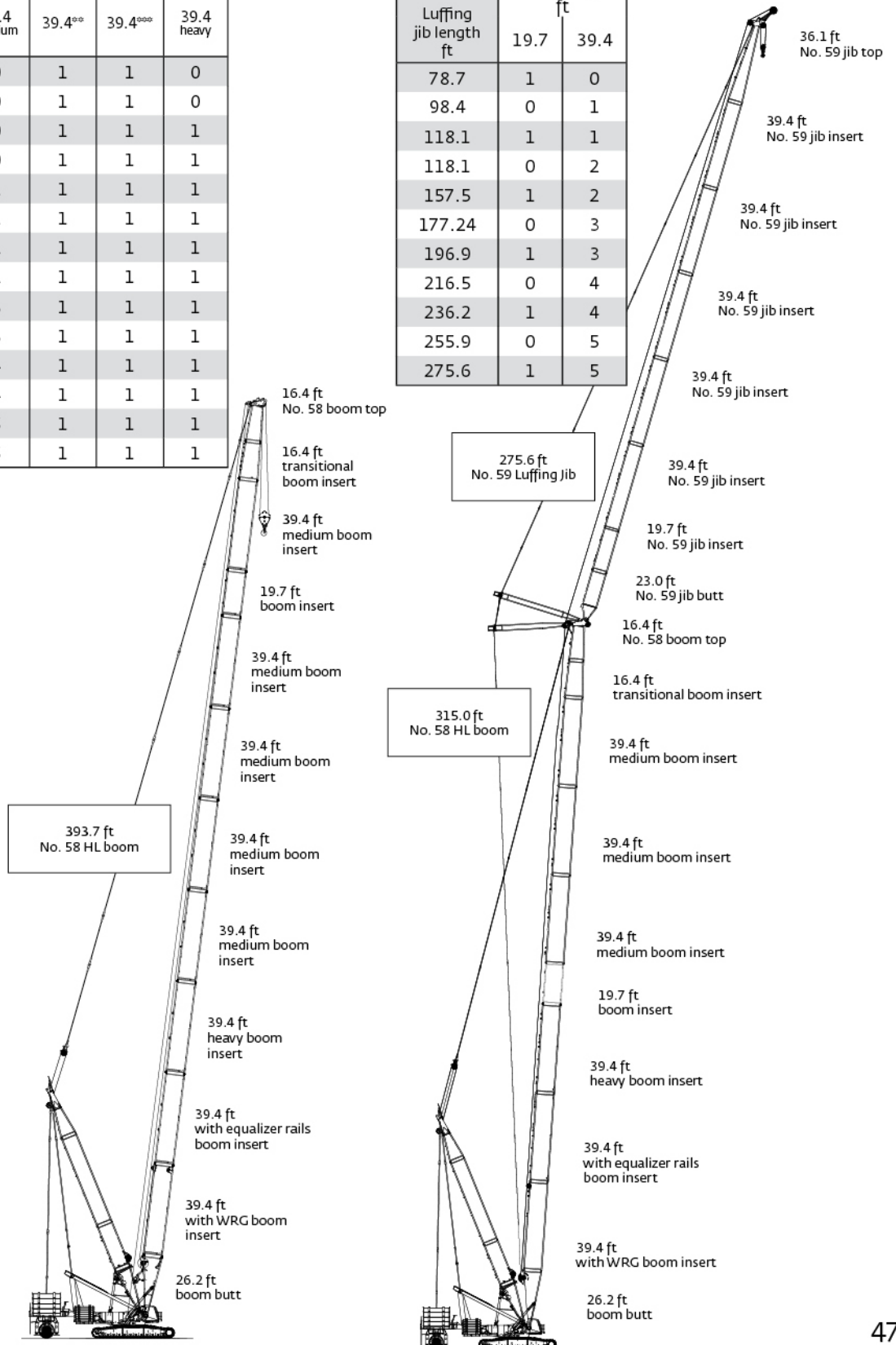

Boom range diagram with Mast

No. 58 HL boom with 98.4 ft No.59A mast

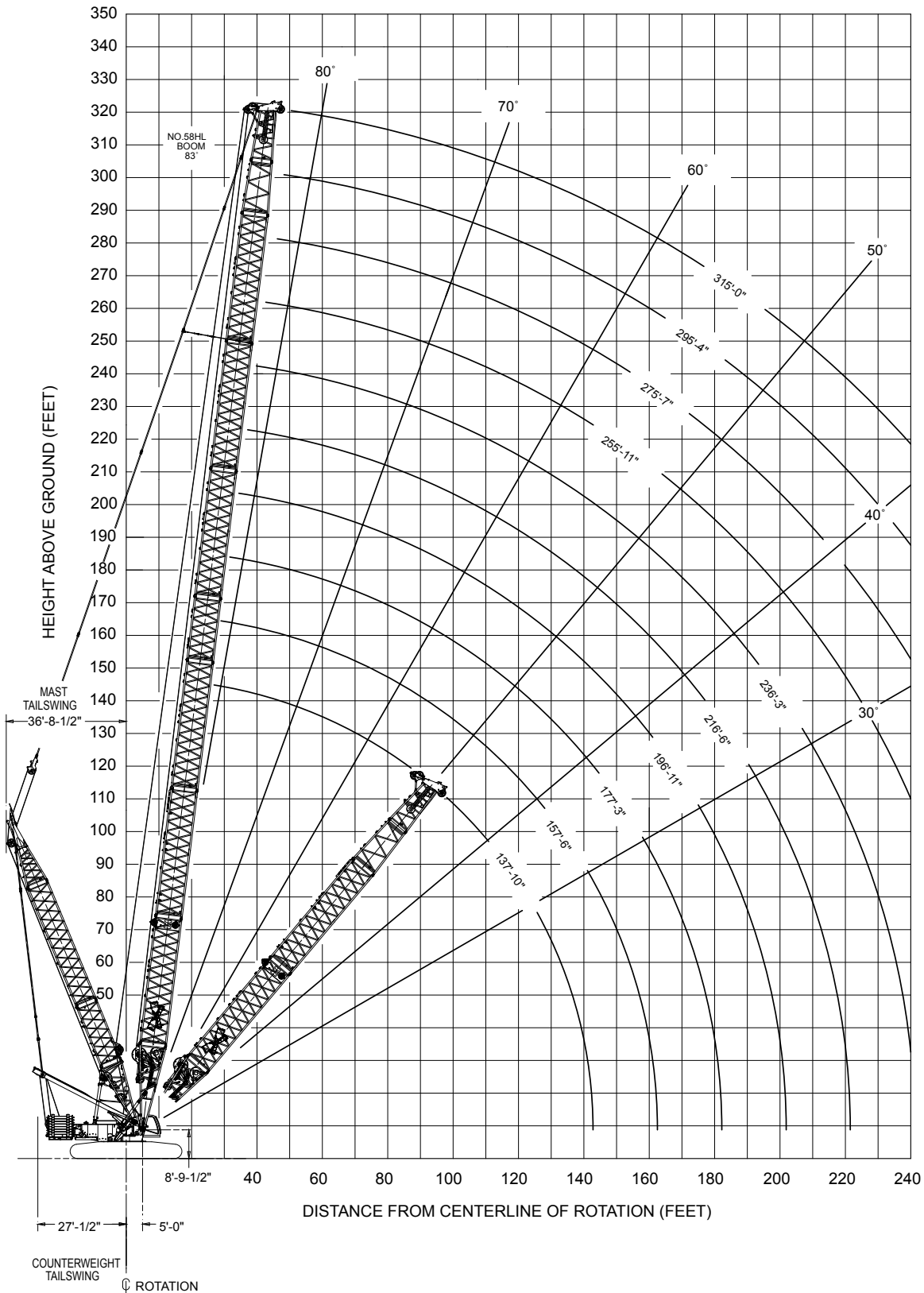

Boom load charts

with Mast

360° Rating, lb x1000

No. 58 HL boom with 98.4 ft No.59A mast

Radius ft	349,600 lb Counterweight 120,000 lb Carbody counterweight									
	Boom length ft									
	137.8	157.5	177.2	196.9	216.5	236.2	255.9	275.6	295.3	315.0
26	738.6									
40	464.6	465.2	465.3	465.2	465.8	465.3	452.3			
50	331.9	332.1	331.9	331.4	331.6	330.9	330.5	329.6	327.2	279.8
65	227.4	227.2	226.6	225.8	225.9	224.8	224.2	223.0	222.4	221.2
80	169.1	168.6	167.9	167.0	166.9	165.7	164.9	163.6	163.0	178.2
90	142.6	142.1	141.4	140.4	140.3	139.0	138.1	136.8	136.1	134.5
105	113.6	113.0	112.2	111.1	111.0	109.7	108.7	107.3	106.6	104.9
120	92.5	91.9	91.1	90.0	89.8	88.5	87.5	86.0	85.2	83.6
130	81.4	80.8	80.0	78.8	78.7	77.3	76.3	74.8	74.0	72.3
145		67.2	66.4	65.2	65.1	63.7	62.7	61.1	60.4	58.6
155			58.8	57.7	57.5	56.2	55.2	53.6	52.8	51.1
170			49.2	48.2	48.0	46.6	45.6	44.1	43.3	41.5
185				40.2	40.1	38.7	37.7	36.2	35.4	33.6
195					35.5	34.1	33.2	31.6	30.8	29.0
210					29.3	28.1	27.1	25.6	24.8	23.0
230						21.1	2.3	18.8	18.1	15.9
260								9.1		

Extended upper boom point range diagram

No. 58 HL boom with 98.4 ft No. 59A mast and 23 ft extended upper boom point

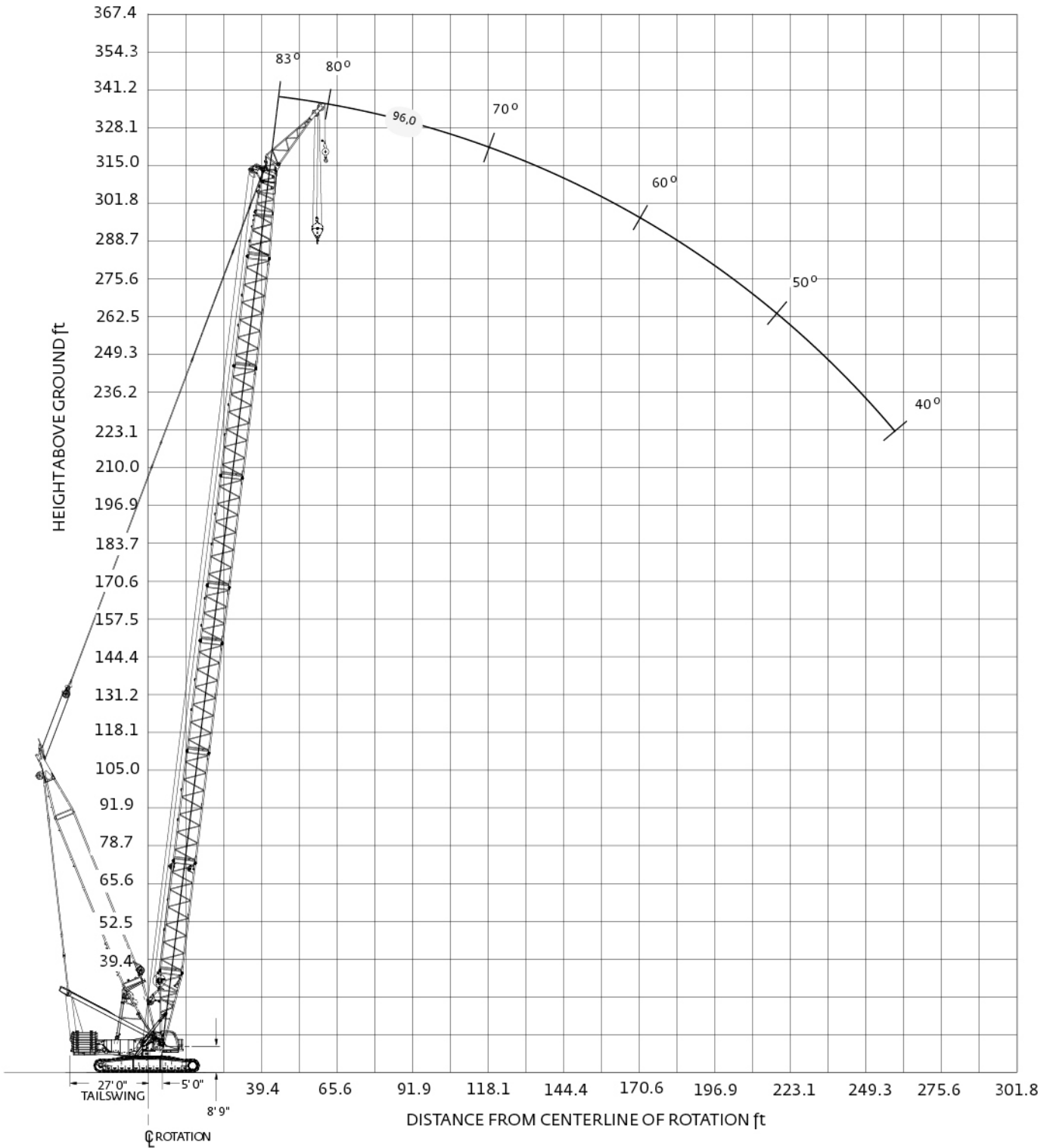

Extended upper boom point load charts

360° Rating, lb x 1000

No. 58 HL boom with 98.4 ft No. 59A mast and 23 ft extended upper boom point	
Radius ft	332,000 lb Counterweight 120,000 lb Carbody counterweight
	Boom length ft
	315.0
60	179.8
65	179.8
70	179.8
80	170.7
85	155.8
100	121.2
105	112.2
110	104.1
115	96.8
125	84.1
140	68.7
150	60.3
165	49.8
175	43.8
190	36.1
200	31.6
210	27.6
215	25.7
230	20.6
235	19.0
245	16.0
255	12.7
260	11.1
270	8.1

For complete chart, refer to www.cranelibrary.com.

MAX-ER[®] range diagram

MAX-ER at 49.2 ft position
No. 58 HL boom with 98.4 ft No.59A mast

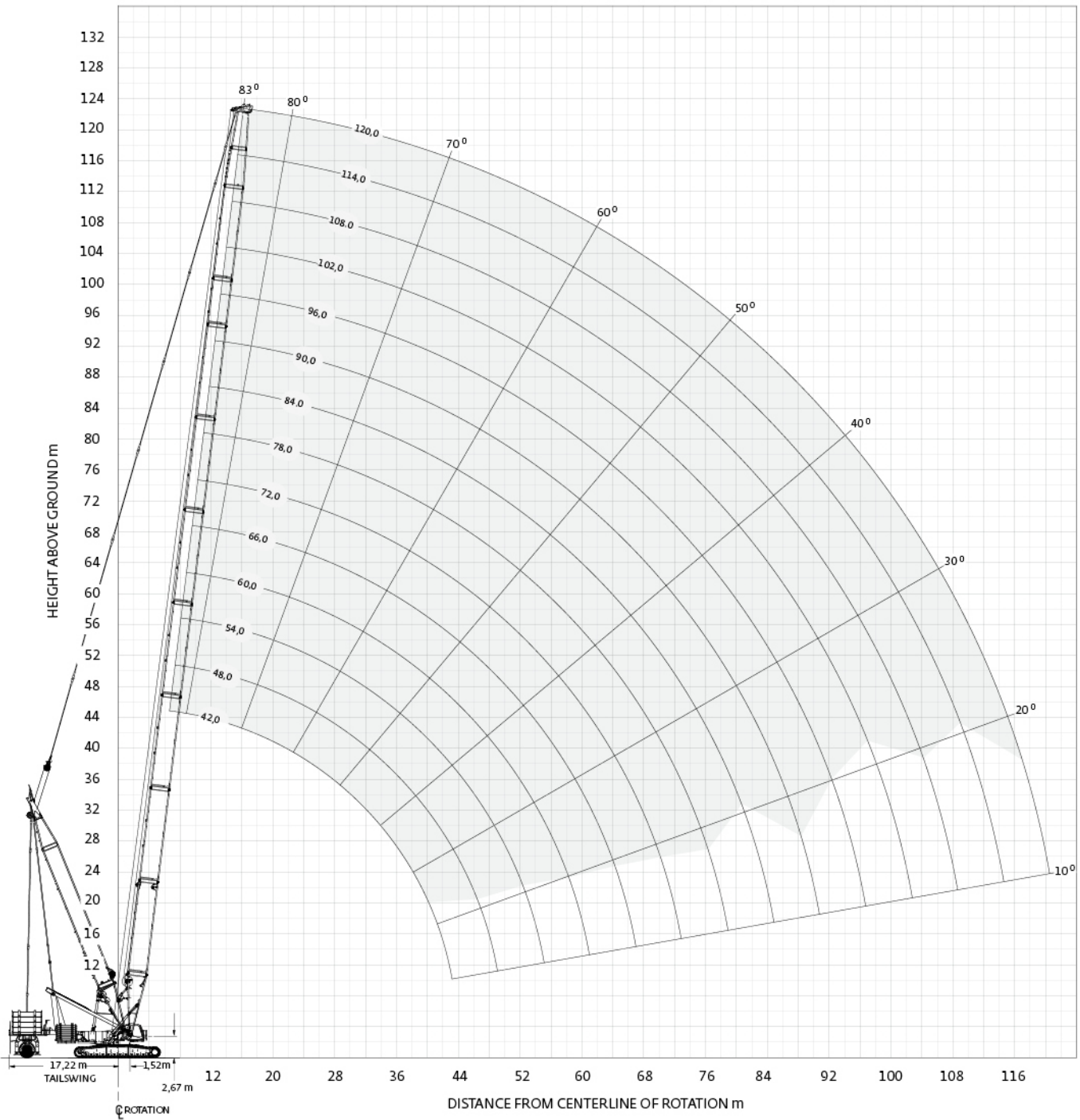

MAX-ER® load charts

360° Rating, lb x 1 000

MAX-ER at 49.2 ft position No. 58 HL boom with 98.4 ft No.59A mast														
Radius ft	332,000 lb Counterweight 120,000 lb Carbody counterweight 511,400 lb Wheeled counterweight													
	Boom length ft													
	137.8	157.5	177.2	196.9	216.5	236.2	255.9	275.6	295.3	315.0	334.6	354.3	374.0	393.7
26	837.4													
34	837.4	749.7	688.1	623.6										
40	837.4	749.7	686.4	622.6	553.8	502.3	452.3							
50	728.0	726.9	675.6	605.4	545.6	491.5	445.5	390.3	327.2	279.8	237.7			
60	605.2	604.1	602.7	587.1	530.8	479.2	437.8	390.3	327.2	279.8	237.7	205.0	175.7	152.1
70	516.4	515.2	513.9	512.3	511.7	466.9	430.3	386.1	327.2	279.8	237.7	204.7	175.4	151.8
80	449.1	448.0	446.7	445.1	444.5	442.8	422.9	374.3	319.1	279.8	237.4	204.4	174.9	151.3
100	354.1	352.9	351.6	350.1	349.6	347.8	346.5	344.7	300.8	278.9	234.5	200.4	170.8	147.8
120	289.9	288.9	287.6	286.1	285.6	283.9	282.6	280.8	279.8	273.1	229.4	195.9	166.7	142.0
140		242.7	241.5	240.0	239.6	237.9	236.6	234.8	233.8	231.8	224.3	191.4	162.5	134.0
160			206.6	205.2	204.8	203.2	202.0	200.1	199.2	197.2	196.0	186.8	158.4	126.0
180				177.9	177.6	176.0	174.8	173.0	172.1	170.1	168.9	167.0	154.4	118.0
200					155.2	153.7	152.6	150.9	150.0	148.1	147.0	145.2	143.9	110.0
220						135.3	134.3	132.7	131.8	129.9	128.8	127.0	125.7	102.0
240							119.0	117.4	116.6	114.7	113.6	111.8	110.6	94.0
260								104.4	103.7	101.9	100.8	99.0	97.8	86.0
280									92.6	90.8	89.8	88.0	86.8	80.0
300										81.1	80.1	78.4	77.2	75.0
330												66.1	65.0	62.8
340													56.4	58.5
350														44.3
360														27.8

For complete chart, refer to www.cranelibrary.com.

Luffing jib range diagram

MAX-ER®

MAX-ER at 49.2 ft position
 No. 58 HL boom with No. 59 luffing jib

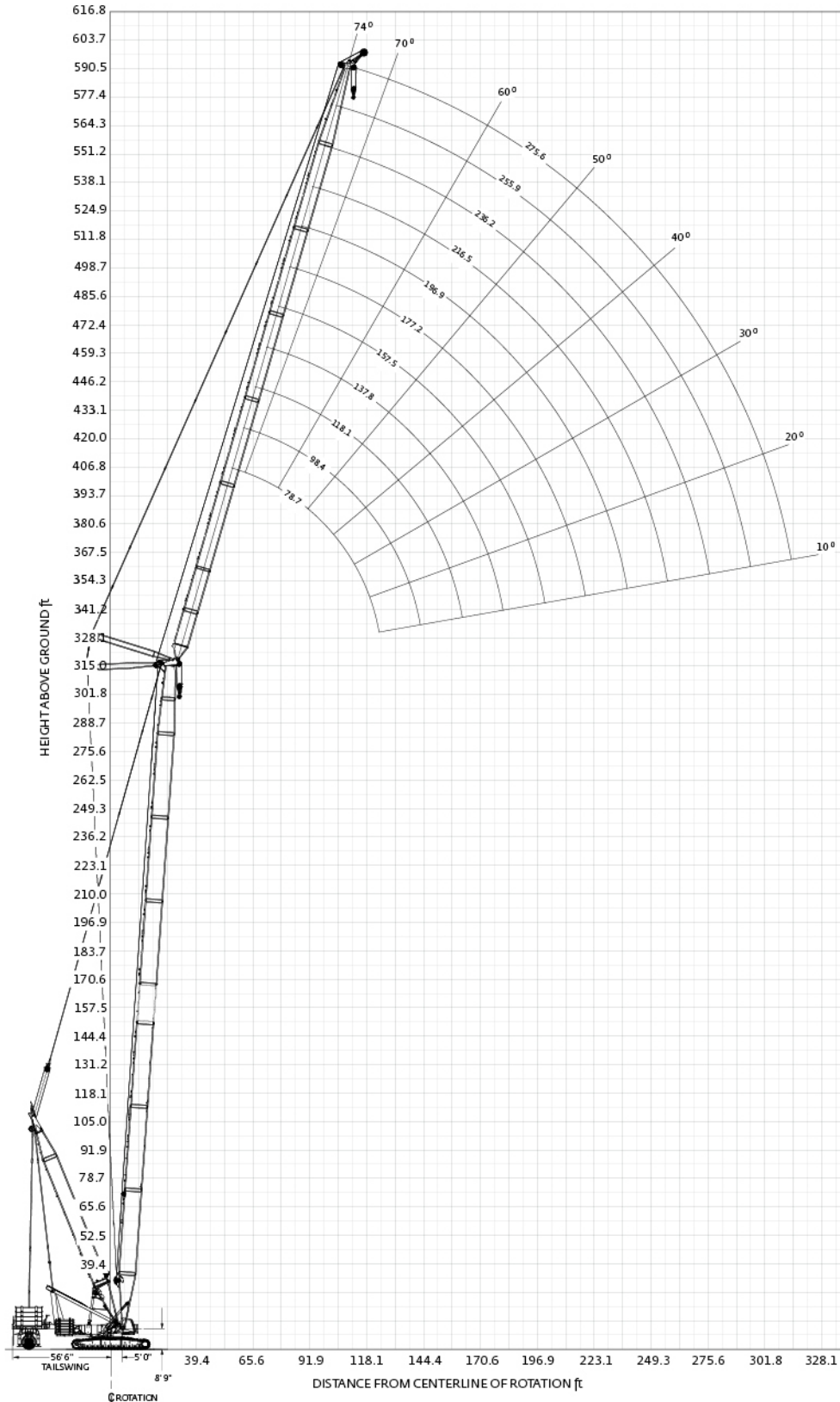

Luffing jib load charts

MAX-ER®

360° Rating, lb x 1 000

**MAX-ER at 49.2 ft position
No. 58 HL boom with No. 59 luffing jib**

**332,000 lb Counterweight 120,000 lb Carbody counterweight
511,400 lb Wheeled counterweight
86° Boom angle**

	Boom length ft				Radius ft	Boom length ft				Radius ft	Boom length ft				Radius ft
	138.0	197.0	256.0	315.0		138.0	197.0	256.0	315.0		138.0	197.0	256.0	315.0	
79.0 ft Luffing jib length	45	408.9			55	321.0			65	255.6					
	50	364.9	339.6		65	277.1	246.9	169.2	70	249.2	190.8				
	55	308.0	307.6	223.8	142.9	80	219.4	205.7	149.9	104.4	85	209.3	170.7	121.5	84.1
	60	298.5	281.8	216.0	135.9	85	205.8	193.8	143.2	101.7	100	173.7	148.4	108.5	77.6
	65	274.7	260.7	205.6	133.8	90	194.1	183.6	136.6	97.9	110	156.9	134.0	99.9	72.3
	70	255.1	243.1	195.3	131.4	105	167.5	154.8	118.0	86.9	125	138.1	114.6	87.8	64.8
	80	225.8	216.3	175.6	125.4	110	161.0	145.7	112.5	83.6	135	127.2	103.3	80.6	60.2
	85	215.3	206.6	166.7	120.2	120	150.9	130.4	102.8	77.4	150	108.0	89.3	71.3	54.2
	90	207.8	199.2	158.8	115.4	125	144.6	124.1	98.6	74.7	165	94.0	79.0	64.2	49.4
	100		160.4	147.4	107.7	135	107.6	115.1	92.2	70.3	180			60.8	46.6
105				103.8	145				68.1	185				46.6	
197.0 ft Luffing jib length					90	122.6	103.7			100	87.6				
	75	176.3			105	120.2	101.6	74.2	52.0	125	83.9	74.2	55.3	38.5	
	90	174.1	136.0	97.6	66.8	125	113.6	90.9	67.0	47.2	145	80.9	68.1	50.4	35.0
	105	157.4	123.2	89.5	63.4	145	99.7	79.6	59.3	42.2	165	75.2	60.8	45.3	31.4
	125	133.0	105.0	78.0	56.1	165	86.1	68.8	52.0	37.3	185	66.9	53.8	40.4	28.0
	135	121.3	96.3	72.4	52.6	180	76.8	61.6	47.0	34.0	205	59.2	47.4	35.8	24.9
	150	105.1	84.3	64.6	47.5	190	71.1	57.2	44.0	31.9	225	52.3	41.9	31.9	22.2
	165	91.2	74.0	57.6	43.0	210	61.3	49.6	38.7	28.4	245	46.3	37.1	28.5	19.9
	185	76.4	62.8	50.1	37.9	230	53.6	43.8	34.7	25.6	265	39.4	33.5	26.0	18.2
	200	68.1	56.7	45.8	35.0	250	40.5	40.2	32.2	23.9	285	30.2	31.1	24.4	17.1
	210	59.7	54.0	43.9	33.6	265				23.7	305				15.9
	225				33.0										

For complete chart, refer to www.cranelibrary.com.

Manitowoc Crane Care

Manitowoc Crane Care is the industry's most advanced service and support program, designed to keep your cranes up and running. Manitowoc's distributor network and customer support personnel are available to support you 24 hours a day, 7 days a week, 365 days a year. There are five key disciplines of Manitowoc Crane Care:

Parts

Genuine Manitowoc replacement parts are accessible through your distributor.

Service and technical support

Assistance with crane selection, lift planning and ground bearing calculations or field service and maintenance.

Technical publications

Operator, parts, service and capacity chart manuals are available in multiple formats in major languages.

Training

A variety of training courses are available online or through Manitowoc training centers.

EnCORE

Rebuild, repair, remanufacture or exchange your current crane through our local network, for a fraction of the cost of a new crane.

www.manitowoccranecare.com

CraneSTAR

CraneSTAR is an exclusive and innovative crane asset management system that helps improve your profitability and reduce costs by remotely monitoring critical crane data. Visit www.cranestar.com for more information.

Manitowoc Cranes

Regional headquarters

Americas

Manitowoc, Wisconsin, USA

Tel: +1 920 684 6621

Fax: +1 920 683 6277

Shady Grove, Pennsylvania, USA

Tel: +1 717 597 8121

Fax: +1 717 597 4062

Europe, Middle East, Africa

Ecully, France

Tel: +33 (0)4 72 18 20 20

Fax: +33 (0)4 72 18 20 00

China

Shanghai, China

Tel: +86 21 6457 0066

Fax: +86 21 6457 4955

Greater Asia-Pacific

Singapore

Tel: +65 6264 1188

Fax: +65 6862 4040

Regional offices

Americas

Brazil

Alphaville

Mexico

Monterrey

Chile

Santiago

Europe, Middle East,

Africa

France

Baudemont

Cergy

Decines

Germany

Langenfeld

Italy

Lainate

Netherlands

Breda

Poland

Warsaw

Portugal

Baltar

Russia

Moscow

South Africa

Johannesburg

U.A.E.

Dubai

U.K.

Buckingham

China

Beijing

Chengdu

Guangzhou

Xian

Greater Asia-Pacific

Australia

Brisbane

Melbourne

Sydney

India

Chennai

Delhi

Hyderabad

Pune

Korea

Seoul

Philippines

Makati City

Singapore

Factories

Brazil

Passo Fundo

China

TaiAn

Zhangjiagang

France

Charlieu

Moulins

Germany

Wilhelmshaven

India

Pune

Italy

Niella Tanaro

Portugal

Baltar

Fânzeres

Slovakia

Saris

USA

Manitowoc

Port Washington

Shady Grove

This document is non-contractual. Constant improvement and engineering progress make it necessary that we reserve the right to make specification, equipment, and price changes without notice. Illustrations shown may include optional equipment and accessories and may not include all standard equipment.