

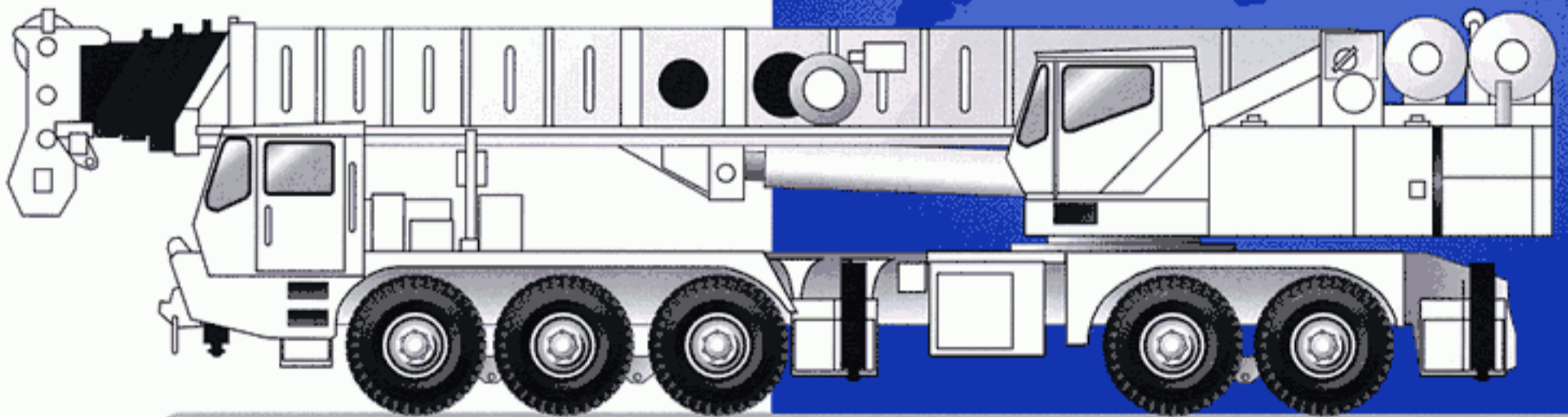

GROVE[®]
CRANE

A GROVE WORLDWIDE COMPANY

TM9150



Truck Mounted Hydraulic Crane

Dimensions

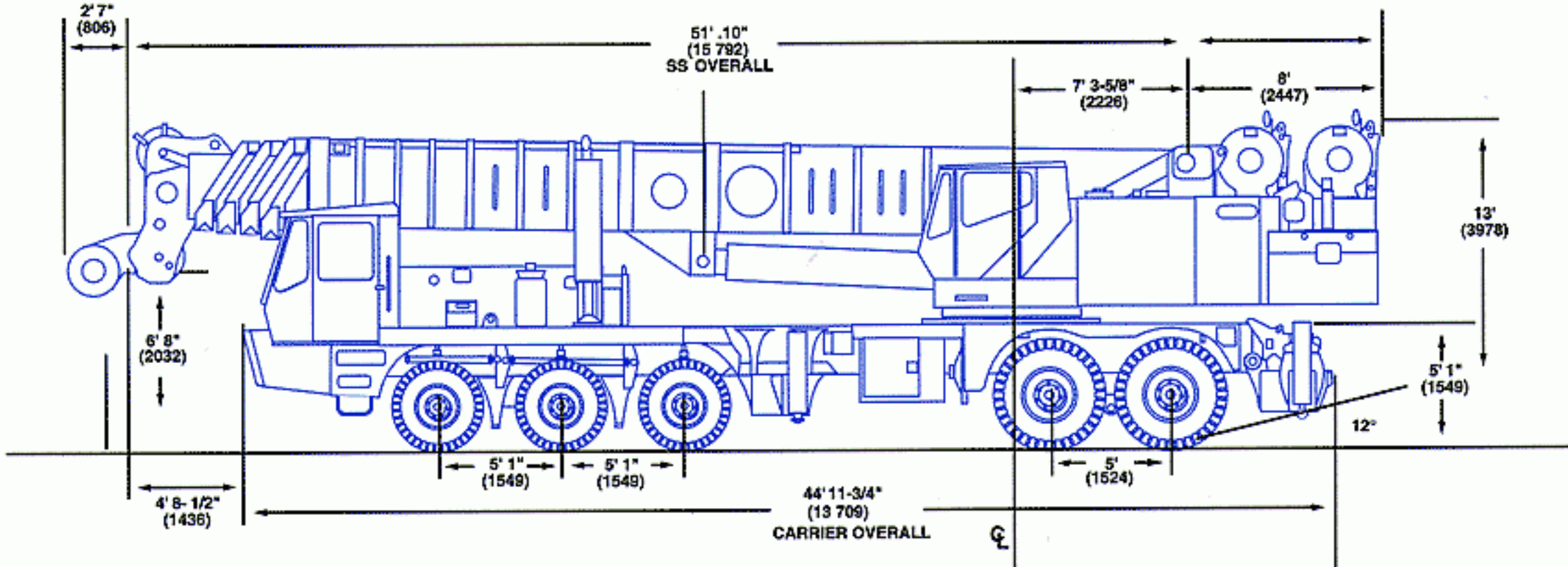
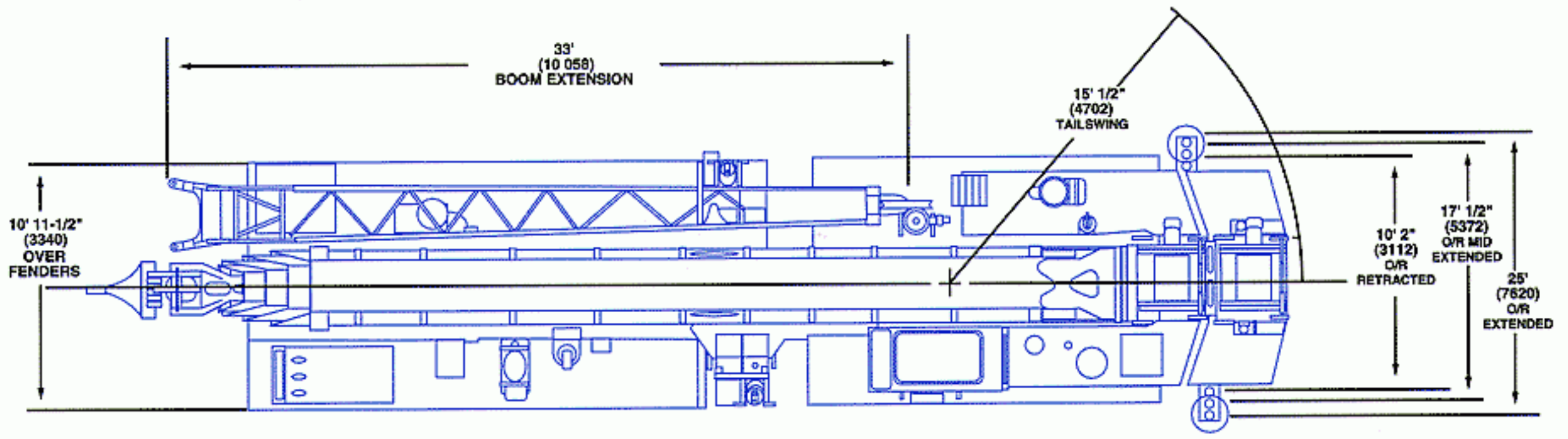

Axle Weight Distribution

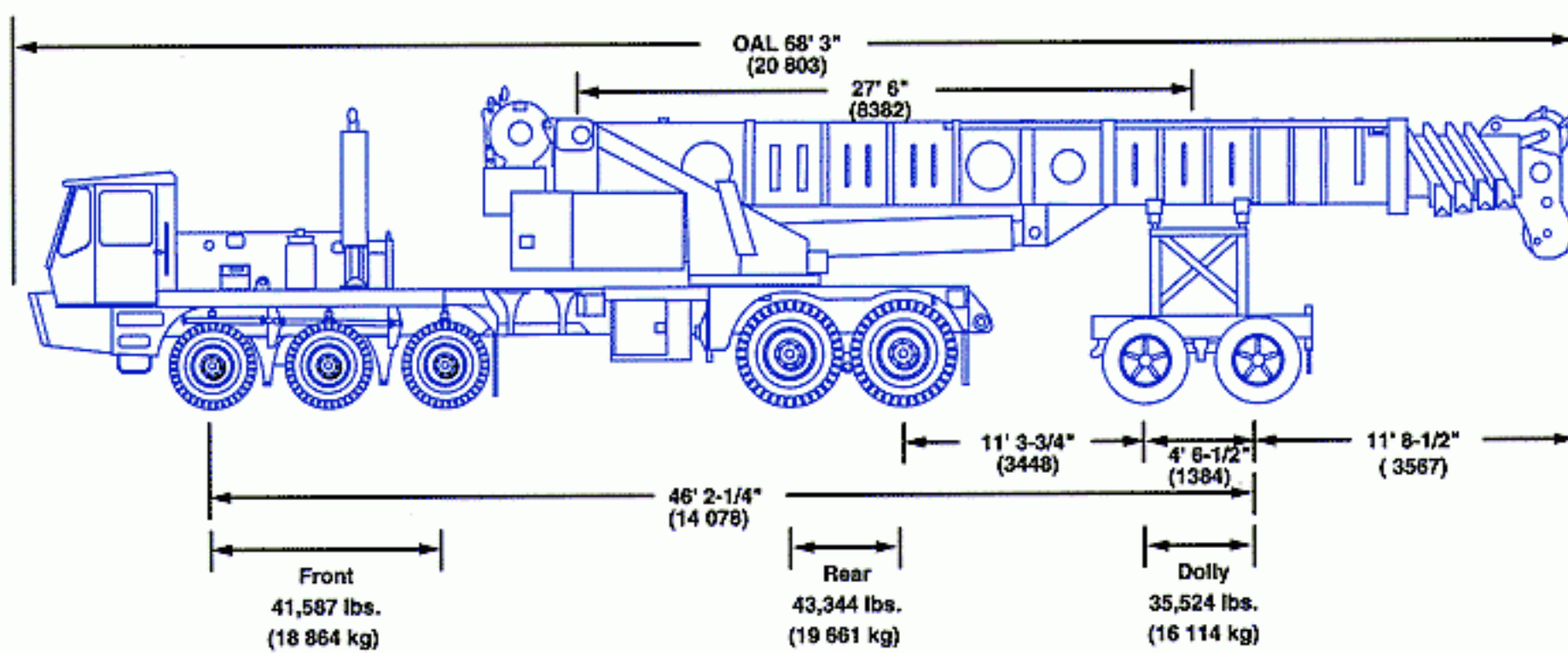

Machine equipped as follows:

- 160 ft. (48.7 m) full power boom
- Main hoist w/rope
- Full fuel & hydraulics
- Two axle dolly (5,730 lbs. [2599 kg])
- (6) 445/65R22.5 front tires
- (8) 14.00R25 rear tires

Components removed:

- Counterweight
- Front & rear O/R boxes
- Aux hoist w/rope
- Aux hoist structure
- Aux boom nose
- No block or ball
- 33 - 55 ft. (10.0 - 17.7 m)
- Tele swingaway

Working range



42-160 ft.
(12.8-48.7 m)



33-58 ft.
(10.0-17.7 m)



360°

FEET

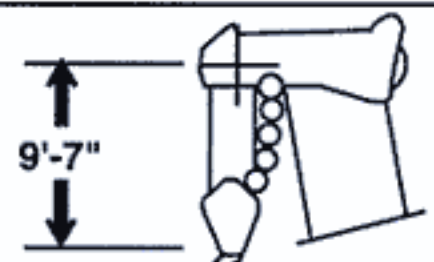
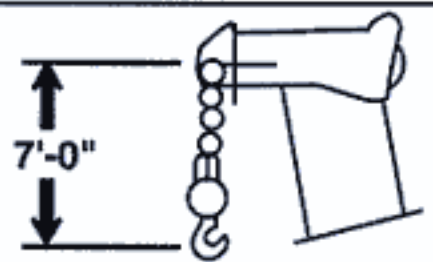
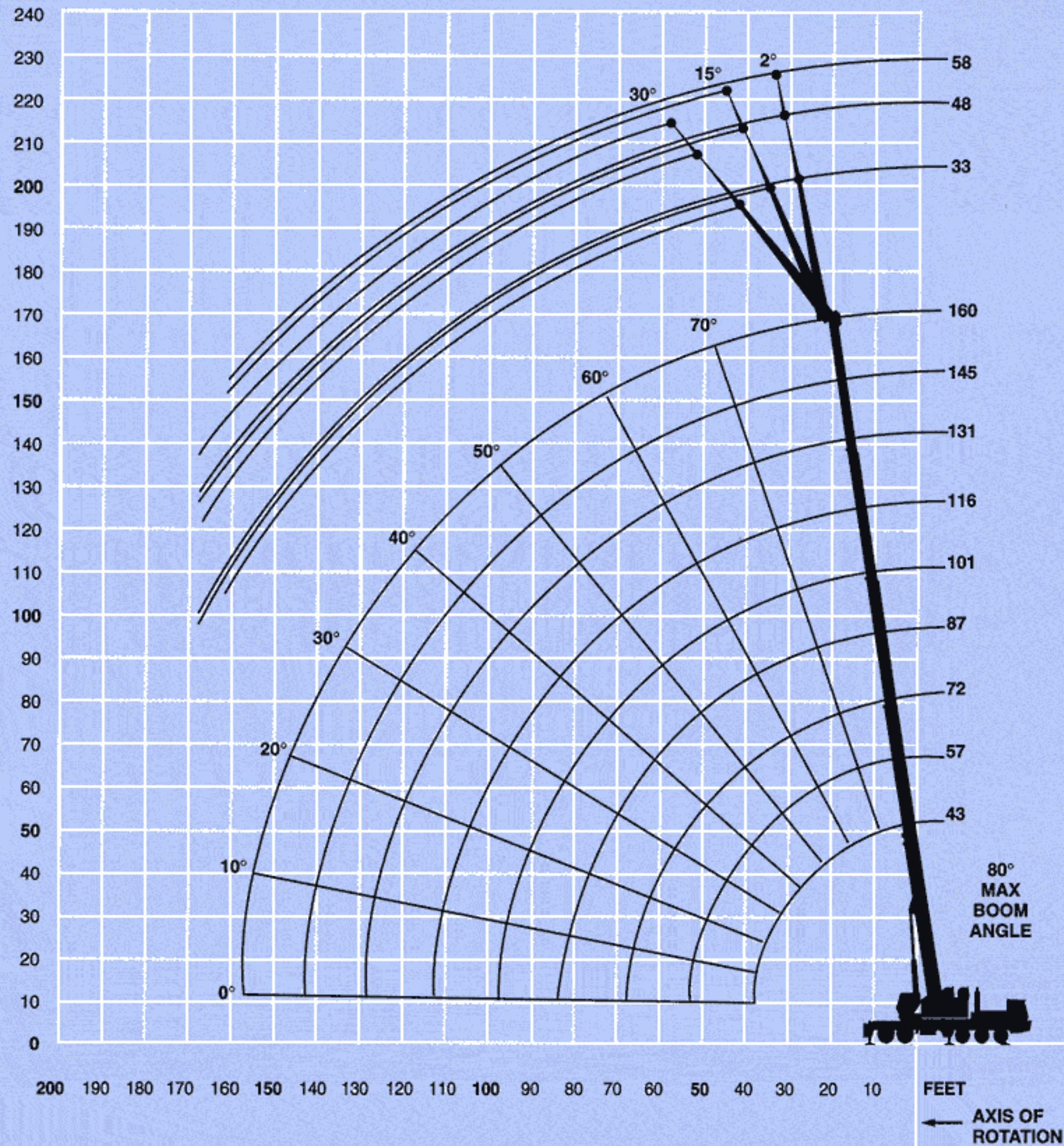

DIMENSIONS ARE FOR LARGEST GROVE FURNISHED HOOK BLOCK AND HEADACHEBALL, WITH ANTI-TWO BLOCK ACTIVATED.

Superstructure specifications

Boom

42 ft. - 160 ft. (12.8 m - 48.7 m) five-section full power boom with swingaround auxiliary boom nose.
Maximum Tip Height: 168 ft. (51.4 m).

Tele Boom Extension

33 ft. to 58 ft. (10 m to 17.7 m) telescopic lattice swingaway extension offsettable at 2°, 15° or 30°. Stows alongside base boom section.
Maximum Tip Height: 226 ft. (68.9 m).

*Optional Lattice Extension

28 ft. (8.5 m) base section combines with lattice inserts and point section for lengths of 74, 88, 102 and 116 ft. (22.6, 26.8, 31 and 35.3 m). All jib lengths are cable suspended and offset at 10°, 17° and 30°. Maximum tip height: 269 ft. (82 m).

Boom Elevation

One double acting hydraulic cylinder with integral holding valve provides elevation from - 3° to 80°.

Load Moment & Anti-Two Block System

Standard load moment and anti-two block system with audio-visual warning and control lever lockout to alert operator of impending two-block condition. Electronic display of boom angle, length, radius, tip height, relative load moment, maximum permissible load and actual load indication is provided.

Cab

Full vision, all steel cab with acoustical lining and tinted safety glass throughout. Deluxe with armrest mounted hydraulic joystick controls. Dash panel with gauges for all engine functions. Other standard features include: sliding side window, electric windshield wash/wipe, circulating air fan, opening skylight with electric skylight wiper, fire extinguisher and seat belt.

Swing

Planetary swing with foot applied wet brake. Spring applied, released hydraulically parking brake and plunger type, mechanical lock operated from cab. Maximum speed: 1.7 RPM.

Counterweight

Two piece: 11,000 lbs. (4990 kg) and 29,000 lbs. (13 154 kg). Total 40,000 lbs. (18 144 kg), installed/removed hydraulically.

Engine

Cummins 6CTA8.3 diesel, 6 cylinders, turbo-charged and after-cooled. 250 hp (186 kW) @ 2200 RPM.
Maximum torque: 716 ft. lbs. (1065 kg/m) @ 1500 RPM.

Fuel Tank Capacity

72 gallons (273 L)

HYDRAULIC SYSTEM

Six main gear pumps with a combined capacity of 215 GPM (814 lpm).

Three individual valve banks.

Return line type filter with full flow by-pass protection and service indicator. Replaceable cartridge with filtration rating of ISO 4406 Class 17/14.

326 gallon (1234 L) reservoir.

Remote mounted oil cooler with thermostatically controlled hydraulic motor driven fan.

System pressure test panel with ORFS type fittings.

HOIST SPECIFICATIONS

Main and Auxiliary Hoist

Variable displacement piston motor with pressure override. Planetary reduction with automatic spring-applied multi-disc brake. Grooved drum. Spring tensioned cable follower. Electronic hoist drum rotation indicator. Quick Removable Auxiliary Hoist Package.

Maximum Single Line Pull: 29,583 lbs.
(13 419 kg)

Maximum Single Line Speed:
(With Boost): 417 FPM
(127 m/min)

Maximum Permissible
Line Pull: 22,760 lbs.
(10 324 kg)

Rope Diameter: 1 in.
(25.4 mm)

Rope Length: 800 ft.
(244 m)

Maximum Rope Stowage: 1,000 ft.
(307 m)

Carrier specifications

Chassis

Triple box section, five-axle carrier fabricated from high-strength, low alloy steel. Removable outrigger housings.

Outrigger System

Four hydraulic telescoping single-stage double box beam outriggers with inverted jacks and integral holding valves. Quick release type outrigger floats 30.5 in. (775 mm) diameter. Standard fifth front stabilizer with 24 in. (635 mm) diameter float. Three position setting with fully extended, intermediate (50%) extended and fully retracted capacities. Intermediate extension is manually pinned. Maximum outrigger pad load: 157,028 lbs. (71 228 kg).

Outrigger Controls

Located in the superstructure cab and on both sides of the carrier, require two hand operation. Crane level indicator (sight bubble) adjacent.

Engine

Cummins N14-435E diesel, six cylinders, turbo-charged and after cooled. 855 cu. in. (14 L), 435 hp (325 kw) @ 1600 RPM, 350 hp (261 kw) @ 2100 RPM. Maximum torque 1,450 ft. lbs. (2102 kg/m) @ 1,200 RPM with engine brake and audio-visual engine distress system.

Fuel Tank Capacity

(1) 100 gallons (376 L)

Transmission

Fuller RT00-14613, 13 speeds forward, 3 reverse with Fuller AT 1202 2-speed auxiliary.

Drive

10 x 4 x 6

Axles

Front: Rockwell FL951 steering tridem.
Rear: Rockwell SPRC 1735 drive tandem with inter axle differential locks and no-spin differential in 4th axle.

Suspension

Front: Hydrogas.
Rear: Walking beam.

Tires

Front: 445/65R22.5 highway tread steel-belted tubeless radial singles.
Rear: 14.00R25 highway tread steel-belted tubeless radial duals.

Steering

Front axle mechanical steering with hydraulic power assist. Auxiliary ground driven steer pump.

Brakes

Full air split system operating on all wheels. Spring applied, air released parking brake acting on rear axles. Air dryer.

Cab

One man design, all steel fabricated with acoustical lining and tinted safety glass throughout. Deluxe fabric covered fully adjustable air ride seat. Complete driving controls and engine instrumentation including tachometer, speedometer, voltmeter, water temp., oil pressure, fuel level, air pressure gauge with A/V warning and engine high temp/low oil pressure/low coolant level A/V warning. Suspension pressure gauges. Other standard items include hot waterheater/defroster, electric windshield wash/wipe, fire extinguisher, seat belt and door and window locks.

Electrical System

Two 12 V - maintenance free batteries.
12 V start and lighting.

Lights

Full lighting package including turn indicators, head, tail, brake, and hazard warning lights.

Maximum Speed

55 mph (88 kph)

Gradeability (Theoretical)

71% (Theoretical)

Gross Vehicle Weight (Approximate)

BASIC STANDARD MACHINE
180,544 lbs. (81 895 kg).

Miscellaneous Standard Equipment

Aluminum fenders; lifting, towing and tie down lugs; permalube drive lines; hydraulic oil temperature light in superstructure cab.

Optional Equipment

- * 360° rotating beacon
- * Cab spotlight
- * Engine block heater
- * Hookblocks
- * Tool kit
- * Trailing boom kit
- * Trailing boom dolly
- * 51,000 lb. CWT package.

**Denotes optional equipment*



42 - 160 ft.
(12.8 - 48.7 m)



40,000 lbs.
(18 144 kg)
& Aux. Hoist



360°



85% Domestic (Pounds)

(Feet)	43	57	72	87	101	116	131	145	160
9	300,000								
10	270,000	141,000	*125,500						
12	204,000	141,000	125,500	*92,600					
15	179,000	141,000	125,500	92,600	*69,750				
20	135,000	133,500	115,500	86,550	69,350	*54,000	*43,400		
25	104,000	102,500	97,700	77,250	62,650	53,500	43,400	*32,050	
30	82,200	81,100	75,500	67,600	56,800	49,300	43,150	32,050	*25,350
35	<u>63,350</u>	65,800	65,950	58,400	51,150	45,100	39,850	32,050	25,350
40		54,400	54,600	51,300	46,400	41,400	36,600	31,900	25,050
45		<u>45,550</u>	45,800	45,450	42,450	37,750	34,000	30,800	23,250
50			38,800	39,600	38,700	34,700	31,350	29,000	22,100
60			<u>28,350</u>	<u>29,200</u>	<u>29,100</u>	<u>29,550</u>	27,050	24,700	20,050
70				21,450	21,250	22,750	<u>23,150</u>	21,400	16,650
80					15,200	16,700	18,100	<u>18,550</u>	14,450
90					10,650	12,100	13,550	14,950	12,800
100						8,620	10,000	11,400	<u>11,450</u>
110							7,190	8,560	9,920
120							4,880	6,230	7,570
130								4,280	5,600
140									3,940
150									2,530

*This capacity is based upon maximum obtainable boom angle.

+14 parts of line required to lift this capacity (using aux. boom nose).

A6-829-0113903



42 - 160 ft.
(12.8 - 48.7 m)



40,000 + 11,000 lbs.
(18 144 + 4990 kg)
& Aux. Hoist



360°



85% Domestic (Pounds)

(Feet)

(Feet)	43	57	72	87	101	116	131	145	160
10	300,000	141,000	*125,500						
12	204,000	141,000	125,500	*92,600					
15	179,000	141,000	125,500	92,600	*69,750				
20	135,000	133,500	115,500	86,550	69,350	*54,000	*43,400		
25	104,000	102,500	97,700	77,250	62,650	53,500	43,400	*32,050	
30	82,200	81,100	75,500	67,600	56,800	49,300	43,150	32,050	*25,350
35	<u>63,350</u>	65,800	65,950	58,400	51,150	45,100	39,850	32,050	25,350
40		54,400	54,600	51,300	46,400	41,400	36,600	31,900	25,050
45		<u>45,550</u>	45,800	45,450	42,450	37,750	34,000	30,800	23,250
50			38,800	39,600	38,700	34,700	31,350	29,000	22,100
60			<u>28,350</u>	29,200	29,100	29,550	27,050	24,700	20,050
70				<u>21,750</u>	21,750	23,550	23,150	21,400	16,650
80					16,200	18,050	19,150	18,550	14,450
90					<u>11,850</u>	13,750	15,100	15,500	12,800
100						<u>10,250</u>	11,700	12,750	11,450
110							8,840	9,970	10,350
120							<u>6,370</u>	7,550	8,480
130								<u>5,490</u>	6,420
140									4,660
150									<u>3,140</u>

*This capacity is based upon maximum obtainable boom angle.



42 - 160 ft.
(12.8 - 48.7 m)



11,000 lbs.
(4989 kg)
& Aux. Hoist



360°



85% Domestic (Pounds)

(Feet)	43	57	72	87	101	116	131	145	160
10	243,000	141,000	*125,500						
12	204,000	141,000	125,500	*92,600					
15	161,500	141,000	125,500	92,600	*69,750				
20	115,000	114,000	114,000	86,550	69,350	*54,000	*43,400		
25	86,650	85,400	85,550	77,250	62,650	53,500	43,400	*32,050	
30	67,850	66,700	66,850	67,600	56,800	49,300	43,150	32,050	*25,350
35	<u>54,400</u>	<u>53,550</u>	<u>53,700</u>	<u>54,500</u>	<u>51,150</u>	45,100	39,850	32,050	25,350
40		<u>42,850</u>	<u>42,550</u>	<u>42,100</u>	<u>43,000</u>	<u>41,400</u>	36,600	31,900	25,050
45		32,800	32,700	32,850	33,200	35,100	<u>34,000</u>	30,800	23,250
50			25,400	26,100	25,950	27,800	29,700	<u>29,000</u>	22,100
60			15,300	16,850	16,100	17,850	19,600	21,350	<u>20,050</u>
70				10,650	9,700	11,350	13,000	14,700	16,400
80					5,070	6,770	8,390	10,000	11,650
90					1,630	3,290	4,950	6,540	8,150
100							2,240	3,860	5,430
110								1,680	3,270
120									1,470

*This capacity is based upon maximum obtainable boom angle.



42 - 160 ft.
(12.8 - 48.7 m)

Zero
Counterweight

360°



85% Domestic (Pounds)

(Feet)	43	57	72	87	101	116	131	145	160
10	225,500	141,000	*125,500						
12	190,500	141,000	125,500	*92,600					
15	148,500	141,000	125,500	92,600	*69,750				
20	103,500	102,000	102,000	86,550	69,350	*54,000	*43,400		
25	77,450	76,200	<u>76,350</u>	<u>77,150</u>	62,650	53,500	43,400	*32,050	
30	<u>60,250</u>	<u>59,100</u>	58,750	58,800	<u>56,800</u>	<u>49,300</u>	43,150	32,050	*25,350
35	<u>42,700</u>	<u>42,350</u>	41,450	41,750	42,500	44,550	<u>39,850</u>	32,050	25,350
40		30,950	30,450	30,900	31,150	33,000	34,900	<u>31,900</u>	25,050
45		22,950	22,850	23,400	23,250	25,000	26,800	<u>28,550</u>	23,250
50			17,200	17,900	17,500	19,150	20,800	22,500	<u>22,100</u>
60			9,360	10,350	9,610	11,100	12,650	14,250	<u>15,800</u>
70				5,340	4,450	5,890	7,360	8,840	10,300
80						2,210	3,610	5,040	6,470
90								2,210	3,610
100									1,400

*This capacity is based upon maximum obtainable boom angle.

A6-829-013905



42 - 160 ft.
(12.8 - 48.7 m)

Zero Counterweight
& Aux. Hoist

360°



85% Domestic (Pounds)

(Feet)	43	57	72	87	101	116	131	145	160
10	235,500	141,000	*125,500						
12	195,000	141,000	125,500	*92,600					
15	152,500	141,000	125,500	92,600	*69,750				
20	107,000	105,500	105,500	86,550	69,350	*54,000	*43,400		
25	80,050	78,800	78,950	77,250	62,650	53,500	43,400		
30	62,400	<u>61,250</u>	<u>61,400</u>	<u>62,200</u>	<u>56,800</u>	49,300	43,150	32,050	*25,350
35	<u>49,450</u>	<u>46,250</u>	<u>44,750</u>	<u>45,750</u>	<u>45,500</u>	<u>45,100</u>	39,850	32,050	25,350
40		34,650	33,450	34,150	33,700	35,700	<u>36,600</u>	31,900	25,050
45		26,500	25,650	26,150	25,550	27,350	29,200	<u>30,800</u>	23,250
50			19,850	20,250	19,600	21,250	23,000	24,750	<u>22,100</u>
60			11,800	12,150	11,400	12,950	14,500	16,050	<u>17,650</u>
70				6,780	6,090	7,500	8,950	10,400	11,850
80					2,220	3,680	5,040	6,420	7,820
90							2,140	3,470	4,810
100								1,190	2,490

*This capacity is based upon maximum obtainable boom angle.

A6-829-14098



116 ft.
(35.4 m)



33 - 58 ft.
(10.0 - 17.7 m)



40,000 lbs.
(18 144 kg)
& Aux. Hoist



360°



85% Domestic (Pounds)

(Feet)	33 ft. LENGTH (Fully Retracted)			48 ft. LENGTH			58 ft. LENGTH (Fully Extended)		
	2° Offset	15° Offset	30° Offset	2° Offset	15° Offset	30° Offset	2° Offset	15° Offset	30° Offset
25	*28,600								
30	28,600	*23,500		20,600			*17,500		
35	27,300	23,500	*14,400	20,600			17,500		
40	26,900	23,100	14,400	19,500	13,400		16,400		
45	26,100	22,400	14,400	18,500	13,400		15,800	10,600	
50	23,000	20,800	14,000	17,400	13,000	8,370	14,700	10,600	*6,610
60	20,100	19,000	13,200	15,700	11,900	8,100	13,400	9,830	6,610
70	17,400	17,200	12,400	14,000	10,500	7,570	12,100	9,000	6,310
80	15,200	15,500	11,800	13,000	9,900	7,100	10,900	8,300	5,890
90	13,300	13,600	11,100	12,000	9,200	6,770	9,800	7,720	5,560
100	<u>11,600</u>	<u>11,900</u>	<u>10,500</u>	<u>11,200</u>	8,430	6,470	8,950	7,140	5,280
110	8,790	9,320	9,930	9,350	7,870	6,200	8,300	6,600	5,070
120	6,460	6,890	7,400	6,780	<u>7,400</u>	5,920	<u>7,590</u>	6,260	4,830
130	4,510	4,880		4,650	5,930	<u>5,750</u>	6,450	<u>5,860</u>	4,670
140	2,880			2,850	4,080	<u>5,490</u>	4,690	<u>5,400</u>	<u>4,520</u>
150				1,320	2,490		3,190	3,720	4,320
160							1,900	2,260	

*This capacity is based upon maximum boom angle.

A6-829-013907A



131 ft.
(39.9 m)



33 - 58 ft.
(10.0 - 17.7 m)



40,000 lbs.
(18 144 kg)
& Aux. Hoist



360°



85% Domestic (Pounds)

(Feet)	33 ft. LENGTH (Fully Retracted)			48 ft. LENGTH			58 ft. LENGTH (Fully Extended)		
	2° Offset	15° Offset	30° Offset	2° Offset	15° Offset	30° Offset	2° Offset	15° Offset	30° Offset
30	25,600								
35	25,600	*22,900		18,600			*15,200		
40	24,400	22,900	*14,400	18,600			15,200		
45	23,700	22,100	14,400	17,800	13,300		15,200		
50	22,900	21,300	14,300	17,100	13,300	*8,210	14,200	10,400	
60	18,800	18,800	13,400	15,500	12,000	8,210	13,100	10,100	*6,390
70	16,400	16,700	12,600	14,100	11,100	7,720	11,600	9,220	6,300
80	14,200	14,600	12,000	12,700	10,200	7,330	10,500	8,490	6,020
90	12,400	12,800	11,300	11,400	9,580	7,000	9,410	7,890	5,670
100	<u>10,900</u>	11,200	10,800	10,200	9,040	6,660	8,540	7,300	5,390
110	8,990	<u>9,740</u>	<u>10,000</u>	9,360	8,290	6,330	7,630	6,910	5,180
120	6,620	7,270	8,030	<u>8,380</u>	<u>7,820</u>	6,050	6,920	6,470	4,910
130	4,650	5,200	5,850	6,560	7,220	5,820	6,250	6,100	4,870
140	2,990	3,460		4,880	5,420	<u>5,650</u>	<u>5,620</u>	<u>5,700</u>	4,610
150	1,570	1,970		3,440	3,880	4,400	4,230	4,640	<u>4,440</u>
160				2,190	2,550		2,950	3,220	3,550
170				1,100			1,830	1,990	

*This capacity is based upon maximum boom angle.

A6-829-14121



160 ft.
(48.7 m)



33 - 58 ft.
(10.0 - 17.7 m)



40,000 lbs.
(18 144 kg)
& Aux. Hoist



360°



85% Domestic (Pounds)

33 ft. LENGTH (Fully Retracted)

48 ft. LENGTH

58 ft. LENGTH (Fully Extended)

(Feet)	2° Offset	15° Offset	30° Offset	2° Offset	15° Offset	30° Offset	2° Offset	15° Offset	30° Offset
45	11,700			*8,370			*6,280		
50	10,800	*10,600	*10,400	8,040			6,280		
60	9,690	9,490	9,910	7,190	7,080	*7,050	5,760	*5,510	
70	8,580	8,480	8,790	6,360	6,250	6,690	5,020	4,990	*5,070
80	7,570	7,510	7,840	5,630	5,520	5,970	4,440	4,350	4,810
90	6,660	6,680	7,010	4,970	4,860	5,300	3,790	3,870	4,140
100	5,890	5,890	6,210	4,290	4,220	4,660	3,300	3,350	3,740
110	5,150	5,150	5,550	3,670	3,730	4,190	2,860	2,900	3,290
120	4,550	4,550	4,940	3,160	3,300	3,660	2,390	2,520	2,900
130	3,990	3,990	4,300	2,800	2,830	3,220	2,030	2,120	2,570
140	3,450	3,490	3,820	2,400	2,460	2,840	1,610	1,800	2,230
150	2,790	3,060	3,350	1,990	2,060	2,440	1,290	1,440	1,900
160	<u>1,610</u>	<u>1,890</u>	<u>2,210</u>	1,700	1,650	2,120	<u>1,020</u>	<u>1,190</u>	1,550
170				<u>1,190</u>	<u>1,420</u>	<u>1,780</u>			<u>1,300</u>

*This capacity is based upon maximum boom angle.

Working range



42-160 ft.
(12.8-48.7 m)



74-116 ft.
(22.6-35.3 m)



360°

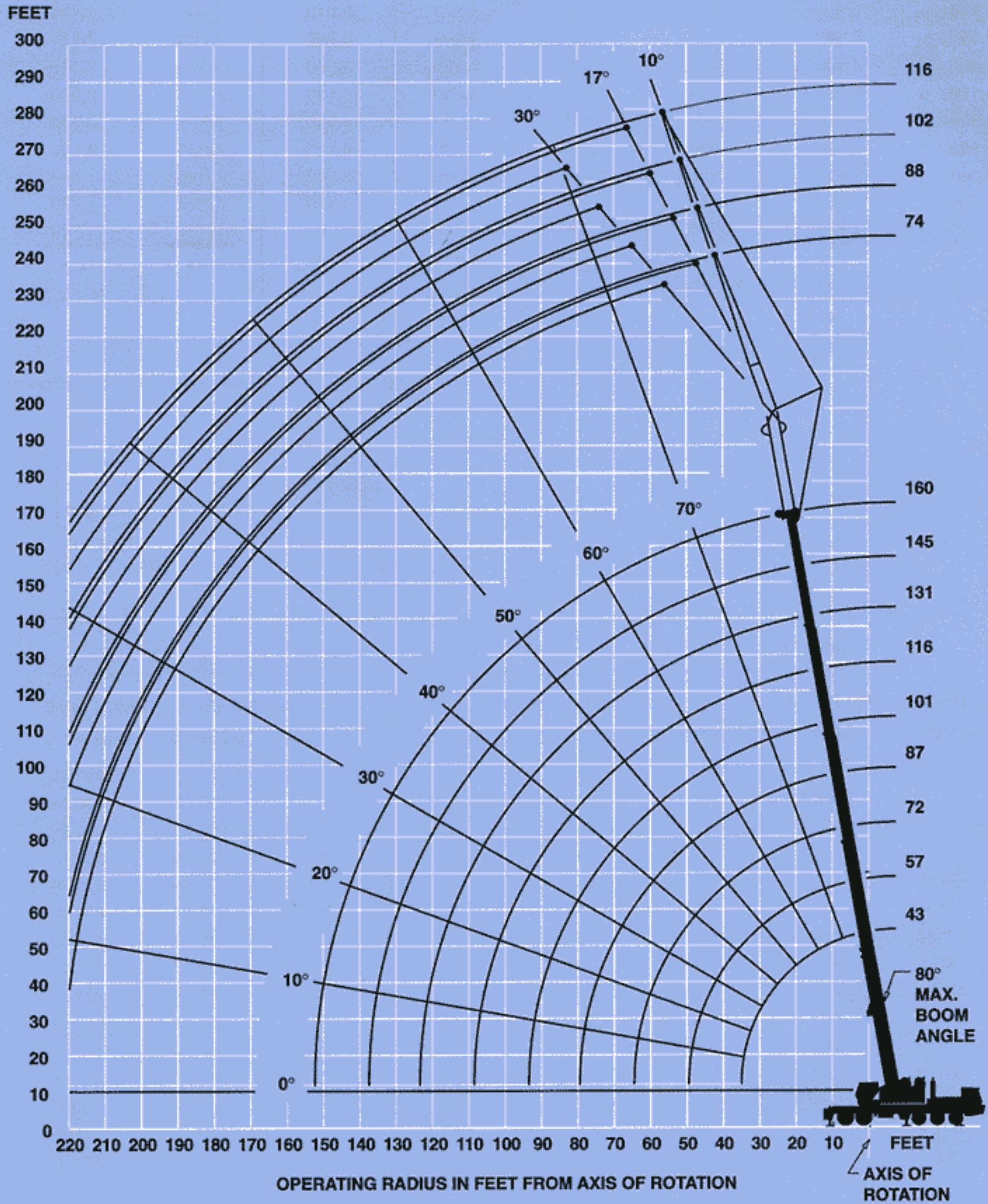



131 ft.
(39.9 m)



74 - 116 ft.
(22.6 - 35.4 m)



40,000 lbs.
(18 144 kg)
& Aux. Hoist



360°



85% Domestic (Pounds)

74 ft. JIB (28 ft. ext. + 46 ft. jib)

10° Offset

17° Offset

30° Offset

	Rad.Ref. (ft.)*	Cap. lbs.**	Rad.Ref. (ft.)*	Cap. lbs.**	Rad.Ref. (ft.)*	Cap. lbs.**
80	46.8	9,000	51.9	8,820	60.4	8,310
77.5	55.6	7,920	60.6	7,830	68.8	7,430
75	64.3	7,890	69.1	7,610	77	7,100
72.5	72.8	7,850	77.5	7,250	85.1	6,830
70	81.2	7,720	85.7	6,990	96.8	6,640
67.5	89.4	7,060	93.8	6,750	92.9	6,420
65	97.3	6,500	101.6	6,280	100.6	6,220
62.5	105.1	5,950	109.1	5,840	108	5,840
60	112.6	5,510	116.5	5,400	115.2	5,360
55	126.9	4,740	130.4	4,630	122.1	4,480
50	140.1	3,660	143.1	3,440	135.2	3,330
45	152.1	2,580	154.7	2,450	157.7	2,380
40	162.8	1,740	164.9	1,680	167.1	1,650

88 ft. JIB (28 ft. ext. + 60 ft. jib)

10° Offset

17° Offset

30° Offset

	Rad. Ref. (ft.)*	Cap. lbs.**	Rad. Ref. (ft.)*	Cap. lbs.**	Rad. Ref. (ft.)*	Cap. lbs.**
	51.7	7,080	58.7	6,460	70	5,930
	61.3	6,060	68	5,670	78.8	4,870
	70.7	6,020	77.1	5,380	87.4	4,720
	79.9	5,950	86.1	5,140	95.8	4,590
	88.9	5,670	94.8	4,960	104	4,450
	97.7	5,160	103.3	4,760	112	4,340
	106.3	4,670	111.7	4,540	119.7	4,260
	114.6	4,280	119.7	4,190	127.2	4,170
	122.7	3,880	127.5	3,840	134.4	3,840
	138	3,260	142.2	3,200	148	3,200
	152	2,690	155.7	2,580	160.2	2,560
	164.7	1,790	167.8	1,680	171.2	1,650

102 ft. JIB (28 ft. ext. + 74 ft. jib)

10° Offset

17° Offset

30° Offset

	Rad.Ref. (ft.)*	Cap. lbs.**	Rad.Ref. (ft.)*	Cap. lbs.**	Rad.Ref. (ft.)*	Cap. lbs.**
80	58.8	5,270	67.6	4,870	82	3,510
77.5	68.8	4,810	77.4	4,280	91.2	3,370
75	78.7	4,540	87	4,260	100.2	3,240
72.5	88.4	4,100	96.4	3,920	108.9	3,110
70	97.9	3,700	105.6	3,480	117.4	2,950
67.5	107.2	3,310	114.5	3,130	125.7	2,820
65	116.2	2,910	123.2	2,760	133.7	2,730
62.5	125	2,560	131.6	2,470	141.4	2,470
60	133.4	2,270	139.7	2,210	148.8	2,210
55	149.5	1,760	155	1,720	162.7	1,720
50	164.2	1,320	169	1,320	175.2	1,320

116 ft. JIB (28 ft. ext. + 88 ft. jib)

10° Offset

17° Offset

30° Offset

	Rad.Ref. (ft.)*	Cap. lbs.**	Rad.Ref. (ft.)*	Cap. lbs.**	Rad.Ref. (ft.)*	Cap. lbs.**
	65.2	3,660	75.2	3,440	91.4	3,020
	75.8	3,000	85.5	2,780	101	2,380
	86.3	2,780	95.6	2,580	110.5	2,250
	96.5	2,490	105.5	2,320	119.6	2,090
	106.6	2,140	115.2	1,980	128.6	1,980
	116.3	1,830	124.6	1,700	137.2	1,700
	125.8	1,520	133.7	1,410	145.6	1,410
	135.1	1,260	142.6	1,150	153.6	1,150
	144	1,010				

*Reference radius refers to fully extended boom and appropriate jib length.

**Capacities at loaded main boom angle.



145 ft.
(44.2 m)



74 - 116 ft.
(22.6 - 35.4 m)



40,000 lbs.
(18 144 kg)
& Aux. Hoist



360°



85% Domestic (Pounds)

74 ft. JIB (28 ft. ext. + 46 ft. jib)

	10° Offset		17° Offset		30° Offset	
	Rad.Ref. (ft.)*	Cap. lbs.**	Rad.Ref. (ft.)*	Cap. lbs.**	Rad.Ref. (ft.)*	Cap. lbs.**
80	49.7	6,990	55.5	6,720	64.8	6,390
77.5	59.3	5,930	64.8	5,890	73.7	5,840
75	68.7	5,730	74	5,450	82.4	5,230
72.5	78	5,120	83	4,890	90.9	4,740
70	87	4,560	91.8	4,340	99.3	4,300
67.5	95.9	4,080	100.4	3,900	107.4	3,860
65	104.5	3,640	108.8	3,460	115.3	3,460
62.5	112.9	3,200	117	3,090	122.9	3,090
60	121	2,800	124.9	2,760	130.3	2,760
55	136.5	2,210	139.8	2,210	144.3	2,210

88 ft. JIB (28 ft. ext. + 60 ft. jib)

	10° Offset		17° Offset		30° Offset	
	Rad.Ref. (ft.)*	Cap. lbs.**	Rad.Ref. (ft.)*	Cap. lbs.**	Rad.Ref. (ft.)*	Cap. lbs.**
80	56.2	5,070	63.7	4,850	75.3	4,520
77.5	66.2	4,450	73.5	4,230	84.6	4,080
75	76	3,920	83	3,700	93.7	3,640
72.5	85.6	3,460	92.3	3,260	102.6	3,220
70	95	3,040	101.5	2,870	111.3	2,820
67.5	104.2	2,620	110.4	2,510	119.7	2,490
65	113.2	2,250	119.2	2,160	127.9	2,160
62.5	121.9	1,950	127.6	1,850	135.8	1,850
60	130.4	1,610	135.8	1,540	143.5	1,540
55	146.5	1,100	151.3	1,060		

102 ft. JIB (28 ft. ext. + 74 ft. jib)

	10° Offset		17° Offset		30° Offset	
	Rad.Ref. (ft.)*	Cap. lbs.**	Rad.Ref. (ft.)*	Cap. lbs.**	Rad.Ref. (ft.)*	Cap. lbs.**
80	63.1	3,220	71.4	3,000	84.6	2,870
77.5	73.9	2,760	81.8	2,540	94.4	2,430
75	84.5	2,340	92.1	2,160	103.9	2,100
72.5	94.9	1,940	102.1	1,810	113.2	1,740
70	105.1	1,590	112	1,460	122.3	1,430
67.5	115.1	1,240	121.5	1,120	131.1	1,120

116 ft. JIB (28 ft. ext. + 88 ft. jib)

	10° Offset		17° Offset		30° Offset	
	Rad.Ref. (ft.)*	Cap. lbs.**	Rad.Ref. (ft.)*	Cap. lbs.**	Rad.Ref. (ft.)*	Cap. lbs.**
80	72	1,810	82	1,610	98.2	1,480
77.5	82.5	1,430	93.5	1,260	108.2	1,150
75	88.5	1,080				

*Reference radius refers to fully extended boom and appropriate jib length.

**Capacities at loaded main boom angle.

A6-829-014571A



160 ft.
(48.8 m)

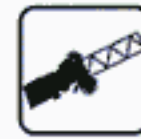

74 - 116 ft.
(22.6 - 35.4 m)



40,000 lbs.
(18 144 kg)
& Aux. Hoist



360°



85% Domestic (Pounds)

74 ft. JIB (28 ft. ext. + 46 ft. jib)

	10° Offset		17° Offset		30° Offset	
	Rad.Ref. (ft.)*	Cap. lbs.**	Rad.Ref. (ft.)*	Cap. lbs.**	Rad.Ref. (ft.)*	Cap. lbs.**
80	53.7	4,410	58.3	4,080	69	3,860
77.5	64	3,750	68.5	3,530	78.7	3,420
75	74	3,200	78.5	2,980	88.2	2,910
72.5	83.9	2,690	88.3	2,540	97.5	2,470
70	93.6	2,210	97.9	2,090	106.5	2,090
67.5	103.1	1,810	107.2	1,700	115.4	1,700
65	112.3	1,430	116.3	1,370	123.9	1,370
62.5	121.3	1,150	125.2	1,100	132.2	1,100

88 ft. JIB (28 ft. ext. + 60 ft. jib)

	10° Offset		17° Offset		30° Offset	
	Rad.Ref. (ft.)*	Cap. lbs.**	Rad.Ref. (ft.)*	Cap. lbs.**	Rad.Ref. (ft.)*	Cap. lbs.**
80	59.4	2,820	66.7	2,650	78.7	2,470
77.5	70.3	2,320	77.4	2,160	88.9	2,070
75	81	1,900	87.8	1,720	98.8	1,650
72.5	91.5	1,480	98.1	1,320	108.6	1,300
70	101.8	1,100				

*Reference radius refers to fully extended boom and appropriate jib length.

**Capacities at loaded main boom angle.

A6-829-014572



43- 160 ft.
(12.8 m - 48.7 m)

Over Rear



85% Domestic (Pounds)

(Feet)	1 MPH Capacity	1 MPH Capacity	1 MPH Capacity	2.5 MPH Capacity	2.5 MPH Capacity
	51,000 lb. Counterweight	40,000 lb. Counterweight	11,000 lb. Counterweight	No Counterweight With Aux. Hoist	No Counterweight No Aux. Hoist
10	83,950 (b)	85,500 (a)	75,850 (a)	58,700 (b)	49,200 (b)
12	82,700 (b)	85,500 (a)	75,850 (a)	57,900 (b)	49,200 (b)
15	78,300 (c)	80,650 (a)	62,900 (a)	50,500 (b)	45,350 (b)
20	69,200 (d)	67,000 (b)	43,950 (b)	35,250 (c)	31,850 (c)
25	55,900 (d)	49,500 (b)	31,700 (c)	25,000 (c)	22,350 (d)
30	41,900 (d)	36,750 (c)	22,300 (c)	16,300 (d)	13,650 (d)
35	32,200 (e)	27,900 (c)	15,500 (d)	9,810 (e)	7,570 (d)
40	25,200 (e)	21,500 (d)	10,000 (e)	5,090 (e)	3,160 (d)
45	19,900 (e)	16,650 (e)	5,830 (e)	1,520 (e)	
50	15,750 (e)	12,700 (e)	2,560 (e)		
55	12,600 (e)	9,360 (e)			
60	8,950 (e)	5,970 (e)			
65	5,820 (e)	3,080 (e)			
70	3,130 (e)				