

Grove GMK5115

Product Guide



Features

- 100 t (115 USt) capacity
- 11,7 m - 60 m (38 ft - 197 ft) seven-section full power boom
- 10 m - 17 m (33 ft - 56 ft) bi-fold lattice swingaway, hydraulic luffing or manual offset
- 3,3 m (11 ft) three-sheave heavy duty jib, hydraulic luffing, integrated in swingaway
- 27100 kg (59,700 lb) counterweight with hydraulic removal system
- MEGATRAK™ independent hydro-pneumatic suspension



Features

MEGATRAK™

The MEGATRAK™ suspension system is the best off road driveline available on the market today. The system's versatility and performance allows the GMK5115 to operate as a true all-terrain crane. The MEGATRAK™ independent suspension and all-wheel steer system allows wheels to remain on the ground at all times so stresses and weight are not continually transferred between axles. MEGATRAK™ provides true ground clearance where others just raise the chassis.

Other benefits of the MEGATRAK™ system are:

- A reliable suspension system
- Excellent job site maneuverability with all-wheel steering
- Commonality among almost all models
- A driveline that remains aligned at all times
- A steering linkage system that is protected against damage
- Constant tire contact for equal tire wear
- Reduced maintenance



CraneSTAR

CraneSTAR is an exclusive and innovative crane asset management system that helps improve your profitability and reduce costs by remotely monitoring critical crane data. Visit www.cranestar.com for more information.



TWIN-LOCK™

Boom pinning mechanism automatically pins the sections in position using two horizontal pins.

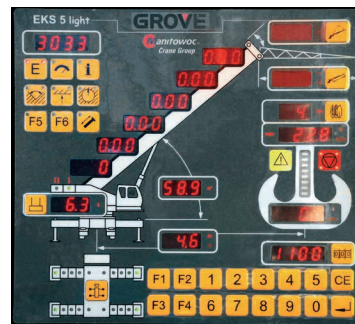

EKS 5 Light

Monitoring the lifting condition of the crane at all times EKS works together with, but independently of the ECOS as a complete command and control system or separately as a load moment indicator.

ECOS

Electronic Crane Operating System - ECOS enables control of the entire crane's principle operations. Simple programming eases lift planning and a supply of essential information allows full concentration on the lift itself.



Contents

Specifications	4
Dimensions	7
Counterweight	8
Weight proposal	9
Working range (main boom)	10
Load charts (main boom)	11
Working range (swingaway and inserts)	13
Load charts (hydraulically offsettable swingaway)	14
Working range (heavy duty jib)	17
Load charts (heavy duty jib)	18
Symbols glossary	20

Specifications

Superstructure



Boom

11,7 m - 60 m (38 ft - 197 ft) seven-section, full power boom with patented TWIN-LOCK™ boom pinning system.

Maximum tip height: 63 m (207 ft).



Boom nose

Seven nylatron sheaves, mounted on heavy duty tapered roller bearings with removable pin-type rope guards. Quick reeve boom nose. Removable auxiliary boom nose with removable pin type rope guard.



Boom elevation

Single lift cylinder with safety valve provides boom angle from -1.5° to +82°.



Hydraulic offsettable lattice extension

10 m - 17 m (33 ft - 56 ft) bi-fold lattice swingaway extension **hydraulically offsettable** and luffing under load: 0° - 40°. Controlled from the crane cab. Maximum tip height: 80 m (263 ft)



*Offsettable lattice extension

10 m - 17 m (33 ft - 56 ft) bi-fold lattice swingaway extension manually offset: 0°, 20° or 40°. Maximum tip height: 80 m (263 ft)



Lattice extension inserts

One 5 m (16 ft) insert for use with lattice swingaway extension. Increases extension length to 22 m (72 ft). Maximum tip height: 85 m (279 ft)



Load moment and anti-two block system

Load moment and anti-two block system with audio/visual warning and control lever lockout provides electronic display of boom angle, length, radius, tip height, relative load moment, maximum permissible load, load indication and warning of impending two-block condition.



Cab

All aluminum construction cab with acoustical lining, tinted safety glass, adjustable operator's seat with suspension, opening windows in side and cab rear, hinged front window with wiper, sunvisor and window shade. Other features include hot water heater, armrest integrated crane controls, and ergonomically arranged instrumentation.



Crane control system

Full electronic control of all crane movements using electrical control levers with automatic reset to zero. Controls are integrated with the LMI and engine management system by CAN-BUS. ECOS system with graphic display.



Swing

Two planetary gears with axial piston motors. Infinitely variable to 1.9 rpm. Holding and service brake.



Counterweight

27 100 kg (59,700 lb) consisting of various sections with hydraulic installation/removal system. Controlled from the superstructure cab.



Engine

Mercedes-Benz OM 904 LA diesel, 4 cylinders, water cooled, turbocharged with 129 kW (148 bhp) at 2200 rpm.

Max torque: 580 Nm (428 ft/lb) at 1200 rpm.

Engine emission: EUROMOT/EPA/CARB Tier III (non-road).



Hydraulic system

2 separate circuits, 1 axial piston variable displacement pump (load sensing) with electronic power limiting control and 1 gear pump for swing.

Dual thermostatically controlled oil coolers keep oil at optimum operating temperature.

Tank capacity: 600 L (158 gal)

Specifications

Superstructure continued

Hoist

Main and auxiliary hoists are powered by axial piston motor with planetary gear and brake. “Thumb-thumper” hoist drum rotation indicator alerts operator of hoist movement.

	Main	Auxiliary
Line length:	255 m (837 ft)	255 m (837 ft)
Rope diameter:	17 mm	17 mm
Line speed:	120 m/min (394 ft/min)	120 m/min (394 ft/min)
Line pull:	56 kN (12,589 lb)	56 kN (12,589 lb)

*Optional hookblocks

Lifting capacity	Sheaves	Weight	Parts of line	Possible load with the crane*
100 t (110 USt)	7	1000 kg (2200 lb)	2-15	82 t (90 USt)
63 t (70 USt)	5	750 kg (1653 lb)	2-11	61 t (67 USt)
40 t (44 USt)	3	550 kg (1213 lb)	1-7	39 t (43 USt)
20 t (22 USt)	1	300 kg (661 lb)	1-3	17 t (18.7 USt)
8 t (8.8 USt)	H/B	200 kg (440 lb)	1	5,7 t (6.3 USt)

* varies depending on national regulations

Electrical system

24V system with three phase alternator, 28V/80A. Two batteries, 12V/170 Ah.

*Optional equipment

- 3,3 m (10.8 ft) three-sheave integrated heavy duty jib
- Work light, mounted on top of base section
- Cab controlled work lights mounted to top of base section
- Stainless steel exhaust system with spark arrestor in lieu of standard
- Engine independent diesel cab heater, also serves as engine preheater including 24-hour timer
- Stereo/radio CD player
- Outrigger pad load indicator with readout both in superstructure cab and carrier

- Air conditioning
- Working range limiter
- Boom mounted aircraft warning light
- Drive and steer control for superstructure
- EKS5 with graphic display

Carrier

Chassis

Box type, torsion resistant frame is fabricated from high strength steel.

Outrigger system

Four hydraulic single stage outrigger beams with vertical cylinders and outrigger pads, 600 mm (23.6 in) square. Outriggers can be set in five positions:

Full:	7,5 m (24.6 ft)
Partial:	6,7 m (22.0 ft)
	5,9 m (19.4 ft)
	5,1 m (16.7 ft)

Retracted: 2,5 m (8.2 ft)

Independent horizontal and vertical movement controlled from each side of carrier. Electronic crane level indicators. Outrigger monitoring system included.

Engine

Mercedes-Benz OM 502 LA eight cylinder, water cooled, turbo-charged, with 375 kW (503 bhp) at 1800 rpm. Max. torque 2400 Nm (1770 ft/lb) at 1300 rpm.

Engine emissions: EUROMOT/EPA/CARB Tier IVi (non-road).

Compression and exhaust brakes.

Fuel tank capacity

400 L (106 gal).

Transmission

Daimler Chrysler, 16 speed G240-16. Two-speed transfer case with interaxle differential lock.

Drive/steer

10x6x10

Specifications

Carrier continued

Axles

1st axle line – steer
2nd axle line – drive/steer
3rd axle line – steer (optional drive off-highway)
4th axle line – drive/steer (connects for all wheel steer)
5th axle line – drive/steer
Drive axles with planetary hub reduction and center mounted differential-gearing. Inter-axle and cross axle differential locks.

Suspension

Exclusive MEGATRAK™ suspension. Independent hydro-pneumatic system acting on all wheels with hydraulic lockout. Suspension can be raised 170 mm (6.7 in) or lowered 130 mm (5.1 in) both longitudinally and transversely. Features an automatic leveling system for highway travel.

Tires

10 tires, 445/95 R25 (16.00 R25)
(vehicle width: 3,00 m [9.8 ft])

Steering

Dual circuit, hydraulic power assisted steering system. Transfer case mounted, ground driven emergency steering pump. Axles 1, 2, 3 and 5 steer on highway. Separate steering of the 4th and 5th axles for all wheel and crab steering, controlled by an electronic rocker switch.

Brakes

Service brakes: pneumatic dual circuit acting on all wheels, anti lock prevention.
Parking brake: pneumatically operated spring loaded brake acting on axle lines 2, 4 and 5.
Air dryer.

Cab

Two-man construction with the following features: safety glass, driver seat with suspension, passenger seat, heated rear view mirrors, engine independent diesel cab heater, AC, complete instrumentation and driving controls.

Electrical system

24V system with three phase alternator, 28V/100A
2 batteries, 12V/170 Ah

Maximum speed

85 kph (53 mph)

Gradeability (theoretical)

60% - 14.00 tires
54% - 16.00/20.5 tires

Miscellaneous standard equipment

Work light, tool kit, fire extinguisher, auxiliary boom nose; radio/CD player in carrier cab, cruise control, wind speed indicator and worklights for each outrigger beam, CraneSTAR asset management system.

*Optional equipment

- ▶ Stainless steel exhaust system with spark arrestor
- ▶ 525/80 R25 tires (20.5 R25)
(vehicle width 3,1 m [10,2 ft])
- ▶ 385/95 R25 tires (14.00 R25)
(vehicle width 3,0 m [9.8 ft])
- ▶ 10x8x10 drive/steer
- ▶ Electric driveline retarder
- ▶ Steel outrigger pads
- ▶ Spare tire with carry bracket
- ▶ Outrigger pad load indicator
- ▶ Hinged bunk bed
- ▶ Trailer and towing hitches
- ▶ Rear mounted stowage box
- ▶ Optional engine: Tier III Mercedes-Benz OM 502 LA, 390 kW (512 bhp) at 1800 rpm.
Max torque 2400 Nm at 1300 rpm

Dimensions

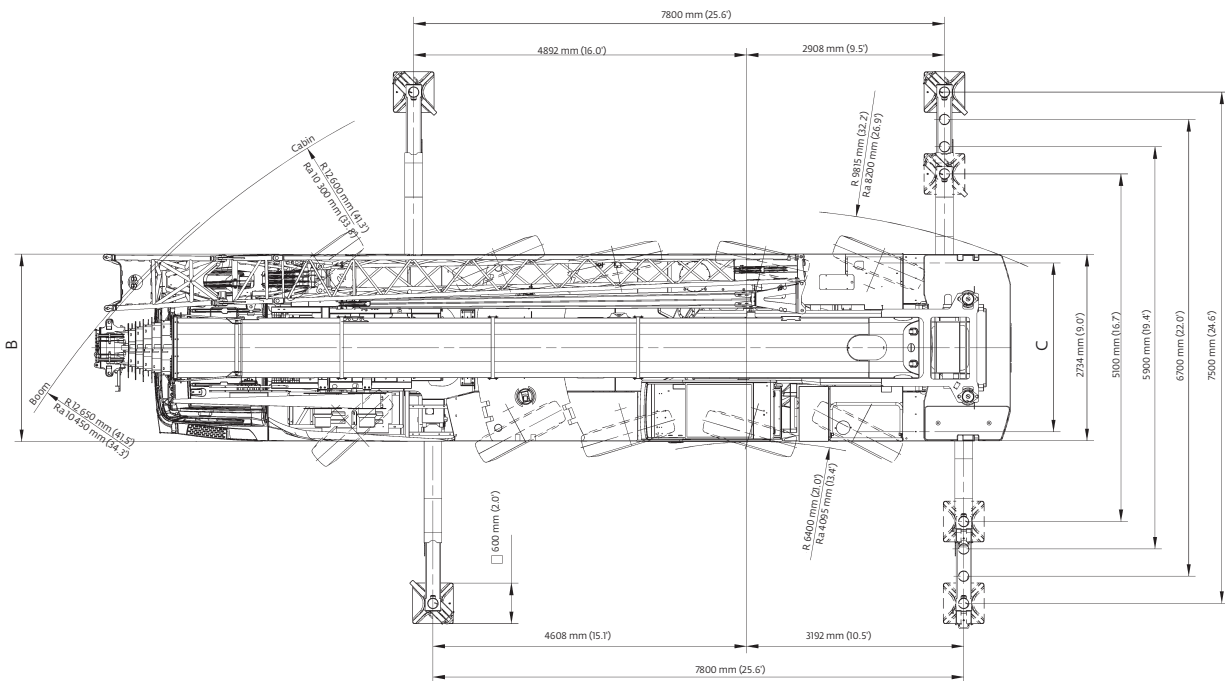
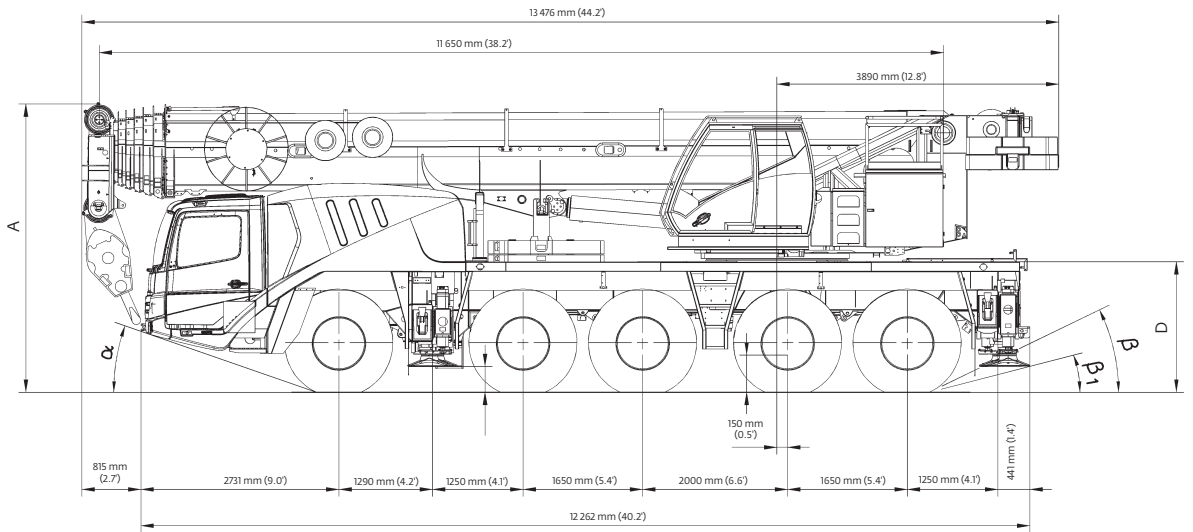

	A	A 130 mm ^ø (5.1")	B	C	D	E	F	α	β	β1
14.00 R25	3945 mm (12.9')	3815 mm (12.5')	2750 mm (9.0')	2338 mm (7.7')	1750 mm (5.7')	435 mm (1.4')	356 mm (1.2')	18°	23°	17°
16.00 R25	3995 mm (13.1')	3865 mm (12.7')	3000 mm (9.8')	2486 mm (8.2')	1800 mm (5.9')	485 mm (1.6')	386 mm (1.3')	20°	25°	19°
20.5 R25	3995 mm (13.1')	3865 mm (12.7')	3100 mm (10' 2")	2507 mm (8.2')	1800 mm (5.9')	485 mm (1.6')	386 mm (1.3')	20°	25°	19°

Ra= Radius all wheels steered
 °Lowered

Counterweight

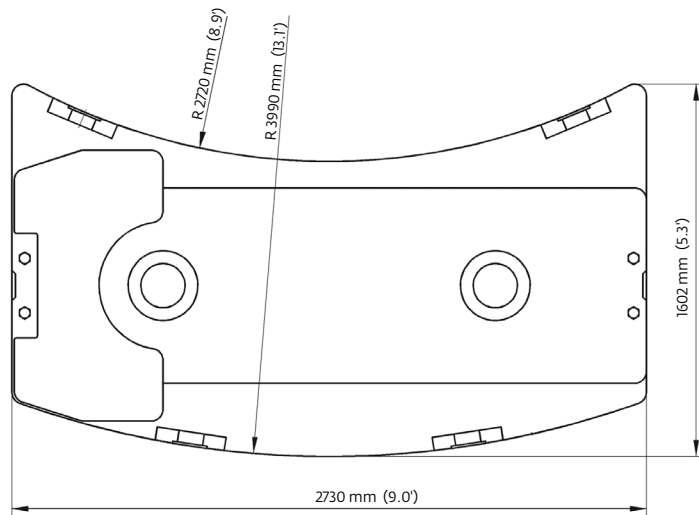
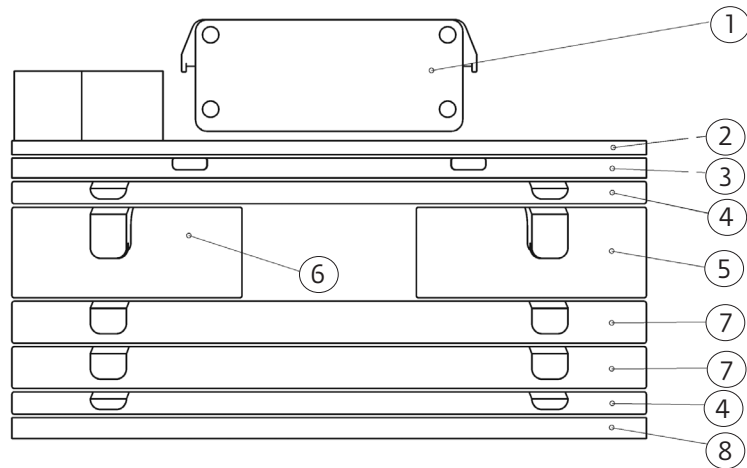

- | | |
|--|--------------------------------|
| 1. 600 kg (1323 lb) Bolted (Aux. Hoist or IPO) | 5. 3300 kg (7275 lb) Stacking |
| 2. 2300 kg (5071 lb) Bolted | 6. 3300 kg (7275 lb) Stacking |
| 3. 2200 kg (4850 lb) Stacking | 7. 4400 kg (9700 lb) Stacking |
| 4. 2200 kg (4850 lb) Stacking | 8. 2200 kg (4850 lb) Baseplate |

	1	2	3	4	5	6	7	8
Counterweight Configuration kg (lb)								
2900 (6300)	•	•						
5100 (11,200)	•	•						•
7300 (16,000)	•	•	•					•
9500 (20,900)	•	•					•	•
11 700 (25,700)	•	•	•				•	•
13 900 (30,600)	•	•	•		•	•		•
16 100 (35,400)	•	•	•	•	•	•		•
18 300 (40,300)	•	•	•	2•	•	•		•
20 500 (45,100)	•	•	•	•	•	•	•	•
22 700 (50,000)	•	•	•		•	•	2•	•
24 900 (54,800)	•	•	•	•	•	•	2•	•
27 100 (59,200)	•	•	•	2•	•	•	2•	•

Weight proposal

Trailing boom

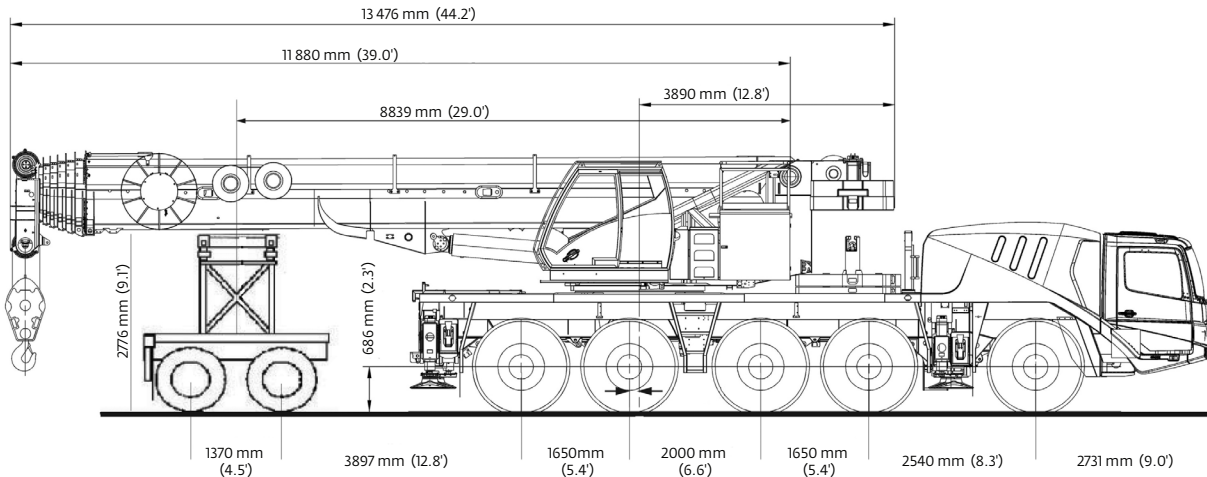

Dolly	Rear 3 axles	Front 2 axles	Total
12 040 kg 26,544 lb	22 952 kg 50,599 lb	18 417 kg 40,601 lb	53 409 kg 117,745 lb

Unit Configuration:

- | | |
|--------------------------------------|---|
| 38 ft – 197 ft boom | 33 ft – 56 ft hydraulic luffing swingaway |
| Outrigger pads stowed on unit | Additional oil cooler |
| 10 X 8 X 10 drive/steer | 20.5 tires |
| Main and auxiliary hoists with cable | 2 axle boom dolly (2590 kg [5710 lb]) |
| | Fixed counterweight (2300kg [5070 lb]) |

Boom over front						
Basic weights - kg (lb)	Axles 1 and 2		Axles 3-5		Total	
Mercedes-Benz power Tier 4i, 16.00R25 tires, 10x6x10 drive/steer, second oil cooler, outrigger pads, auxiliary hoist, 2,3 t (5070 lb) fixed counterweight, driver and tanks filled	16 942	37,351	31 118	68,603	48 066	105,954
Additions:						
10x8x10 drive/steer	272	600	82	181	354	780
Electric driveline retarder	- 74	-163	334	736	260	573
Spare wheel 14.00 R25 XGC steel rim with stowage	- 182	-401	421	928	239	527
Spare wheel 16.00 R25 XGC steel rim with stowage	- 225	-496	520	1146	295	650
Spare wheel 20.5 R25 XGC steel rim with stowage	- 261	-575	603	1329	342	754
Brackets for hydraulic swingaway	65	143	16	35	81	179
Hose reel + parts for hydraulic swingaway	271	597	- 81	-179	190	419
10 m - 17 m (33 ft - 56 ft) hydraulic swingaway	1287	2837	80	176	1367	3014
10 m - 17 m (33 ft - 56 ft) hydraulic swingaway with integrated heavy duty jib	1475	3252	41	90	1516	3342
2200 kg (4850 lb) section 3 pinned to superstructure	-1475	-3252	3675	8102	2200	4850
2200 kg (4850 lb) section 8 stowed on carrier	1506	3320	694	1530	2200	4850
Substitutions:						
14.00R25 tires	- 240	-529	- 362	-798	- 602	-1327
20.5R25 tires	172	379	257	567	429	946
Removals:						
Boom assembly	-9598	-21,160	-3877	-8547	-13 475	-29,707
Front outriggers	-1424	-3139	- 6	-13	-1430	-3153
Rear outriggers	954	2103	-2473	-5452	-1519	-3349
Front and rear outrigger floats	- 26	-57	- 114	-251	- 140	-309

Working range

Main boom

11,7 m - 60 m (38.2 ft - 196.9 ft) main boom

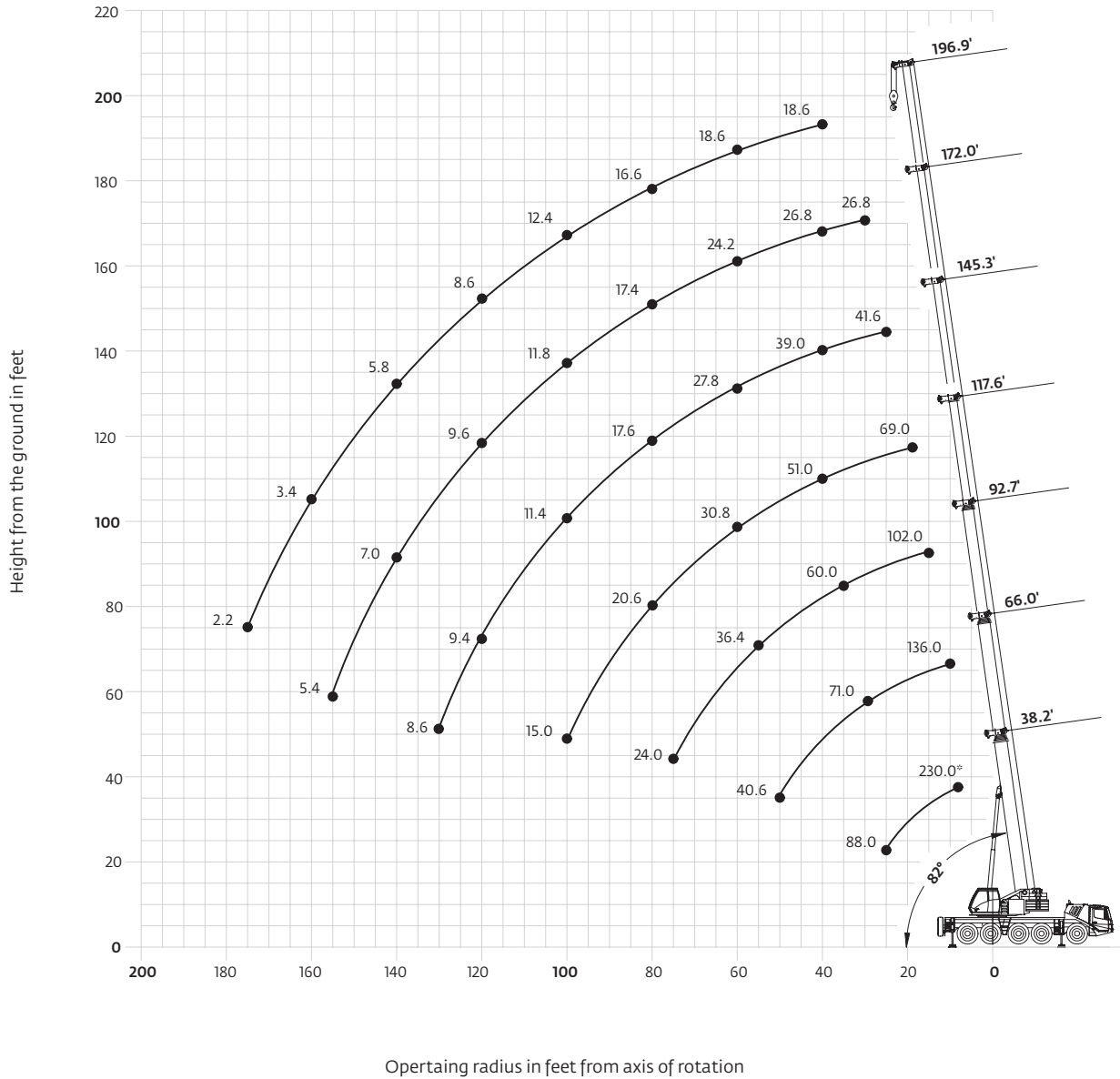

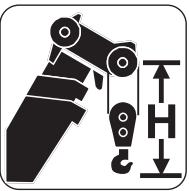





	Hookblock (t)	H mm (ft)
	100 D	3100 (10.2)
70 S/D	3000 (9.8)	
40 S/D	2900 (9.5)	
20 S/D	2800 (9.2)	
8 H/B	2350 (7.7)	

Hook heights shown in the working range diagram do not consider loaded boom deflection.

Load charts





Main boom



 11,7 m - 60 m (38.2 ft - 196.9 ft)
  27 100 kg (59,700 lb)
  25.6 ft x 24.6 ft spread (100%)
  360°

 Pounds x 1000

Feet	38.2	52.2	66.0	79.6	92.7	105.4	117.6	131.5	145.3	158.9	172.0	184.7	196.9
8.0	230.0*												
9.0	173.0												
10.0	158.0	146.0	136.0	130.0									
15.0	127.0	121.0	114.0	108.0	102.0								
20.0	106.0	101.0	95.0	93.0	87.0	84.0	69.0	53.0					
25.0	88.0	87.0	81.0	79.0	77.0	74.0	69.0	53.0	41.6				
30.0		75.0	71.0	69.0	68.0	65.0	64.0	52.0	41.6	33.2	26.8		
35.0		63.0	63.0	61.0	60.0	58.0	57.0	48.0	41.2	33.2	26.8	22.0	
40.0		54.0	54.0	54.0	54.0	51.0	51.0	43.6	39.0	33.0	26.8	22.0	18.6
45.0			47.0	46.0	47.0	45.0	46.0	39.4	36.0	32.6	26.8	22.0	
50.0			40.6	40.2	41.2	40.0	39.6	36.4	33.2	30.4	26.8	22.0	18.6
55.0				36.4	36.4	36.8	34.8	32.6	30.6	28.0	25.6	22.0	18.6
60.0				32.8	32.2	33.2	30.8	28.8	27.8	25.6	24.2	21.8	18.6
65.0				29.0	28.2	29.6	27.4	26.4	24.6	23.8	22.6	21.0	18.6
70.0					25.6	26.4	24.6	25.0	22.0	21.8	21.0	19.8	18.2
75.0					24.0	23.6	22.2	22.8	19.6	19.4	19.4	18.8	17.4
80.0						21.0	20.6	20.8	17.6	17.4	17.4	17.6	16.6
85.0						19.0	19.8	18.8	15.8	15.6	15.8	16.2	15.8
90.0						17.0	18.2	17.0	14.2	14.6	14.2	14.6	15.0
95.0							16.4	15.2	12.8	13.4	12.8	13.2	13.6
100.0							15.0	13.8	11.4	12.4	11.8	12.0	12.4
105.0								12.6	10.8	11.8	11.2	11.2	11.4
110.0								11.4	10.2	11.2	10.6	10.6	10.4
115.0								10.2	9.8	10.8	10.2	10.0	9.4
120.0									9.4	10.2	9.6	9.6	8.6
125.0									9.0	9.2	9.2	8.8	7.8
130.0									8.6	8.4	8.4	8.0	7.2
135.0										7.8	7.6	7.2	6.4
140.0										7.2	7.0	6.6	5.8
145.0											6.6	6.0	5.2
150.0											6.0	5.4	4.6
155.0											5.4	4.8	4.0
160.0												4.4	3.4
165.0												3.8	3.0
170.0												3.4	2.6
175.0													2.2

* Over the rear with special equipment

 11,7 m - 60 m (38.2 ft - 196.9 ft)
  22 700 kg (50,000 lb)
  25.6 ft x 24.6 ft spread (100%)
  360°

 Pounds x 1000

Feet	38.2	52.2	66.0	79.6	92.7	105.4	117.6	131.5	145.3	158.9	172.0	184.7	196.9
8.0	185.0												
9.0	173.0												
10.0	158.0	146.0	136.0	130.0									
15.0	127.0	121.0	114.0	108.0	102.0								
20.0	106.0	101.0	95.0	93.0	87.0	84.0	69.0	53.0					
25.0	88.0	87.0	81.0	79.0	77.0	74.0	69.0	53.0	41.6				
30.0		73.0	71.0	69.0	68.0	65.0	64.0	52.0	41.6	33.2	26.8		
35.0		61.0	61.0	61.0	60.0	57.0	57.0	48.0	41.2	33.2	26.8	22.0	
40.0		51.0	52.0	51.0	51.0	48.0	48.0	43.6	39.0	33.0	26.8	22.0	18.6
45.0			44.0	43.6	43.6	43.8	41.2	38.6	36.0	32.6	26.8	22.0	18.6
50.0			38.0	39.6	37.8	38.2	35.6	33.4	32.2	30.4	26.6	22.0	18.6
55.0				34.0	33.0	33.6	31.2	30.2	28.0	27.6	25.6	22.0	18.6
60.0				29.6	30.0	29.8	27.6	28.2	24.6	24.2	24.2	21.8	18.6
65.0				26.0	27.4	26.6	24.4	24.0	21.8	21.4	21.4	21.0	18.6
70.0					24.2	23.6	23.0	22.6	19.2	19.0	19.0	19.4	18.2
75.0					21.6	21.0	21.8	20.2	17.0	17.2	17.0	17.4	17.4
80.0						18.6	19.8	18.4	15.2	16.2	15.8	16.2	16.0
85.0						17.8	17.8	16.6	13.8	15.4	14.6	15.0	14.4
90.0						16.8	16.0	14.8	12.8	14.6	13.4	13.6	13.0
95.0							14.4	13.2	12.0	13.4	12.6	12.8	11.8
100.0							13.2	12.0	11.4	12.4	11.8	11.8	10.6
105.0								10.8	10.8	11.6	11.2	10.8	9.6
110.0								9.6	10.2	10.6	10.4	9.8	8.6
115.0								8.6	9.8	9.6	9.6	8.8	7.8
120.0									9.4	8.8	8.6	8.0	7.0
125.0									8.8	8.2	8.0	7.4	6.2
130.0									8.0	7.8	7.2	6.6	5.6
135.0										7.2	6.6	5.8	5.0
140.0										6.6	6.0	5.2	4.4
145.0											5.4	4.6	3.8
150.0											4.8	4.0	3.2
155.0											4.2	3.6	2.8
160.0												3.0	2.2
165.0												2.6	2.2
170.0												2.6	2.2

Load charts

Main boom



11,7 m - 60 m
(38.2 ft - 196.9 ft)



2900 kg
(6300 lb)



25.6 ft x 24.6 ft spread
(100%)



360°





Pounds x 1000

Feet	38.2	52.2	66.0	79.6	92.7	105.4	117.6	131.5	145.3	158.9	172.0	184.7	196.9
8.0	185.0												
9.0	173.0												
10.0	158.0	146.0	136.0	130.0									
15.0	127.0	121.0	114.0	108.0	102.0								
20.0	94.0	91.0	84.0	81.0	74.0	72.0	65.0	53.0					
25.0	67.0	65.0	63.0	59.0	58.0	54.0	49.0	46.0	41.6				
30.0		48.0	47.0	47.0	44.0	40.8	40.8	37.0	31.8	30.6	26.8		
35.0		38.2	38.4	37.2	35.0	35.2	32.6	29.6	29.4	28.2	24.2	22.0	
40.0		28.6	30.8	30.0	29.6	28.8	26.6	25.4	25.8	24.6	23.0	20.8	18.6
45.0			25.2	24.8	25.6	24.2	22.2	23.4	22.0	20.8	19.4	17.8	16.2
50.0			20.4	21.6	21.6	20.4	19.8	20.0	18.8	17.6	16.4	15.0	13.4
55.0				18.8	18.6	18.6	18.0	17.2	16.2	15.0	14.0	12.6	11.2
60.0				15.8	16.0	16.2	15.6	15.0	14.0	13.0	11.8	10.6	9.4
65.0				13.2	13.6	14.2	13.6	13.0	12.0	11.2	10.2	9.0	7.8
70.0					11.8	12.4	11.8	11.4	10.4	9.6	8.6	7.6	6.2
75.0					10.2	10.6	10.4	10.0	9.2	8.2	7.4	6.2	5.0
80.0						9.2	9.2	8.8	8.0	7.2	6.2	5.2	4.0
85.0						8.0	8.0	7.6	6.8	6.0	5.2	4.2	3.0
90.0						7.0	6.8	6.6	5.8	5.2	4.2	3.2	2.2
95.0							5.8	5.8	5.0	4.4	3.4	2.6	
100.0							3.4	4.8	4.2	3.6	2.8		
105.0								4.2	3.6	3.0	2.2		
110.0								3.4	3.0	2.4			
115.0									2.4				

Working range

Hydraulic offsettable swingaway

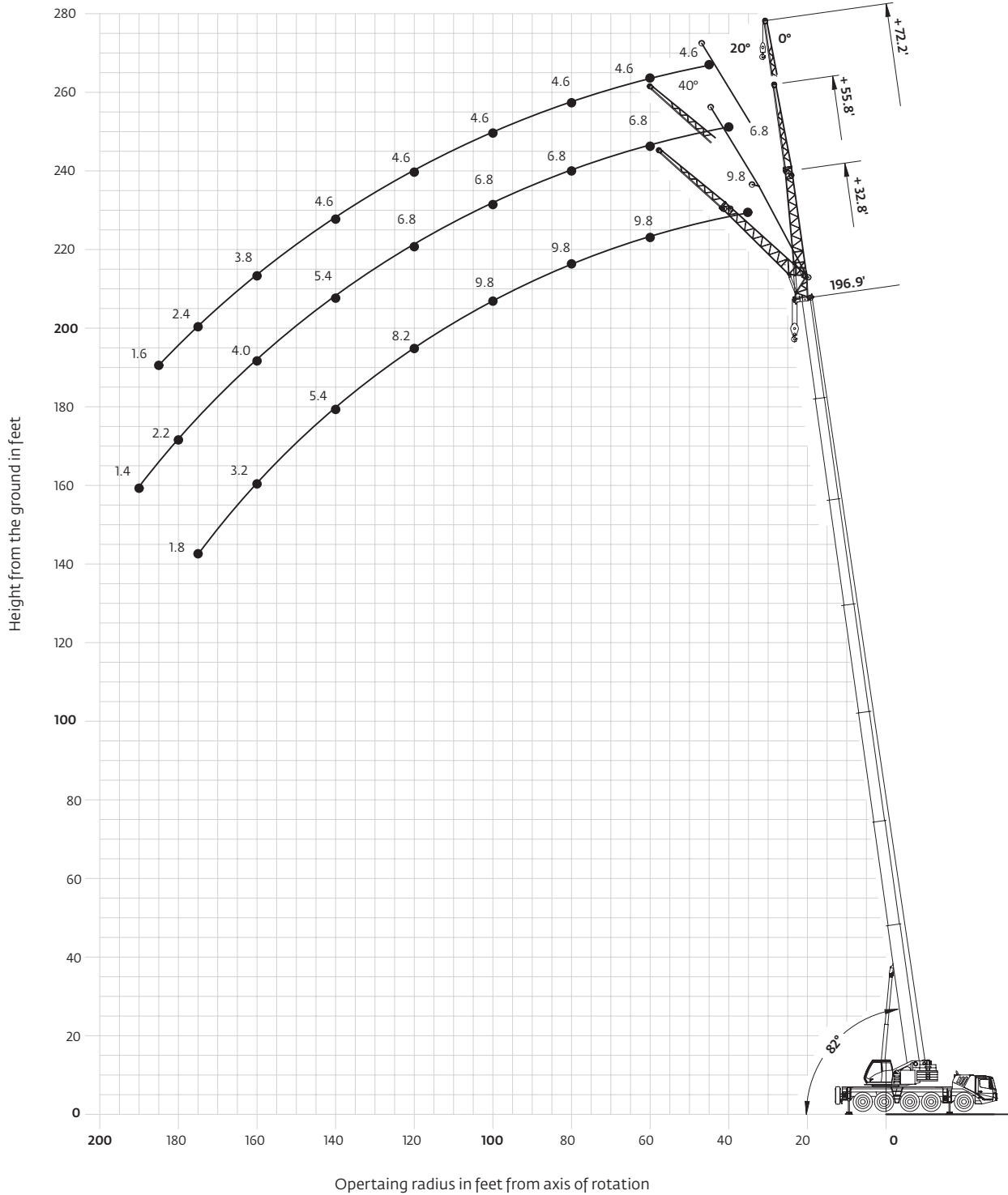
60 m (197 ft) main boom with 10 m - 17 m (33 ft - 56 ft) swingaway and 1 x 5 m (16 ft) insert



Hook heights shown in the working range diagram do not consider loaded boom deflection.

Load charts

Hydraulic offsettable swingaway

Intermediate angle

60 m (196.9 ft)
 10-17-72 m (33-56-22 ft)
 27 100 kg (59,700 lb)
 25.6 ft x 24.6 ft spread (100%)
 360°

Pounds x 1000

Feet	197' + 33'			197' + 56'			197' + 72'		
	0°	0° - 20°	20° - 40°	0°	0° - 20°	20° - 40°	0°	0° - 20°	20° - 40°
30.0									
35.0	9.8								
40.0	9.8			6.8					
45.0	9.8			6.8			4.6		
50.0	9.8			6.8			4.6		
55.0	9.8	9.2		6.8			4.6		
60.0	9.8	9.2	8.8	6.8			4.6		
65.0	9.8	9.2	8.8	6.8			4.6		
70.0	9.8	9.2	8.8	6.8	6.2		4.6		
75.0	9.8	9.2	8.8	6.8	6.2		4.6	4.6	
80.0	9.8	9.2	8.8	6.8	6.2	5.4	4.6	4.6	4.6
85.0	9.8	9.2	8.8	6.8	6.2	5.4	4.6	4.6	4.6
90.0	9.8	9.2	8.8	6.8	6.2	5.4	4.6	4.6	4.6
95.0	9.8	9.2	8.8	6.8	6.2	5.4	4.6	4.6	4.6
100.0	9.8	9.2	8.8	6.8	6.2	5.4	4.6	4.6	4.6
105.0	9.6	9.2	8.8	6.8	6.2	5.4	4.6	4.6	4.6
110.0	9.2	9.0	8.8	6.8	6.2	5.4	4.6	4.6	4.6
115.0	8.4	8.4	8.8	6.8	6.2	5.4	4.6	4.6	4.6
120.0	7.6	7.6	8.2	6.8	6.2	5.4	4.6	4.6	4.6
125.0	6.8	6.8	7.4	6.8	6.2	5.4	4.6	4.6	4.6
130.0	6.2	6.2	6.6	6.4	6.2	5.4	4.6	4.6	4.6
135.0	5.4	5.4	6.0	5.8	5.8	5.4	4.6	4.6	4.6
140.0	4.8	4.8	5.4	5.2	5.2	5.4	4.6	4.6	4.6
145.0	4.4	4.4	4.8	4.6	4.6	5.4	4.4	4.4	4.6
150.0	3.8	3.8	4.2	4.2	4.2	5.0	3.8	3.8	4.6
155.0	3.4	3.4	3.8	3.6	3.6	4.4	3.4	3.4	4.2
160.0	2.8	2.8	3.2	3.2	3.2	4.0	3.0	3.0	3.8
165.0	2.4	2.4	2.8	2.8	2.8	3.4	2.4	2.4	3.2
170.0	2.0	2.0	2.4	2.4	2.4	3.0	2.0	2.0	2.8
175.0	1.6	1.6	1.8	2.0	2.0	2.6	1.8	1.8	2.4
180.0				1.6	1.6	2.2			2.0
185.0						1.8			1.6
190.0						1.4			

Loads for luffing

60 m (196.9 ft)
 10-17-72 m (33-56-22 ft)
 27 100 kg (59,700 lb)
 25.6 ft x 24.6 ft spread (100%)
 360°

Pounds x 1000

Feet	197' + 33'		197' + 56'		197' + 72'	
	0° - 20°	20° - 40°	0° - 20°	20° - 40°	0° - 20°	20° - 40°
50.0						
55.0	8.8					
60.0	8.8	8.4				
65.0	8.8	8.4				
70.0	8.8	8.4	6.0			
75.0	8.8	8.4	6.0		4.4	
80.0	8.8	8.4	6.0	5.2	4.4	
85.0	8.8	8.4	6.0	5.2	4.4	4.4
90.0	8.8	8.4	6.0	5.2	4.4	4.4
95.0	8.8	8.4	6.0	5.2	4.4	4.4
100.0	8.8	8.4	6.0	5.2	4.4	4.4
105.0	8.8	8.4	6.0	5.2	4.4	4.4
110.0	8.6	8.4	6.0	5.2	4.4	4.4
115.0	8.4	8.4	6.0	5.2	4.4	4.4
120.0	7.6	8.0	6.0	5.2	4.4	4.4
125.0	6.8	7.4	5.8	5.2	4.4	4.4
130.0	6.0	6.6	5.6	5.2	4.4	4.4
135.0	5.4	6.0	5.6	5.2	4.4	4.4
140.0	4.8	5.2	5.2	5.0	4.4	4.4
145.0	4.2	4.6	4.6	5.0	4.4	4.4
150.0	3.6	4.0	4.2	5.0	3.8	4.4
155.0	3.2	3.6	3.6	4.4	3.4	4.2
160.0	2.6	3.0	3.2	3.8	3.0	3.8
165.0	2.2	2.6	2.8	3.4	2.4	3.2
170.0	1.8	2.2	2.4	3.0	2.0	2.8
175.0		1.8	2.0	2.4	1.8	2.4
180.0			1.6	2.0		2.0
185.0				1.8		1.6

THIS CHART IS ONLY A GUIDE AND SHOULD NOT BE USED TO OPERATE THE CRANE.

The individual crane's load chart, operating instructions and other instructional plates must be read and understood prior to operating the crane

Load charts

Hydraulic offsettable swingaway

Intermediate angle



Feet	Pounds x 1000											
	0°	197' + 33' 0° - 20°		20° - 40°	0°	197' + 56' 0° - 20°		20° - 40°	0°	197' + 72' 0° - 20°		20° - 40°
30.0												
35.0	9.8											
40.0	9.8				6.8							
45.0	9.8				6.8				4.6			
50.0	9.8				6.8				4.6			
55.0	9.8	9.2			6.8				4.6			
60.0	9.8	9.2	8.8		6.8				4.6			
65.0	9.8	9.2	8.8		6.8				4.6			
70.0	9.8	9.2	8.8		6.8	6.2			4.6			
75.0	9.8	9.2	8.8		6.8	6.2			4.6	4.6		
80.0	9.8	9.2	8.8		6.8	6.2	5.4		4.6	4.6	4.6	
85.0	9.8	9.2	8.8		6.8	6.2	5.4		4.6	4.6	4.6	
90.0	9.8	9.2	8.8		6.8	6.2	5.4		4.6	4.6	4.6	
95.0	9.8	9.2	8.8		6.8	6.2	5.4		4.6	4.6	4.6	
100.0	9.4	9.2	8.8		6.8	6.2	5.4		4.6	4.6	4.6	
105.0	8.6	8.6	8.8		6.8	6.2	5.4		4.6	4.6	4.6	
110.0	7.6	7.6	8.4		6.8	6.2	5.4		4.6	4.6	4.6	
115.0	6.8	6.8	7.4		6.8	6.2	5.4		4.6	4.6	4.6	
120.0	6.0	6.0	6.6		6.4	6.2	5.4		4.6	4.6	4.6	
125.0	5.2	5.2	6.0		5.6	5.6	5.4		4.6	4.6	4.6	
130.0	4.6	4.6	5.2		5.0	5.0	5.4		4.6	4.6	4.6	
135.0	4.0	4.0	4.6		4.4	4.4	5.4		4.2	4.2	4.6	
140.0	3.4	3.4	4.0		3.8	3.8	4.8		3.6	3.6	4.6	
145.0	3.0	3.0	3.4		3.4	3.4	4.2		3.0	3.0	4.0	
150.0	2.4	2.4	2.8		2.8	2.8	3.6		2.6	2.6	3.4	
155.0	2.0	2.0	2.4		2.4	2.4	3.2		2.2	2.2	3.0	
160.0	1.6	1.6	2.0		2.0	2.0	2.8		1.6	1.6	2.4	
165.0			1.6		1.6	1.6	2.2				2.0	
170.0							1.8					1.6

Loads for luffing



Feet	Pounds x 1000								
	0° - 20°	197' + 33' 20° - 40°		0° - 20°	197' + 56' 20° - 40°		0° - 20°	197' + 72' 20° - 40°	
50.0									
55.0	8.8								
60.0	8.8	8.4							
65.0	8.8	8.4							
70.0	8.8	8.4		6.0					
75.0	8.8	8.4		6.0			4.4		
80.0	8.8	8.4		6.0	5.2		4.4	4.4	
85.0	8.8	8.4		6.0	5.2		4.4	4.4	4.4
90.0	8.8	8.4		6.0	5.2		4.4	4.4	4.4
95.0	8.8	8.4		6.0	5.2		4.4	4.4	4.4
100.0	8.8	8.4		6.0	5.2		4.4	4.4	4.4
105.0	8.6	8.4		6.0	5.2		4.4	4.4	4.4
110.0	7.6	8.4		6.0	5.2		4.4	4.4	4.4
115.0	6.8	7.4		6.0	5.2		4.4	4.4	4.4
120.0	6.0	6.6		6.0	5.2		4.4	4.4	4.4
125.0	5.2	6.0		5.6	5.2		4.4	4.4	4.4
130.0	4.6	5.2		5.0	5.2		4.4	4.4	4.4
135.0	4.0	4.6		4.4	5.2		4.2	4.4	4.4
140.0	3.4	4.0		3.8	4.8		3.6	4.4	4.4
145.0	3.0	3.4		3.4	4.2		3.0	4.0	4.0
150.0	2.4	2.8		2.8	3.6		2.6	3.4	3.4
155.0	2.0	2.4		2.4	3.2		2.2	3.0	3.0
160.0	1.6	2.0		2.0	2.8		1.6	2.4	2.4
165.0		1.4		1.6	2.2			2.0	2.0
170.0					1.8				1.6

THIS CHART IS ONLY A GUIDE AND SHOULD NOT BE USED TO OPERATE THE CRANE.

Load charts

Manual offsettable swingaway

Manual offset

60 m (196.9 ft)
 10-17-72 m (33-56-22 ft)
 27 100 kg (59,700 lb)
 25.6 ft x 24.6 ft spread (100%)
 360°

Pounds x 1000

Feet	197' + 33'			197' + 56'			197' + 72'		
	0°	20°	40°	0°	20°	40°	0°	20°	40°
30.0									
35.0	9.8								
40.0	9.8			6.8					
45.0	9.8			6.8			4.6		
50.0	9.8	9.8		6.8			4.6		
55.0	9.8	9.8	8.8	6.8			4.6		
60.0	9.8	9.8	8.8	6.8	6.8		4.6	4.6	
65.0	9.8	9.8	8.8	6.8	6.8		4.6	4.6	
70.0	9.8	9.8	8.8	6.8	6.8		4.6	4.6	
75.0	9.8	9.8	8.8	6.8	6.8	5.4	4.6	4.6	4.6
80.0	9.8	9.8	8.8	6.8	6.8	5.4	4.6	4.6	4.6
85.0	9.8	9.8	8.8	6.8	6.8	5.4	4.6	4.6	4.6
90.0	9.8	9.8	8.8	6.8	6.8	5.4	4.6	4.6	4.6
95.0	9.8	9.8	8.8	6.8	6.8	5.4	4.6	4.6	4.6
100.0	9.8	9.6	8.8	6.8	6.8	5.4	4.6	4.6	4.6
105.0	9.6	9.4	8.8	6.8	6.8	5.4	4.6	4.6	4.6
110.0	9.2	9.0	8.8	6.8	6.8	5.4	4.6	4.6	4.6
115.0	8.4	8.8	8.8	6.8	6.8	5.4	4.6	4.6	4.6
120.0	7.6	8.2	8.6	6.8	6.6	5.4	4.6	4.6	4.6
125.0	6.8	7.4	7.8	6.8	6.6	5.4	4.6	4.6	4.6
130.0	6.2	6.6	7.0	6.4	6.4	5.4	4.6	4.6	4.6
135.0	5.4	6.0	6.4	5.8	6.2	5.4	4.6	4.6	4.6
140.0	4.8	5.4	5.6	5.2	6.2	5.4	4.6	4.6	4.6
145.0	4.4	4.8	5.0	4.6	5.6	5.4	4.4	4.6	4.6
150.0	3.8	4.2	4.4	4.2	5.0	5.4	3.8	4.6	4.6
155.0	3.4	3.8	4.0	3.6	4.4	5.0	3.4	4.2	4.4
160.0	2.8	3.2	3.4	3.2	4.0	4.4	3.0	3.8	4.2
165.0	2.4	2.8	3.0	2.8	3.4	4.0	2.4	3.2	3.8
170.0	2.0	2.4	2.4	2.4	3.0	3.4	2.0	2.8	3.2
175.0	1.6	1.8	2.0	2.0	2.6	3.0	1.8	2.4	2.8
180.0				1.6	2.2	2.6		2.0	2.4
185.0					1.8	2.0		1.6	2.0
190.0					1.4	1.6			1.6

Manual offset

60 m (196.9 ft)
 10-17-72 m (33-56-22 ft)
 22 700 kg (50,000 lb)
 25.6 ft x 24.6 ft spread (100%)
 360°

Pounds x 1000

Feet	196.9' + 33'			196.9' + 56'			196.9' + 72'		
	0°	20°	40°	0°	20°	40°	0°	20°	40°
30.0									
35.0	9.8								
40.0	9.8			6.8					
45.0	9.8			6.8			4.6		
50.0	9.8	9.8		6.8			4.6		
55.0	9.8	9.8	8.8	6.8			4.6		
60.0	9.8	9.8	8.8	6.8	6.8		4.6	4.6	
65.0	9.8	9.8	8.8	6.8	6.8		4.6	4.6	
70.0	9.8	9.8	8.8	6.8	6.8		4.6	4.6	
75.0	9.8	9.8	8.8	6.8	6.8	5.4	4.6	4.6	4.6
80.0	9.8	9.8	8.8	6.8	6.8	5.4	4.6	4.6	4.6
85.0	9.8	9.8	8.8	6.8	6.8	5.4	4.6	4.6	4.6
90.0	9.8	9.8	8.8	6.8	6.8	5.4	4.6	4.6	4.6
95.0	9.8	9.8	8.8	6.8	6.8	5.4	4.6	4.6	4.6
100.0	9.4	9.6	8.8	6.8	6.8	5.4	4.6	4.6	4.6
105.0	8.6	9.2	8.8	6.8	6.8	5.4	4.6	4.6	4.6
110.0	7.6	8.4	8.8	6.8	6.8	5.4	4.6	4.6	4.6
115.0	6.8	7.4	8.0	6.8	6.8	5.4	4.6	4.6	4.6
120.0	6.0	6.6	7.2	6.4	6.6	5.4	4.6	4.6	4.6
125.0	5.2	6.0	6.4	5.6	6.6	5.4	4.6	4.6	4.6
130.0	4.6	5.2	5.6	5.0	6.0	5.4	4.6	4.6	4.6
135.0	4.0	4.6	5.0	4.4	5.4	5.4	4.2	4.6	4.6
140.0	3.4	4.0	4.2	3.8	4.8	5.4	3.6	4.6	4.6
145.0	3.0	3.4	3.6	3.4	4.2	4.8	3.0	4.0	4.6
150.0	2.4	2.8	3.2	2.8	3.6	4.2	2.6	3.4	4.2
155.0	2.0	2.4	2.6	2.4	3.2	3.8	2.2	3.0	3.6
160.0	1.6	2.0	2.2	2.0	2.8	3.2	1.6	2.4	3.0
165.0		1.6	1.6	1.6	2.2	2.8		2.0	2.6
170.0					1.8	2.2		1.6	2.0
175.0						1.8			1.6

THIS CHART IS ONLY A GUIDE AND SHOULD NOT BE USED TO OPERATE THE CRANE.

The individual crane's load chart, operating instructions and other instructional plates must be read and understood prior to operating the crane.

Working range

Heavy duty jib

11,7 m - 60 m (38.2 ft - 196.9 ft) main boom with 3,3 m (10.8 ft) heavy duty jib

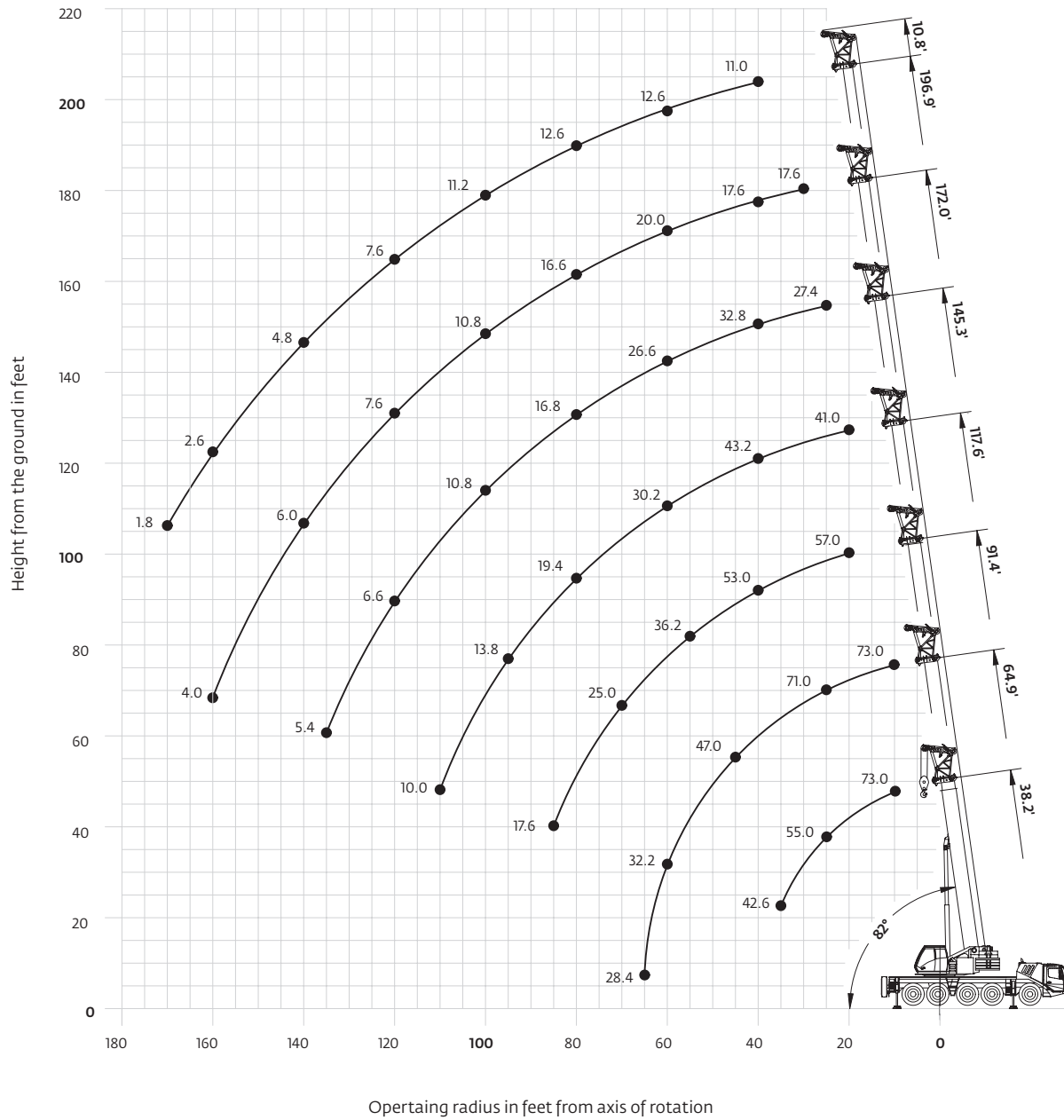





Hook heights shown in the working range diagram do not consider loaded boom deflection.

Load charts





Integrated heavy duty jib

Intermediate angle

 11,7 m - 60 m (38 ft - 196.9 ft)
  3,3 m (10.8 ft)
  27 100 kg (59,700 lb)
  25.6 ft x 24.6 ft spread (100%)
  360°

Feet	38.2' + 10.8'				64.9' + 10.8'				91.4' + 10.8'				117.6' + 10.8'				145.3' + 10.8'				172.0' + 10.8'				196.9' + 10.8'			
	0°	20°	40°		0°	20°	40°		0°	20°	40°		0°	20°	40°		0°	20°	40°		0°	20°	40°		0°	20°	40°	
10.0	73.0	73.0	73.0				73.0																					
15.0	71.0	65.0	66.0				73.0																					
20.0	60.0	57.0	59.0		73.0	71.0	70.0																					
25.0	51.0	51.0	55.0		71.0	65.0	65.0		73.0	68.0	57.0																	
30.0	45.0	46.0			63.0	59.0	61.0		64.0	64.0	57.0		49.0	46.0	41.0													
35.0	40.2	42.6			57.0	55.0	58.0		58.0	57.0	57.0		46.0	43.6	41.0													
40.0					52.0	51.0	54.0		52.0	52.0	53.0		43.2	41.2	41.0		32.8	29.6	27.4									
45.0					47.0	47.0	47.0		47.0	47.0	47.0		40.4	38.8	39.4		32.8	29.6	27.4		20.0	18.0	17.6					
50.0					41.2	41.2			41.0	41.0	41.4		37.8	36.6	37.4		30.6	29.6	27.4		20.0	18.0	17.6		12.6	11.0	11.0	
55.0					36.2	36.2			36.0	36.0	36.2		33.8	33.8	34.0		28.2	28.4	27.4		20.0	18.0	17.6		12.6	11.0	11.0	
60.0					32.2				31.8	31.8	32.0		29.8	30.0	30.2		25.6	25.6	26.6		20.0	18.0	17.6		12.6	11.0	11.0	
65.0					28.4				28.4	28.4	28.6		26.6	26.6	26.8		23.6	23.6	23.8		20.0	18.0	17.6		12.6	11.0	11.0	
70.0									25.0	25.0			23.8	23.8	24.0		21.0	21.0	21.2		19.4	18.0	17.6		12.6	11.0	11.0	
75.0									22.2	22.2			21.4	21.4	21.6		18.8	18.8	19.0		18.2	18.0	17.6		12.6	11.0	11.0	
80.0									19.8	19.8			19.2	19.4	19.4		16.8	16.8	16.8		16.6	16.6	16.6		12.6	11.0	11.0	
85.0									17.6	17.6			17.4	17.4	17.4		15.0	15.0	15.0		14.8	14.8	15.0		12.6	11.0	11.0	
90.0													15.4	15.6			13.4	13.4	13.6		13.2	13.2	13.4		12.6	11.0	11.0	
95.0													13.8	13.8			12.0	12.0	12.0		12.0	12.0	12.0		11.8	11.0	11.0	
100.0													12.4	12.4			10.8	10.8	10.8		10.6	10.6	10.8		11.2	11.0	11.0	
105.0													11.0	11.2			9.6	9.6	9.6		9.6	9.6	9.6		10.2	10.4	10.4	
110.0													10.0	10.0			8.4	8.4	8.4		8.6	8.8	8.8		9.2	9.4	9.4	
115.0																	7.4	7.4			8.2	8.2	8.2		8.2	8.4	8.6	
120.0																	6.6	6.6			7.6	7.6	7.6		7.4	7.6	7.6	
125.0																	6.2	6.2			7.2	7.2	7.2		6.6	6.8	6.8	
130.0																	5.8	5.8			6.6	6.6	6.6		6.0	6.2	6.2	
135.0																	5.4	4.0			6.2	6.2			5.4	5.4	5.6	
140.0																					6.0	5.8			4.8	4.8	4.8	
145.0																					5.6	5.4			4.2	4.2	4.4	
150.0																					5.2	5.0			3.6	3.8	3.8	
155.0																					4.6	4.6			3.0	3.2		
160.0																					4.0				2.6	2.6		
165.0																									2.0	2.2		
170.0																									1.6	1.8		

Loads for luffing

 11,7 m - 60 m (38 ft - 196.9 ft)
  3,3 m (10.8 ft)
  27 100 kg (59,700 lb)
  25.6 ft x 24.6 ft spread (100%)
  360°

Feet	38.2' + 10.8'		64.9' + 10.8'		91.4' + 10.8'		117.6' + 10.8'		145.3' + 10.8'		172.0' + 10.8'		196.9' + 10.8'	
	0°-20°	20°-40°	0°-20°	20°-40°	0°-20°	20°-40°	0°-20°	20°-40°	0°-20°	20°-40°	0°-20°	20°-40°	0°-20°	20°-40°
10.0	46.0	46.0												
15.0	43.4	44.0												
20.0	40.6	43.0		45.0	45.0									
25.0	38.6	42.8		43.8	44.0		45.0	45.0						
30.0	37.2			41.8	43.2		45.0	45.0						
35.0	36.6			40.2	42.8		43.8	44.0		41.6	39.0			
40.0				38.8	42.6		42.4	43.4		39.2	39.0			
45.0				37.8	42.8		41.0	43.0		36.8	37.6		29.6	26.0
50.0				37.0			39.4	39.4		34.8	35.6		29.0	26.0
55.0				34.0			34.2	34.4		33.0	34.0		27.0	26.0
60.0							29.6	29.8		29.6	29.6		24.4	25.2
65.0							26.0	26.0		25.8	25.8		22.6	23.0
70.0							22.8			22.6	22.8		21.0	21.2
75.0							20.2			20.0	20.0		18.6	18.8
80.0							18.0			17.8	17.8		16.4	16.6
85.0							16.0			15.8	15.8		14.4	14.6
90.0										14.2			12.8	12.8
95.0										12.6			11.2	11.4
100.0										11.4			10.0	10.0
105.0										10.2			8.8	8.8
110.0										9.0			7.8	7.8
115.0													6.8	
120.0													6.4	
125.0													6.0	
130.0													5.6	
135.0													3.8	
140.0														
145.0													6.0	
150.0													5.6	
155.0													5.2	
160.0													4.6	
165.0													4.2	
170.0														





THIS CHART IS ONLY A GUIDE AND SHOULD NOT BE USED TO OPERATE THE CRANE.



The individual crane's load chart, operating instructions and other instructional plates must be read and understood prior to operating the crane.

Load charts

Integrated heavy duty jib





Intermediate angle



 11,7 m - 60 m (38 ft - 196.9 ft)
  3,3 m (10.8 ft)
  22 700 kg (50,000 lb)
  25.6 ft x 24.6 ft spread (100%)
  360°

  Pounds x 1000

Feet	38.2' + 10.8'			64.9' + 10.8'			91.4' + 10.8'			117.6' + 10.8'			145.3' + 10.8'			172.0' + 10.8'			196.9' + 10.8'		
	0°	20°	40°	0°	20°	40°	0°	20°	40°	0°	20°	40°	0°	20°	40°	0°	20°	40°	0°	20°	40°
10.0	73.0	73.0	73.0			73.0															
15.0	71.0	65.0	66.0			73.0															
20.0	60.0	57.0	59.0	73.0	71.0	70.0			57.0			41.0									
25.0	51.0	51.0	55.0	71.0	65.0	65.0	73.0	68.0	57.0			41.0			27.4						
30.0	45.0	46.0		63.0	59.0	61.0	64.0	64.0	57.0	49.0	46.0	41.0			27.4				17.6		
35.0	40.2	42.6		57.0	55.0	58.0	58.0	57.0	57.0	46.0	43.6	41.0			27.4				17.6		
40.0				52.0	51.0	52.0	50.0	50.0	50.0	43.2	41.2	41.0	32.8	29.6	27.4				17.6		11.0
45.0				45.0	45.0	45.0	42.6	42.6	43.0	39.8	38.8	39.4	32.8	29.6	27.4	20.0	18.0	17.6			11.0
50.0				39.0	39.0		37.0	37.0	37.2	34.4	34.6	34.8	30.6	29.6	27.4	20.0	18.0	17.6	12.6	11.0	11.0
55.0				33.4	33.4		32.2	32.2	32.6	30.2	30.2	30.6	27.0	27.0	27.2	20.0	18.0	17.6	12.6	11.0	11.0
60.0				29.0			28.4	28.4	28.6	26.6	26.6	26.8	23.6	23.6	23.8	20.0	18.0	17.6	12.6	11.0	11.0
65.0				25.2			25.2	25.2	25.4	23.6	23.6	23.8	20.8	20.8	21.0	20.0	18.0	17.6	12.6	11.0	11.0
70.0							22.2	22.2		21.0	21.0	21.2	18.4	18.4	18.6	18.0	18.0	17.6	12.6	11.0	11.0
75.0							19.6	19.6		18.8	18.8	19.0	16.2	16.2	16.4	16.0	16.0	16.2	12.6	11.0	11.0
80.0							17.4	17.4		16.8	16.8	17.0	14.4	14.4	14.6	14.2	14.2	14.4	12.6	11.0	11.0
85.0							15.4	15.4		15.0	15.2	15.2	12.8	12.8	12.8	12.6	12.6	12.8	12.6	11.0	11.0
90.0										13.4	13.4		11.4	11.4	11.4	11.4	11.4	11.8	11.8	11.0	11.0
95.0										11.8	11.8		10.0	10.0	10.0	10.6	10.8	10.8	10.6	10.8	10.8
100.0										10.4	10.6		8.8	8.8	8.8	10.0	10.0	10.2	9.4	9.6	9.8
105.0										9.2	9.4		8.0	8.0	8.2	9.2	9.4	9.4	8.4	8.6	8.6
110.0										8.2	8.2		7.6	7.6	7.6	8.6	8.8	8.8	7.4	7.6	7.8
115.0													7.0	7.0		8.2	8.2	8.2	6.6	6.8	6.8
120.0													6.6	6.6		7.6	7.6	7.6	5.8	6.0	6.0
125.0													6.2	6.2		7.2	7.2	7.2	5.2	5.2	5.4
130.0													5.8	5.8		6.4	6.4	6.4	4.4	4.6	4.6
135.0													5.4	2.6		5.6	5.6		3.8	4.0	4.0
140.0																5.0	5.0		3.2	3.4	3.4
145.0																4.4	4.4		2.8	2.8	2.8
150.0																3.8	3.8		2.2	2.4	2.4
155.0																3.4	3.4		1.8	2.0	2.0
160.0																			2.8		

Loads for luffing

 11,7 m - 60 m (38 ft - 196.9 ft)
  3,3 m (10.8 ft)
  27 100 kg (59,700 lb)
  25.6 ft x 24.6 ft spread (100%)
  360°

































  Pounds x 1000

Feet	38.2' + 10.8'		64.9' + 10.8'		91.4' + 10.8'		117.6' + 10.8'		145.3' + 10.8'		172.0' + 10.8'		196.9' + 10.8'	
	0°-20°	20°-40°	0°-20°	20°-40°	0°-20°	20°-40°	0°-20°	20°-40°	0°-20°	20°-40°	0°-20°	20°-40°	0°-20°	20°-40°
10.0	46.0	46.0												
15.0	43.4	44.0												
20.0	40.6	43.0	45.0	45.0			46.0			39.0				
25.0	38.6	42.8	43.8	44.0	45.0	45.0				39.0		26.0		
30.0	37.2		41.8	43.2	45.0	45.0	43.8	39.0				26.0		17.2
35.0	36.6		40.2	42.8	43.8	44.0	41.6	39.0				26.0		17.2
40.0			38.8	42.6	42.4	43.4	39.2	39.0				26.0		17.2
45.0			37.8	42.8	41.0	43.0	36.8	37.6	29.6	26.0		18.0	17.2	
50.0				36.0	36.0	36.4	34.8	34.8	29.0	26.0		18.0	17.2	10.8
55.0				30.6	30.8	31.0	30.2	30.6	27.0	26.0		18.0	17.2	10.8
60.0					26.6	26.6	26.4	26.6	23.6	23.8		18.0	17.2	10.8
65.0					23.2	23.2	23.0	23.0	20.8	21.0		18.0	17.2	10.8
70.0					20.2		20.0	20.2	18.4	18.6		18.0	17.2	10.8
75.0					17.8		17.6	17.8	16.2	16.4		16.0	16.2	10.8
80.0					15.8		15.6	15.6	14.2	14.4		14.2	14.4	10.8
85.0						14.0			13.8	13.8		12.4	12.6	10.8
90.0									12.2	10.8		11.0	11.0	10.8
95.0									9.4	9.6		10.2	10.4	10.8
100.0									8.6	8.4		9.7	9.6	9.6
105.0									8.4	8.4		8.8	9.0	8.6
110.0									7.6			8.4	8.4	7.6
115.0												7.8	7.8	6.8
120.0												7.2	7.2	6.0
125.0												6.6	6.6	5.2
130.0												5.8	5.8	4.6
135.0												5.2		3.8
140.0												4.6		3.2
145.0												4.0		2.8
150.0												3.6		2.2
155.0												3.0		1.8

THIS CHART IS ONLY A GUIDE AND SHOULD NOT BE USED TO OPERATE THE CRANE.

The individual crane's load chart, operating instructions and other instructional plates must be read and understood prior to operating the crane.

Symbols glossary

 Axles	 Counterweight	 Grade	 Radius
 Boom	 Drive	 Hoist	 Rotation
 Boom elevation	 Electrical system	 Hookblock	 Speed
 Boom extension	 Engine	 Hydraulic system	 Steering
 Boom length	 Extension	 Lights	 Suspension
 Boom nose	 Frame	 Oil	 Swing
 Brakes	 Fuel tank capacity	 Outrigger controls	 Tires
 Cab	 Gear	 Outriggers	 Transmission

Notes

Manitowoc Cranes

Regional headquarters

Americas

Manitowoc, Wisconsin, USA

Tel: +1 920 684 6621

Fax: +1 920 683 6277

Shady Grove, Pennsylvania, USA

Tel: +1 717 597 8121

Fax: +1 717 597 4062

Europe, Middle East, Africa

Dardilly, France

Tel: +33 (0)4 72 18 20 20

Fax: +33 (0)4 72 18 20 00

China

Shanghai, China

Tel: +86 21 6457 0066

Fax: +86 21 6457 4955

Greater Asia-Pacific

Singapore

Tel: +65 6264 1188

Fax: +65 6862 4040

Regional offices

Americas

Brazil

Alphaville

Mexico

Monterrey

Chile

Santiago

Europe, Middle East,

Africa

France

Dardilly

Saint Pierre de Chandieu

Germany

Langenfeld

Italy

Lainate

Netherlands

Breda

Poland

Warsaw

Portugal

Baltar

Russia

Moscow

South Africa

Johannesburg

U.A.E.

Dubai

U.K.

Buckingham

China

Beijing

Chengdu

Guangzhou

Xian

Greater Asia-Pacific

Australia

Brisbane

Sydney

India

Ahmedabad

Bengaluru

Chennai

Gurgaon

Hyderabad

Kolkata

Mumbai

Noida

Pune

Korea

Seoul

Philippines

Makati City

Singapore

Factories

Brazil

Passo Fundo

China

Zhangjiagang

France

Charlieu

Moulins

Germany

Wilhelmshaven

India

Pune

Italy

Niella Tanaro

Portugal

Baltar

Fânzeres

USA

Manitowoc

Port Washington

Shady Grove

This document is non-contractual. Constant improvement and engineering progress make it necessary that we reserve the right to make specification, equipment, and price changes without notice. Illustrations shown may include optional equipment and accessories and may not include all standard equipment.